

INFORMATION TECHNOLOGY INFRASTRUCTURE STANDARDS OF PRACTICE VOLUMES 1, 2, AND 3



Version 4.0 - 20160401

If you have any questions and/or comments,
please send an email to:

ITInfrastructureStds@lawa.org

AUTHOR
Mark Pohl, RCDD

EDITORS
Connie Kan, BSCE
Timothy Lue, MSEE, PE

REVISION HISTORY

Version	Date	Author/Editor	Sections	Description
1.0	3/02/01	Mark Pohl	New	Original Document
2.0	10/22/04	Mark Pohl	All	Complete Rewrite
3.0	4/1/11	Mark Pohl Brian Brenton	Update Elec/Mech	Standards update Added new UPS and HVAC requirements
3.1	9/7/12	Scott Lewis	All	ADG inputs and formatting
3.2	5/20/14	Judith Villanueva	Cabling	Copper/Innerduct Changes & Bend Insensitive Fiber Update
4.0	4/01/16	Mark Pohl Petro Villafana	All	Complete Rewrite & Drawings Surveys, Photography, & Drawings
4.0	7/5/16	Mark Pohl/Nathan Look/Tim Lue	Vol. 3 Appendix N Fiber Cable	Situations where it is acceptable to use non-Corning fiber cable.
4.0	7/18/16	Mark Pohl/Nathan Look/Tim Lue	HVAC	2.11.6 and 2.22.6 - Chilled water acceptable on primary air conditioning units only. DX units are required for backup air conditioning. All MPOE's and IT Rooms shall have both.

ACKNOWLEDGEMENTS

Los Angeles World Airports (LAWA) Information Management and Technology Group (IMTG) would like to acknowledge the following groups for their contribution to these Standards of Practice (SOP).

- Contributors - Wilmore Villanueva, Alner Cobarrubia, Wally Argueta, and Trien Nguyen.
- BICSI - For the ceaseless efforts of the members who constantly improve the state of the art of Telecommunications Distribution Methods, Outside Plant, and for their contribution to this document.
- Office of Airport Technology & Business Systems - For their contribution of Field Surveys, GIS support, and review and comments on the Standards.
- Office of Infrastructure Technology - For researching, analyzing, specifying, and preparing the information contained herein and review and commenting on the Standards.
- Office of IT Administration - For oversight on contracts and supplies necessary for this manual.
- Office of IT Planning and Client Services - For their contribution of workstations and applications, Enterprise Architecture, Common Use, and comments on the Standards.
- Office of Information Security - For their contribution of physical security.
- Vendors, Consultants, and Contractors - For their research and information contributions.

**INFORMATION
TECHNOLOGY
INFRASTRUCTURE
STANDARDS OF PRACTICE**

**VOLUME 1 OF 3
INTRODUCTION
LOCATIONS & SPACES**

TABLE OF CONTENTS

1. INTRODUCTION	13
1.1. WHO IS THE AUDIENCE?	13
1.2. WHAT IS A STANDARD?	13
1.3. WHAT ARE THE OBJECTIVES OF A STANDARD?	13
1.4. WHERE DO STANDARDS FIT IN IT?	13
1.5. ADHERENCE TO LAWA STANDARDS RESULTS IN?	13
1.6. WHAT IS IT INFRASTRUCTURE?	14
2. LOCATIONS & SPACES (L&S)	17
2.1. L&S > GENERAL OVERVIEW	17
2.2. L&S > CONSTRUCTION	19
2.3. L&S > RENOVATIONS	22
2.4. L&S > MPOE'S > SPACE PLANNING	22
2.5. L&S > MPOE'S > LAYOUT	24
2.6. L&S > MPOE'S > DIMENSIONS	26
2.7. L&S > MPOE'S > ELECTRICAL	29
2.8. L&S > MPOE'S > UPS > GENERAL	29
2.9. L&S > MPOE'S > UPS > 208V SYSTEMS	30
2.10. L&S > MPOE'S > UPS > 480V SYSTEMS	31
2.11. L&S > MPOE'S > HVAC	31
2.12. L&S > IT ROOMS > SPACE PLANNING PARAMETERS	34
2.13. L&S > IT ROOMS > SPACE PLANNING	36
2.14. L&S > IT ROOMS > LAYOUT	39
2.15. L&S > IT ROOMS > DIMENSIONS	41
2.16. L&S > IT ROOMS > PLANNING MULTI-STORY SPACES	43
2.17. L&S > IT ROOMS > ELECTRICAL	48
2.18. L&S > IT ROOMS > UPS > 208 VOLT SYSTEMS	49
2.19. L&S > IT ROOMS > UPS > 480 VOLT SYSTEMS	52
2.20. L&S > IT ROOMS > UPS > SMALLER IT ROOMS GENERAL	53
2.21. L&S > IT ROOMS > UPS > WITHIN EQUIPMENT CABINETS	53
2.22. L&S > IT ROOMS > HVAC	54
2.23. L&S > SERVICE PROVIDERS > SPACE PLANNING	55
2.24. L&S > SERVICE PROVIDERS > ELECTRICAL	57
2.25. L&S > SERVICE PROVIDERS > HVAC	58



2.26.	L&S > TENANT COMMON-USE WIRING CLOSETS-----	59
2.27.	L&S > TELECOMMUNICATIONS ENCLOSURES > INDOOR-----	61
2.28.	L&S > TELECOMMUNICATIONS ENCLOSURES > OUTDOOR-----	64
2.29.	L&S > HAND HOLES-----	74
2.30.	L&S > HAND HOLES > SPACING-----	77
2.31.	L&S > MAINTENANCE HOLES-----	78
2.32.	L&S > MAINTENANCE HOLES > SPACING-----	83
2.33.	L&S > DATA CENTERS-----	84
2.34.	L&S > DATA CENTERS > ACCESS FLOOR-----	87
2.35.	L&S > DISTRIBUTED ANTENNA SYSTEM IT ROOMS-----	90
2.36.	L&S > COMMON ELEMENTS-----	93
2.37.	L&S > COMMON ELEMENTS > ACCESS-----	94
2.38.	L&S > COMMON ELEMENTS > ACCESS POLICY-----	105
2.39.	L&S > COMMON ELEMENTS > ACCESS FLOORS-----	105
2.40.	L&S > COMMON ELEMENTS > CABINETS-----	108
2.41.	L&S > COMMON ELEMENTS > CABINETS > CONDUIT-----	115
2.42.	L&S > COMMON ELEMENTS > CABINETS > ELECTRICAL-----	116
2.43.	L&S > COMMON ELEMENTS > CABINETS > GROUNDING-----	122
2.44.	L&S > COMMON ELEMENTS > CABINETS > LIGHTING-----	123
2.45.	L&S > COMMON ELEMENTS > CEILINGS-----	125
2.46.	L&S > COMMON ELEMENTS > DIVIDERS-----	127
2.47.	L&S > COMMON ELEMENTS > DOORS-----	130
2.48.	L&S > COMMON ELEMENTS > ELECTRICAL-----	131
2.49.	L&S > COMMON ELEMENTS > ELECTROMAGNETIC RADIATION-----	134
2.50.	L&S > COMMON ELEMENTS > ENVIRONMENTAL MONITORING-----	135
2.51.	L&S > COMMON ELEMENTS > EQUIPMENT RACKS-----	136
2.52.	L&S > COMMON ELEMENTS > FIRE PROTECTION-----	139
2.53.	L&S > COMMON ELEMENTS > FLOORS-----	143
2.54.	L&S > COMMON ELEMENTS > GROUNDING FOR NEW FACILITIES-----	145
2.55.	L&S > COMMON ELEMENTS > GROUNDING EXISTING FACILITIES-----	150
2.56.	L&S > COMMON ELEMENTS > HAZARDOUS MATERIALS-----	153
2.57.	L&S > COMMON ELEMENTS > HVAC REMOTE MONITORING-----	154
2.58.	L&S > COMMON ELEMENTS > LIGHTING-----	155
2.59.	L&S > COMMON ELEMENTS > LIQUIDS-----	156
2.60.	L&S > COMMON ELEMENTS > POSITIVE PRESSURE VENTILATION-----	160



2.61.	L&S > COMMON ELEMENTS > SECURITY MONITORING-----	161
2.62.	L&S > COMMON ELEMENTS > SEISMIC ANCHORING-----	162
2.63.	L&S > COMMON ELEMENTS > TELEPHONES-----	165
2.64.	L&S > COMMON ELEMENTS > UPS > SIZING-----	166
2.65.	L&S > COMMON ELEMENTS > UPS > GENERAL-----	166
2.66.	L&S > COMMON ELEMENTS > WALLS-----	167
2.67.	L&S > COMMON ELEMENTS > WINDOWS-----	169

1. INTRODUCTION

1.1. WHO IS THE AUDIENCE?

- 1.1.1. This document serves as a reference for designers providing Information Technology (IT) Infrastructure, IT Systems, and IT-related facilities and utilities. This document is also a reference for inspectors of IT projects or projects that have an IT component and for IT staff performing daily operations and maintenance of IT infrastructure and systems.
- 1.1.2. In this document and by consensus adoption within the organization, the term "IT" is used in place of the term "Information Technology" or "Telecommunications" for its brevity and updated connotation.

1.2. WHAT IS A STANDARD?

Per the International Standards Organization, "A standard is a document that provides requirements, specifications, guidelines or characteristics that can be used consistently to ensure that materials, products, processes and services are fit for their purpose." <http://www.iso.org/iso/home/standards.htm>

1.3. WHAT ARE THE OBJECTIVES OF A STANDARD?

"... Standards ensure that products and services are safe, reliable and of good quality. For business, they are strategic tools that reduce costs by minimizing waste and errors, and increasing productivity ..."
<http://www.iso.org/iso/home/standards.htm>

1.4. WHERE DO STANDARDS FIT IN IT?

The pyramid shown herein depicts how standards are the foundation of Information Technology. The focus of this manual addresses Standards for Infrastructure that supports networks and systems.

1.5. ADHERENCE TO LAWA STANDARDS RESULTS IN?

Adherence to this document and the referenced standards will result in IT infrastructure and systems that are reliable, scalable, secure, serviceable, and conform to industry best practices as adopted by LAWA.

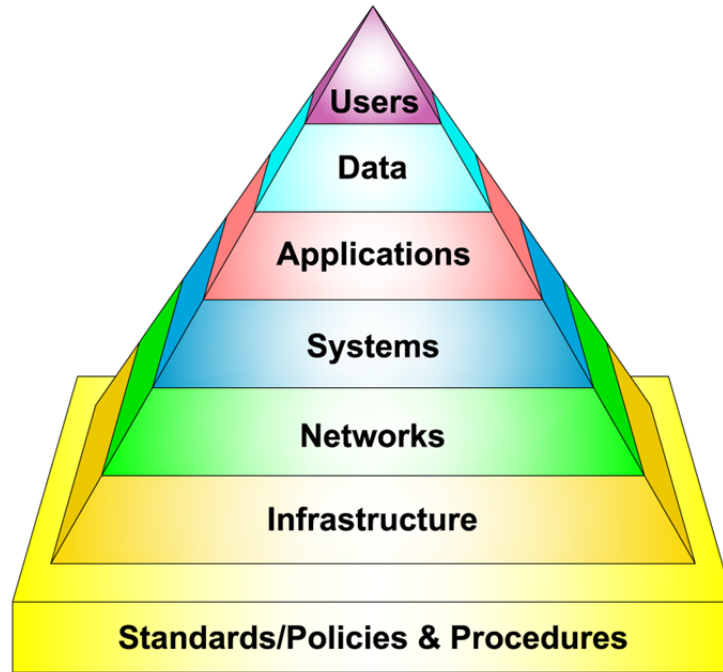

Pyramid of Information Technology.

1.6. WHAT IS IT INFRASTRUCTURE?

IT Infrastructure is the locations, spaces, backbone distribution, horizontal distribution, pathways, and cables required to support networks, IT systems, and their associated equipment and applications for business operations.

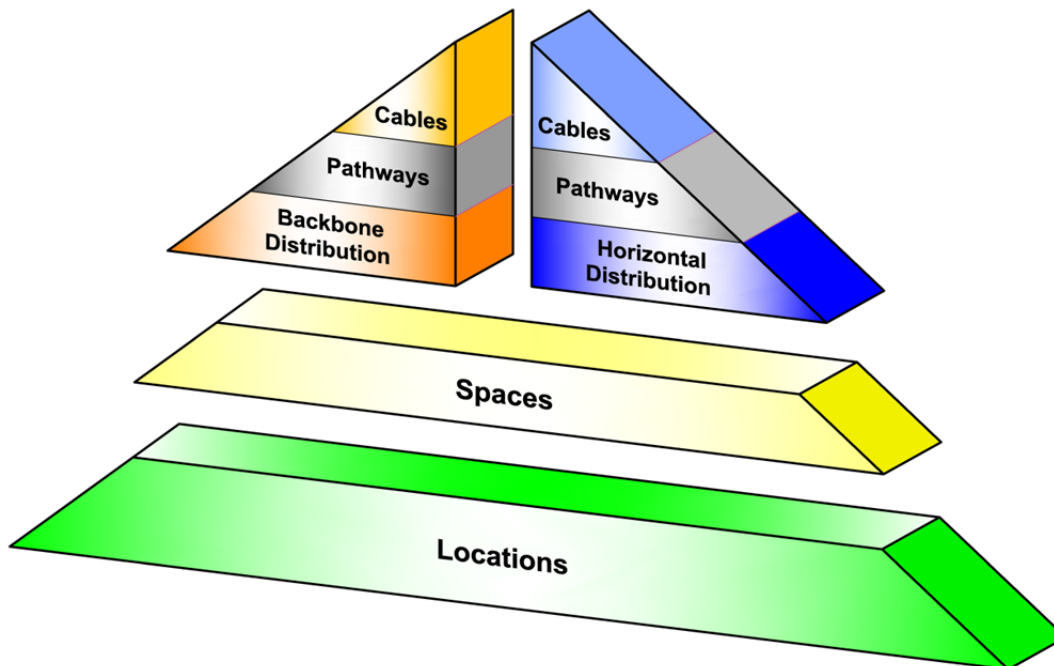

Pyramid of Infrastructure - Expanded from the Pyramid of IT Infrastructure Layer.

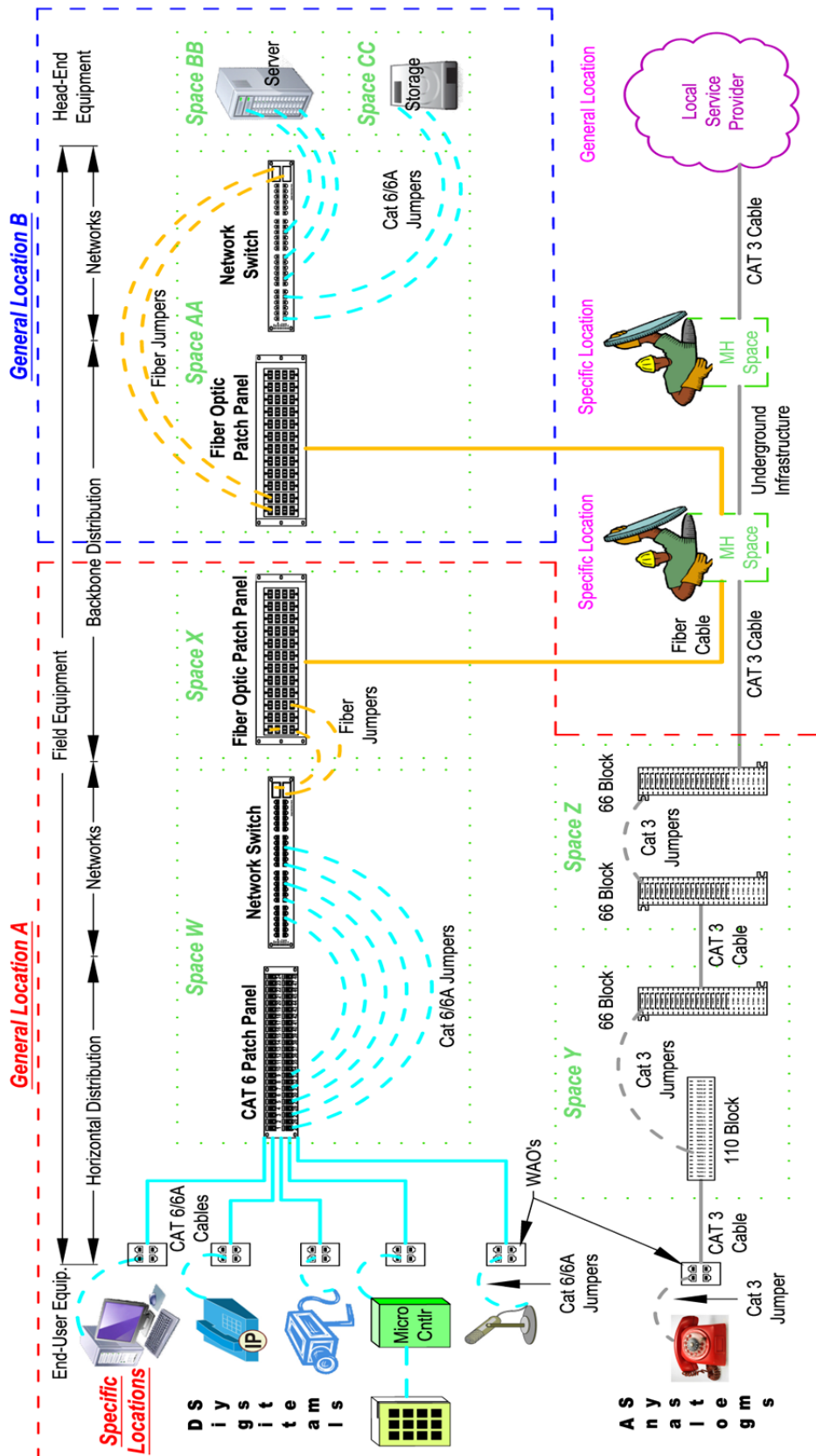

Singleline diagram illustrating the pyramid of IT.

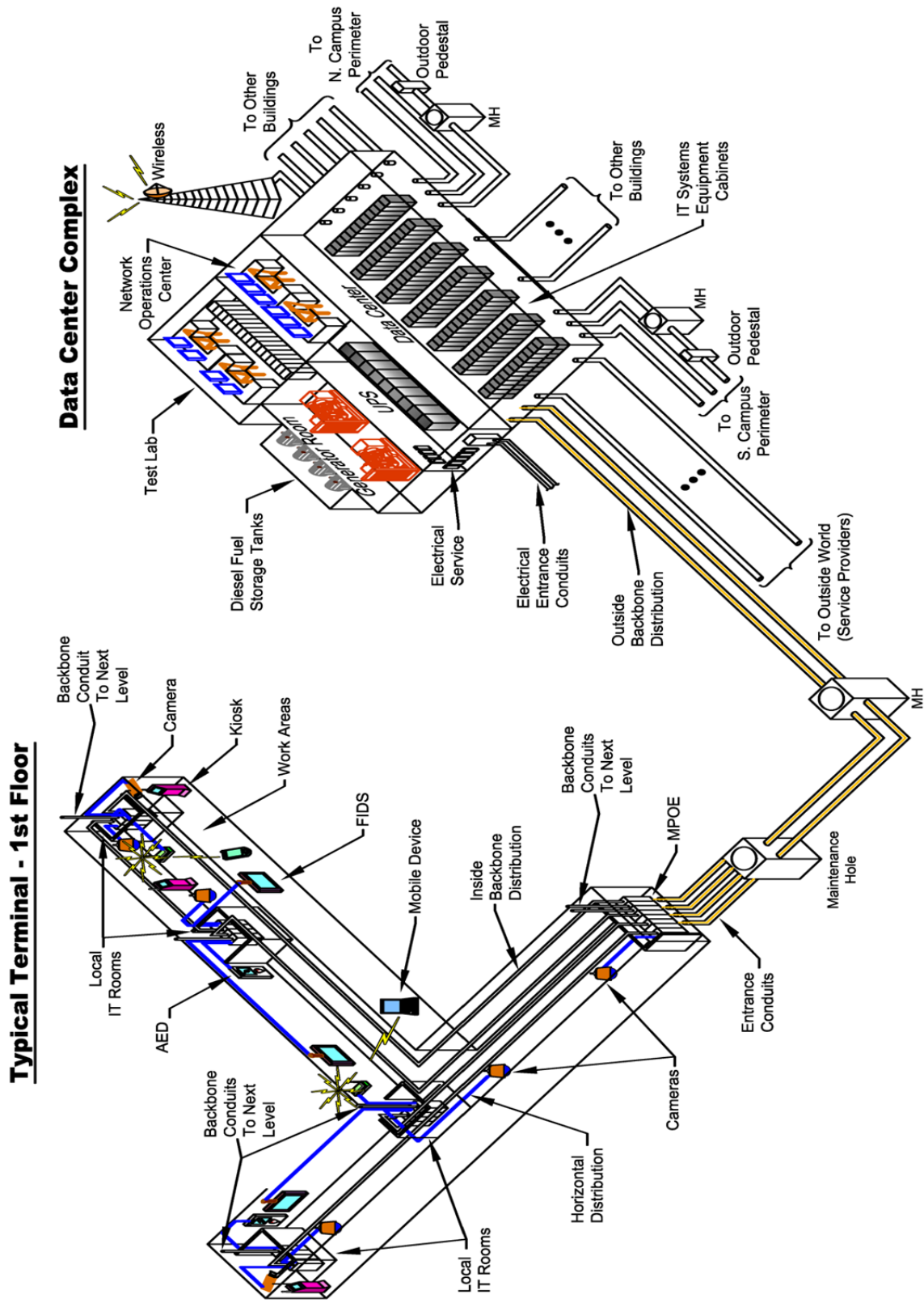

Typical layout of IT System Infrastructure.

2. LOCATIONS & SPACES (L&S)

2.1. L&S > GENERAL OVERVIEW

- 2.1.1. All IT Systems have origin and destination *Locations*. *IT Locations* are general and/or specific geographic areas. *Locations* can be indoor, outdoor, or both, and can also be within the airport or outside of the airport. *Locations* must be defined before the pathways and cabling that connect them together can be designed, and before the network and systems equipment can be installed.
- 2.1.2. Types of *Locations* include:
- Physical description
 - Latitude and longitude coordinates
 - State Plane coordinates
 - Street addresses or intersections
 - Building Name, Level, and Room No.
- 2.1.3. Examples of *Locations* include:
- Tom Bradley International Terminal; Central Terminal Area; Sand Dunes
 - 33.9425°N, 118.4081° W
 - 0405 6437886.398ftUSE 1801707.943ftUSN
 - 300 feet south of a street intersection
 - Admin East, 12th floor, room 1208; Guard Post No. 6; Fire Station No. 1
- 2.1.4. *IT Locations* have *IT Spaces*. *IT Spaces* are specific areas within *Locations* where cabling terminates and/or equipment is installed. *IT Spaces* are connected by pathways. *IT Spaces* can be as small as a termination block or as large as a building - like a data center.
- 2.1.5. Examples of *IT Spaces* include:
- IT Rooms, IT Closets, and Data Centers
 - Tenant IT Rooms and Common-Use Wiring Closets
 - IT Equipment cabinets, enclosures, and junction boxes
 - Pedestals, maintenance holes, and hand-holes
- 2.1.6. Typically, *Locations* with *IT Spaces* are divided into origins (containing end-user equipment), destinations (containing head-end equipment), and field (containing any equipment between the end-user and head-end equipment).

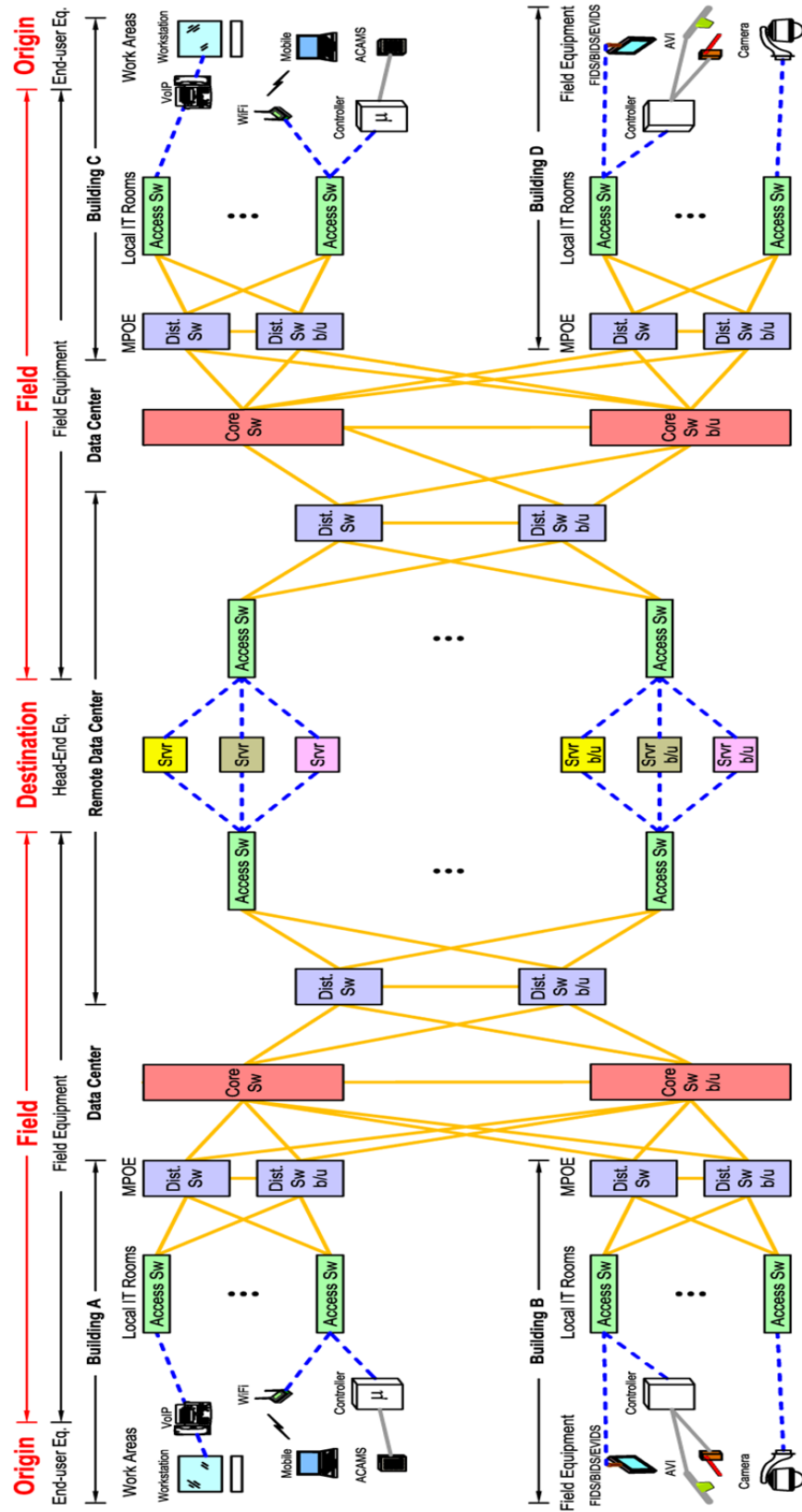

The distinction between origin, field, and destination of Locations & Spaces.

2.1.7. *IT Spaces* may require:

- Electrical power
- Uninterruptible power supplies (UPS)
- Telecommunications Grounding
- Lighting
- Air conditioning
- Fire protection
- Entrance Facilities
- Service Providers
- Secured Access
- Security monitoring

2.1.8. *End-Users* are usually located in work areas. A work area is an area where there is end-user equipment.

2.2. L&S > CONSTRUCTION

2.2.1. MPOE and IT Rooms shall be constructed of the same building materials as surrounding architecture with the exception of ceilings. Ceiling shall be open for access.

2.2.2. MPOE and IT Room floor loading capacity shall be a minimum of 100 lb./ft².

2.2.3. All IT pathways shall be protected in place in a construction environment.

2.2.4. All IT equipment cabinets and equipment shall be wrapped in a protective wrap to keep the dust and dirt out.

2.2.5. All IT cabinets with active equipment dissipating heat shall be cooled at all times.



IT cabinets in construction zones shall be protected and cooled.



Enlargement of a cabinet protected and cooled within a fabricated PVC and plastic frame.

2.3. L&S > RENOVATIONS

- 2.3.1. IT Room renovations that have plumbing in the ceiling should have that plumbing rerouted away from the space. If re-routing is not possible, then equipment cabinets and wall-mounted equipment shall be protected by installing aluminum sheet metal collector and deflector pans to channel water away from equipment cabinets and wall-mounted equipment.
- 2.3.2. IT cabinets and equipment shall not be moved without LAWA approval.
- 2.3.3. All IT equipment shall be protected in place during survey, discovery, construction, bypass, and cutovers.
- 2.3.4. All IT equipment cabinets shall be wrapped in a protective wrap to keep out dust and dirt.
- 2.3.5. All IT cabinets with active equipment shall be kept cool during renovation.
- 2.3.6. After renovation, all equipment cabinets should be restored to pre-renovation condition and all dust and debris shall be removed.

2.4. L&S > MPOE'S > SPACE PLANNING

- 2.4.1. The primary Minimum Point Of Entry (MPOE) is the crossing point where the Service Provider's cable enters the building, which terminates in the main telephone rooms. This main telephone room is defined by LAWA as the MPOE.
- 2.4.2. All Service Provider cables terminate in the MPOE at a point called the demarcation (demarc) point. The demarc is the point of hand-off to LAWA or the Tenant.
- 2.4.3. A secondary MPOE is an extension of the primary MPOE.
- 2.4.4. New facilities shall have a new MPOE and/or a secondary MPOE. A secondary MPOE is usually installed if it is an extension of another facility.
- 2.4.5. New MPOE's should be centrally located on the longest perimeter wall of the building, away from sources of Electromagnetic Interference (EMI), and close to the incoming underground ductbanks.

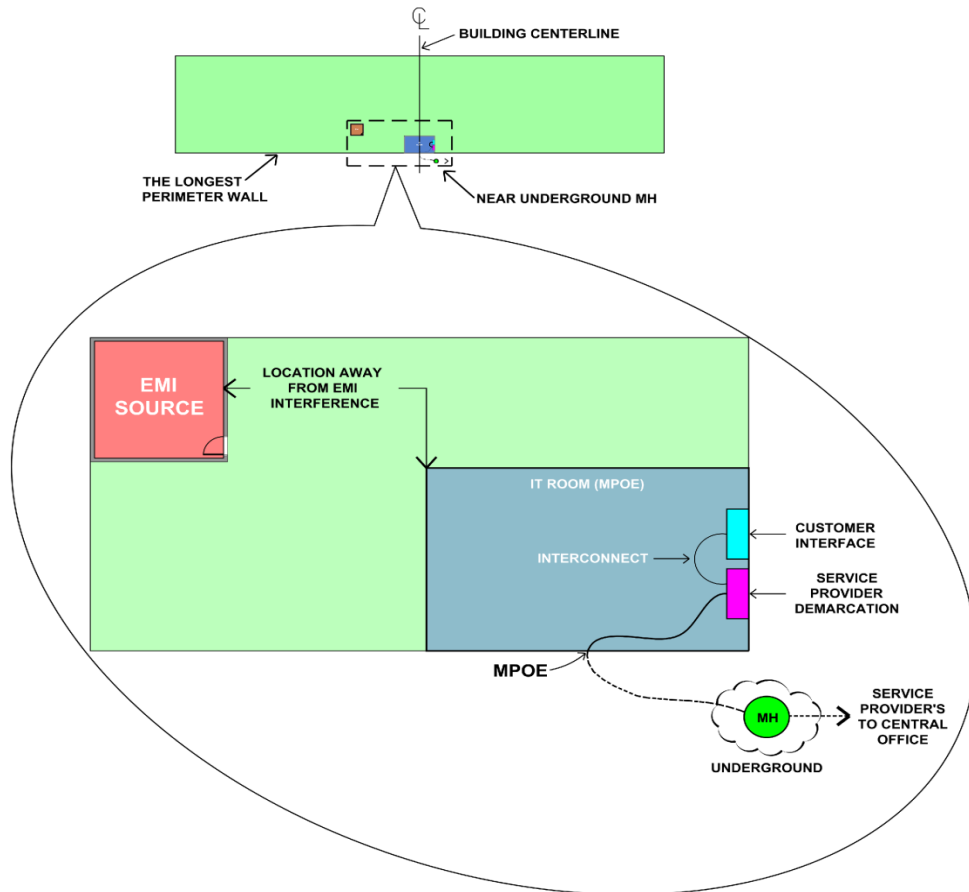

The Minimum Point of Entry.



The Minimum Point of Entry shown in a perimeter wall.

- 2.4.6. The immediate environment surrounding an MPOE shall not contain liquid-carrying equipment such as steam boilers, compressors, elevator equipment, electrical co-generation equipment, concessions, restaurants, waste handling, or chilled/hot water pipes that serve areas other than the MPOE. Nor shall any sewer line be anywhere near the MPOE.
- 2.4.7. MPOE's shall be located above any potential flood zones.
- 2.4.8. The MPOE shall be located away from flying dirt and debris (e.g. ramp areas). MPOE's shall have positive pressure ventilation and gasketing.
- 2.4.9. MPOE's shall be accessible:
- Without entering any tenant-occupied space
 - Without passing through other utility or mechanical rooms
 - From a corridor, stairwell, and/or a service elevator large enough for equipment cabinet loading, unloading, and servicing

2.5. L&S > MPOE'S > LAYOUT

- 2.5.1. New building MPOE's should be located on the longest perimeter wall, near the center of the building, away from sources of EMI, and near access to the underground duct banks.
- 2.5.2. The location and quantity of telecommunications rooms shall be designed so that the maximum distance from the IT room to any field device that the room supports shall not exceed 200 feet via the longest possible route (i.e. right angles) traveled by the cable from the room to the field device. This includes all work area outlets, ACAMS card readers, cameras, access points, displays, antennas, etc.
- 2.5.3. The environment in the MPOE room shall be free from electromagnetic interference. Radio Frequency Interference (RFI) shielding shall be employed if needed.
- 2.5.4. The immediate environment surrounding an MPOE cannot contain liquid-carrying equipment such as steam boilers, compressors, chilled/hot water pipes that serve areas other than the MPOE, elevator equipment, electrical co-generation equipment, concessions, restaurants, or waste handling.
- 2.5.5. MPOE's shall be located above any potential flood zones.
- 2.5.6. MPOE's shall not be located adjacent to or below rest rooms and restaurants.
- 2.5.7. MPOE rooms shall be located away from flying dirt and debris (e.g. airline equipment ramps). If that is not feasible, then MPOE's shall have positive ventilation and magnetic gasketing.
- 2.5.8. MPOE's shall be accessible from a corridor, stairwell, and/or a service elevator large enough for cabinet and equipment loading, unloading, and servicing.

- 2.5.9. Within passenger terminals, MPOE's shall be sized to accommodate a minimum of eight (8) LAWA IT equipment cabinets, three (3) Service Provider cabinets, and two (2) Tenant cabinets (if applicable) for entrance facility equipment. These requirements are in addition to any space required for Mechanical, Electrical, Plumbing (MEP), UPS, and Fire Protection equipment. LAWA cabinets are to be separated from the Service Provider and Tenant cabinets.

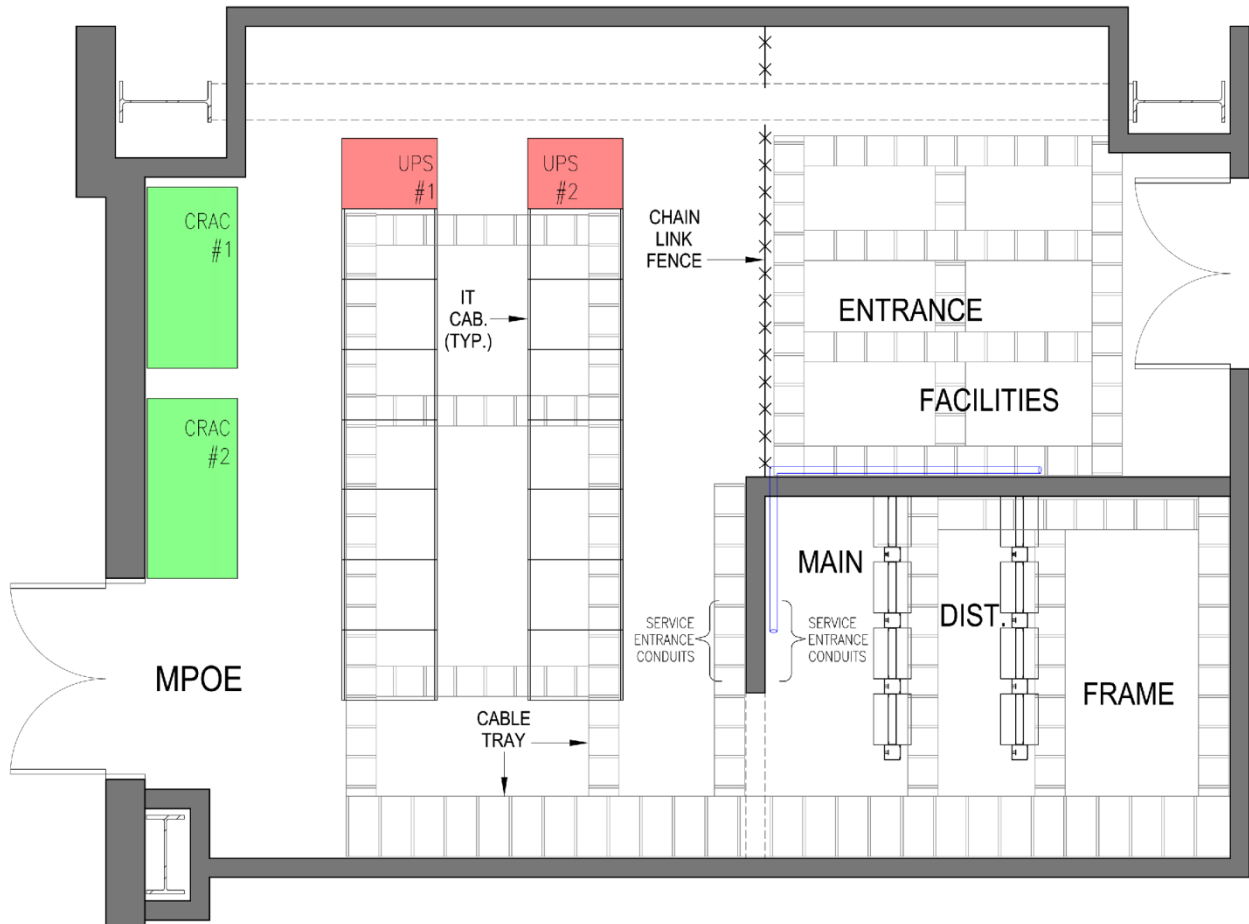

Legacy MPOE layout for a million square-foot terminal before utilities were required to be outside.

- 2.5.10. MPOE's should be square or rectangular in shape. "Square" MPOE's should have two rows of LAWA equipment cabinets. The base dimensions shown below are just for reference

2.6. L&S > MPOE'S > DIMENSIONS

- 2.6.1. MPOE's within passenger terminals shall have a minimum square footage of 300 unobstructed square feet. An IT Room that is proposed to be less than 300 sq. ft. will require a waiver approved by LAWA. This minimum 300 sq. ft. IT Room is for LAWA IT equipment use only and does not include space for backup power, air conditioning, fire protection, tenant or Service Providers equipment. This equipment should be located outside of the IT Room.
- 2.6.2. This minimum 300 sq. ft. IT Room shall have a minimum width of 11-feet and shall contain eight (8) equipment cabinets. Equipment cabinets shall be sized at a minimum of 34" W x 36" D x 84" H. Access between the equipment cabinet doors and the perimeter wall or equipment shall be 4 ft. minimum.

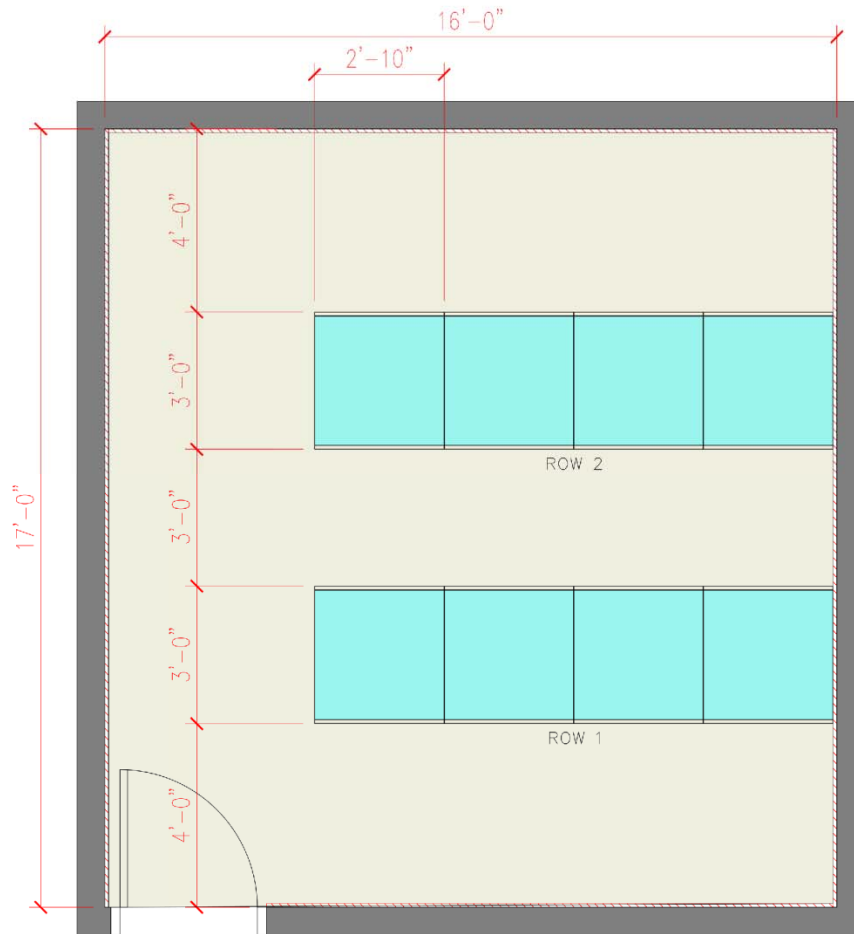

A square MPOE shown with minimum dimensions and without entrance facilities or utilities.

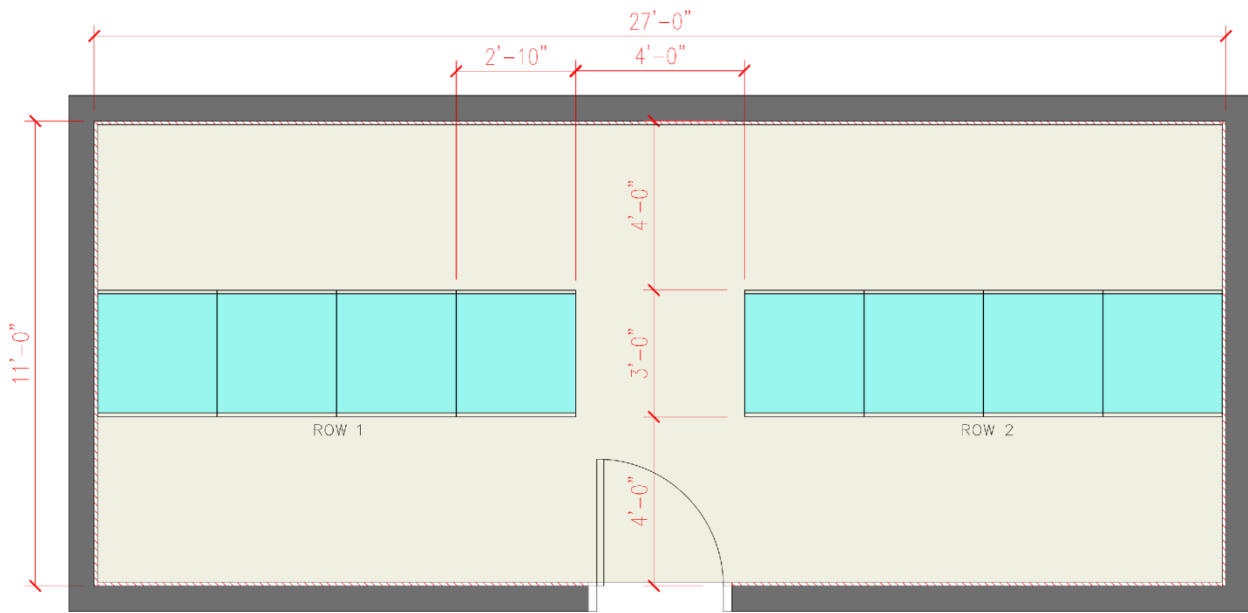

A rectangular MPOE shown with minimum dimensions and without entrance facilities or utilities.

- 2.6.3. Long rectangular rooms with one row of equipment cabinets may be divided in the middle for a door.
- 2.6.4. MPOE's in LAWA office buildings shall have a minimum square footage of not less than 300 unobstructed square feet. An IT Room that is proposed to be less than 300 sq. ft. will require a waiver approved by LAWA. This 300 sq. ft. IT Room is for LAWA IT equipment use only and does not include space for backup power, air conditioning, fire protection, tenant or Service Providers equipment. This equipment should be located outside of the IT Room.
- 2.6.5. IT Rooms in LAWA office buildings shall contain six (6) equipment cabinets. Equipment cabinets shall be sized at a minimum of 34" W x 36" D x 84" H. Access between the equipment cabinet doors and the perimeter wall or equipment shall be 4 ft. minimum.

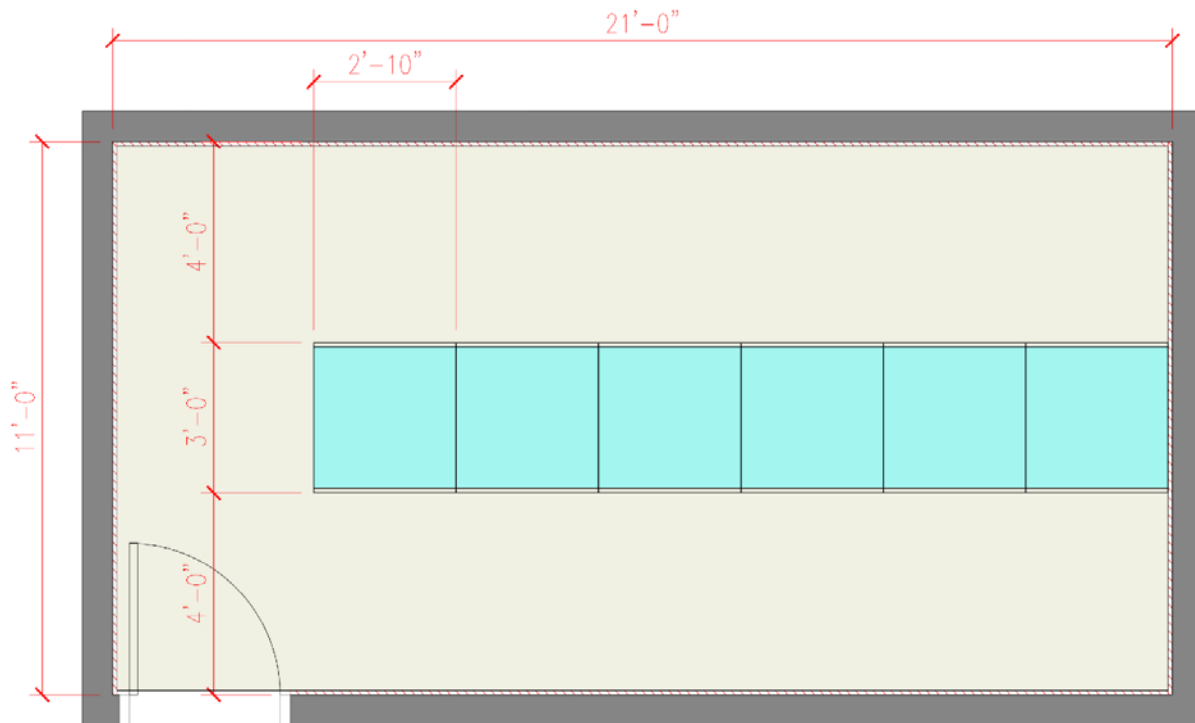

Minimum dimensions of an MPOE in a non-passenger terminal with 6 cabinets and no utilities.

- 2.6.6. IT Rooms that must contain architectural obstructions that cannot be avoided shall have their unobstructed square footage increased to compensate for the obstruction.

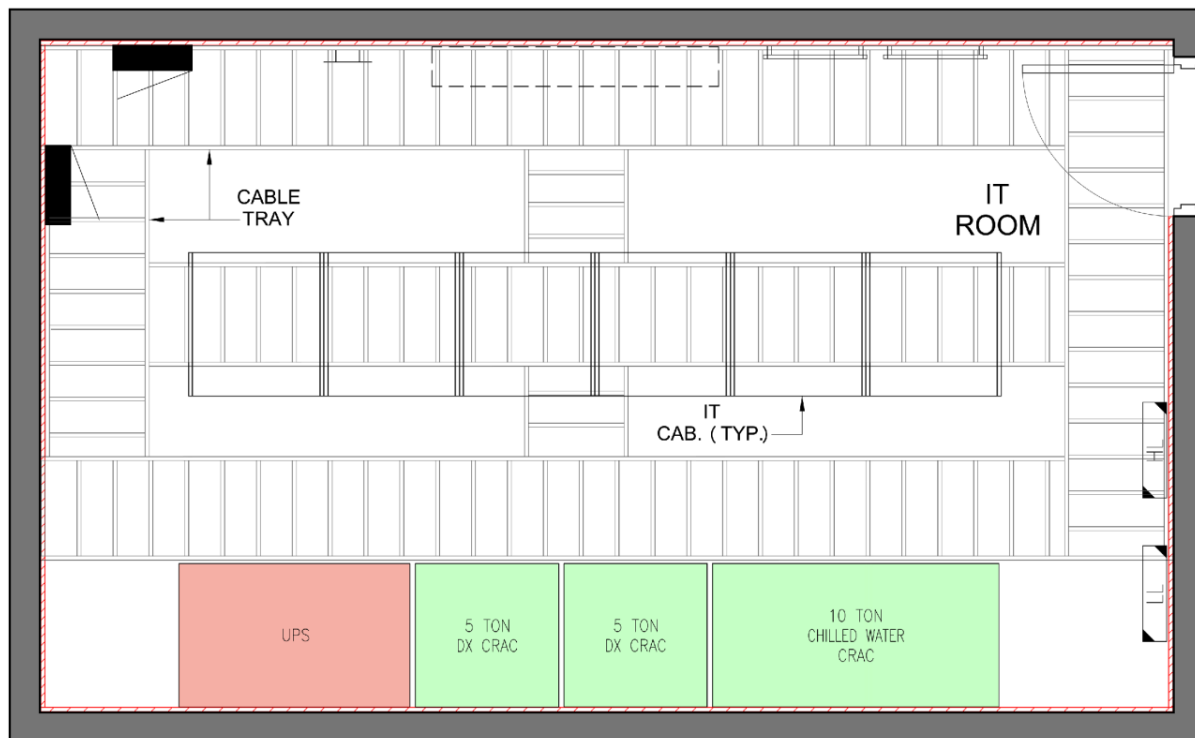

Legacy IT Room layout before utilities were required to be in a separate location.

2.7. L&S > MPOE'S > ELECTRICAL

2.7.1. All MPOE's shall have their own 208V, 3 phase, 4-wire, dedicated electrical panels and UPS panels. Calculations for electrical service for MPOE equipment shall be based on a minimum average of 2.8 kW per cabinet or rack.

2.7.2. A sample MPOE electrical calculation just for equipment cabinets is:

- 8 - LAWA equipment cabinets at 2.8 kW each = 22.4 kW
- 3 - Service Provider racks at 2.8 kW each = 8.4 kW
- 4 - Tenant Common-Use Wiring Closet ½-size cabinets with no loads

$$\text{Amps} = \frac{\text{kWatts} \times 1000}{\text{Voltage} \times \text{Power Factor} \times 1.73}$$

$$\text{Amps} = \frac{30.8 \times 1000}{120 \times 0.86 \times 1.73} = \mathbf{172.5 \text{ A}}$$

2.7.3. All MPOE's with eight (8) equipment cabinets shall have a minimum 225 Amp main circuit breaker (if not already de-rated to 80%) or a 175 Amp main circuit breaker (if already de-rated 80% like Cutler-Hammer) - unless equipment loads require adjustment.

2.7.4. The Telecommunications Main Grounding Busbar (TMGB) shall be bonded to the MPOE electrical panel ground located in the MPOE.

2.8. L&S > MPOE'S > UPS > GENERAL

2.8.1. MPOE UPS's (designed to service the entire MPOE, Entrance Facility, and MDF room) shall be installed in the electrical room or a room separate from but adjacent to the MPOE Room.

2.8.2. MPOE UPS's shall be backed up by the facility generator through an external Automatic Transfer Switch (ATS) that is installed in a room separate from the MPOE Room.

2.8.3. MPOE UPS's shall be provided with a Liebert SiteLink system allowing for communication with UPS's and Mechanical system components for integration with SITESCAN Web software via Transmission control Protocol/Internet Protocol (TCP/IP).

2.8.4. All MPOE and IT Room UPS shall be networked to the provided or existing/expanded Liebert SiteLink system.

2.9. L&S > MPOE'S > UPS > 208V SYSTEMS

- 2.9.1. Electrical – UPS, 208V Input (4 wire plus ground).
- 2.9.2. Calculations for Liebert UPS backup for MPOE equipment shall be based on a minimum average of 2.8 kW per cabinet or rack.
- 2.9.3. Provide (1) 30kVA/24kW 120/208V-input, 3-phase UPS, model Liebert NX 38SB030C0CHX or most current equivalent Liebert model per calculated load. Include internal VRLA battery capacity rated to 10 minutes at full load w/ disconnect facility for maintenance. UPS shall be packaged in a single 24" wide cabinet with automatic continuous static transfer switch and internal manual bypass. Include seismic anchoring and (1) OC-485 Webcard to interface w/ SiteLink system. Connect 120/208V output to single wall-mounted panelboard.



Calculated load for this MPOE required a 45kVA UPS.

- 2.9.4. Provide (1) external VRLA battery cabinet providing for a total of (26) minutes at 24kW load, model Liebert 38BP030RHX1BNR or most current equivalent Liebert model. Include DC cables so that 27" battery cabinet can be directly bolted to right side of UPS cabinet. Include seismic anchoring.
- 2.9.5. Provide (1) external maintenance bypass cabinet, model Liebert 38MB0300CC6AL or most current equivalent Liebert model. Include interconnecting cables for bolting to left side of UPS. Cabinet shall be 27" wide with single rotary switch interlocked for make-before-break manual transfers. Include seismic anchoring.

2.10. L&S > MPOE'S > UPS > 480V SYSTEMS

- 2.10.1. Electrical – UPS, 480V Input (3 wire plus ground).
- 2.10.2. Calculations for Liebert UPS backup for MPOE equipment shall be based on a minimum average of 2.8 kW per cabinet or rack.
- 2.10.3. Provide (1) 30kVA/24kW 480V-input, 120/208v output, 3-phase UPS, model Liebert NX 38SB030C0CHX or most current equivalent Liebert Model. Include internal VRLA battery capacity rated to 10 minutes at full load w/ disconnect facility for maintenance. UPS shall be packaged in a single 24" wide cabinet with automatic continuous static transfer switch and internal manual bypass. Include (1) OC-485 Webcard to interface w/ SiteLink system. Include (1) external maintenance bypass/transformer cabinet, model Liebert 38MB0300AC6DL or most current equivalent Liebert model. Include interconnecting cables for bolting to left side of UPS. Cabinet shall be 27" wide with 480V input isolation transformer and single rotary switch interlocked for make-before-break manual transfers. Include seismic anchoring for both cabinets. Connect 120/208V UPS output to single wall- mounted panelboard.
- 2.10.4. Provide (1) external VRLA battery cabinet providing for a total of (26) minutes at 24kW load, model Liebert 38BP030RHX1BNR or most current equivalent Liebert model. Include DC cables so that 27" battery cabinet can be directly bolted to right side of UPS cabinet. Include seismic anchoring.
- 2.10.5. **Note:** All references to model numbers and other pertinent information herein are intended to establish standards of performance, quality and construction. These model numbers are based on equipment manufactured by Liebert.

2.11. L&S > MPOE'S > HVAC

- 2.11.1. All MPOE's shall have primary chilled water air conditioning units, **and** backup air-cooled air conditioning units; each unit provided with leak detection. HVAC calculations shall be based on a minimum 2.8 kW per equipment cabinet or rack.
- 2.11.2. MPOE HVAC calculations are derived as follows: MPOE's (not data center) cabinet electrical usage was measured using a data logger in different locations with amp clamps at between 1.8 kW and 2.3 kW per cabinet. These numbers were averaged together and an additional allowance of 35% was added for future growth. 2.8 kW per cabinet was determined to be a baseline value for future growth.
- 2.11.3. MPOE HVAC requirements are calculated as follows:
 - 8 LAWA cabinets x 2.8kW = 22.4 kW
 - Service Provider (SP) requirements are included in the SP Section
 - 4 tenant cabinets with no active equipment (if adjacent to MPOE)

Heating

- 1 Watt electrical consumption = 3.41 BTU/hr.
- 22.4 kW x 3.41 = 76,384 BTU/hr. heating

Cooling

- 1 Ton of refrigeration = 12,000 BTU/hr. cooling
- 76,384 / 12,000 = 6.36 ton cooling

6.36 ton is rounded up to 8 ton.

- 2.11.4. MPOE's shall have Liebert PCW029 chilled water 8 ton units or most current equivalent Liebert model, as the primary system, **and** one (1) Liebert PDX PX029 direct expansion 8 ton unit or most current equivalent Liebert model, as the backup system for air conditioning unless calculated loads determine that multiple combinations of Liebert PW017, PW029, PX018, PX023, or PX029 units are required. Back-up units shall not have chilled water. The back-up unit shall have a 3-year preventative warranty purchased with the unit.
- 2.11.5. If Service Provider equipment is included, then increase air conditioning by 3 ton.
- 2.11.6. Chilled water pipes shall be kept to a minimum, follow and remain within twelve inches of perimeter walls for their pathways until connecting to equipment. Chilled water pipes shall not be installed above equipment or equipment cabinets.
- 2.11.7. Final acceptance and commissioning requirements for MPOE HVAC shall include testing of:
 - System and air balance
 - Interface with the Building Automation System (BAS)
 - Interface with the Fire Life Safety System (FLSS)
 - HVAC system
 - IT monitoring system.
- 2.11.8. All testing shall be performed by the manufacturer's representative(s).



Liebert PDX model air conditioner for MPOE's and local IT Rooms.

2.12. L&S > IT ROOMS > SPACE PLANNING PARAMETERS

- 2.12.1. IT Room locations are based on the American National Standards Institute/Telecommunications Industry Association (ANSI/TIA) horizontal cabling restrictions for Category 6/6A Unshielded Twisted Pair (UTP) copper.
- 2.12.2. CAT 6/6A is the cable of choice for local data transmission. Copper is plentiful and relatively inexpensive. However, in order to meet most network and application requirements for bandwidth and speed, small gauge copper is limited to a maximum distance of 328 feet (100 meters) per industry standard. This is called the Channel.
- 2.12.3. The cable distance restrictions must adhere to and translate into spacing restrictions between IT Rooms. Since all areas of a building need to be reachable by the cables from IT Rooms, the number of IT Rooms required is dependent upon the location within the building and the amount of coverage area required. The area served by an IT Room is called the circle of coverage.
- 2.12.4. The maximum distance of 328 ft. for the Channel includes 16 ft. 6 in. maximum allowance for jumper's length at each end. The cabling between the 2 jumpers is called the Permanent Link. The maximum distance for the Permanent Link is 295 ft.

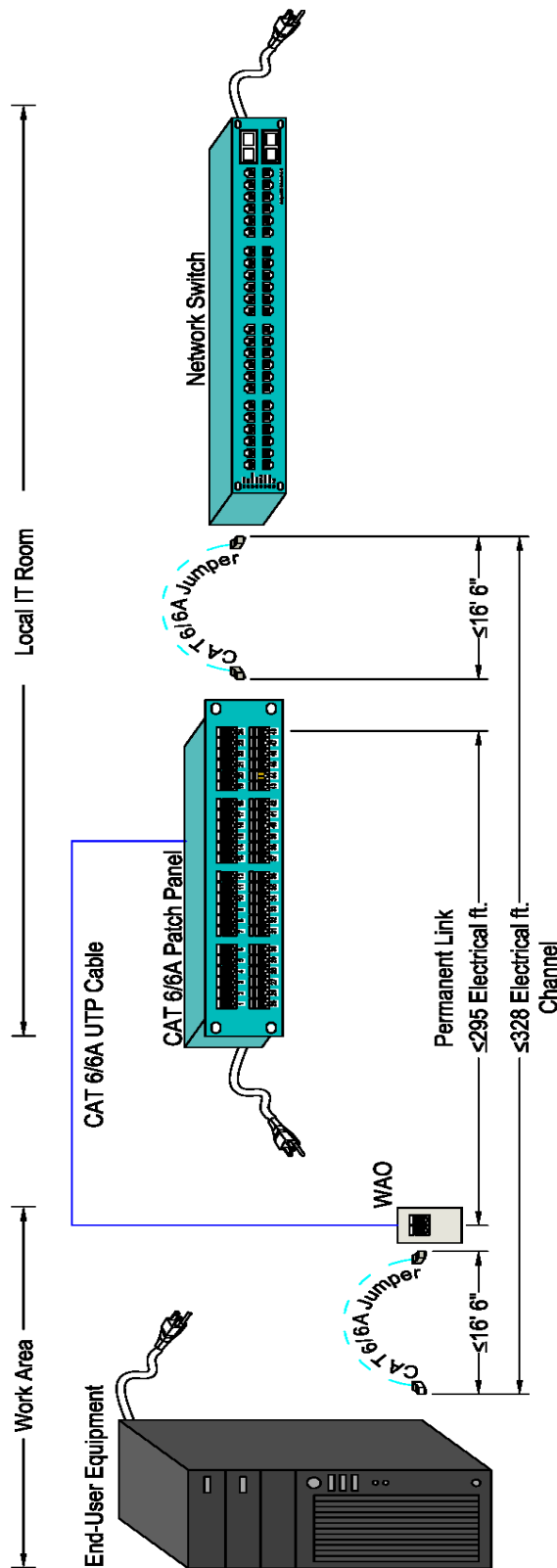

Difference between the channel and the permanent link.

Legend:

Work Area - Where the end-user works.

Work Area Outlet (WAO) - The termination point of the Horizontal Cable in the Work Area and the transition point for the equipment jumper that connects the end-user equipment to the horizontal cable.

Horizontal Cable - The cabling that connects the WAO to the copper patch panel in the IT Room.

Permanent Link- The combination of the WAO, the Horizontal Cable, and the patch panel - not to exceed 295 ft.

Patch Panel - The termination point for the Horizontal Cable in the IT Room and the transition point for the Equipment Jumper that connects to the network switch.

Equipment Jumpers - The copper patch cords that connect the WAO to the work area equipment on one end, and the copper patch panel to the network switch on the other end. Equipment jumper lengths are not to exceed 16 ft. 6 in.

The Channel- The combination of the Permanent Link plus the equipment jumpers at each end and shall not exceed 328 ft.

2.13. L&S > IT ROOMS > SPACE PLANNING

- 2.13.1. In most cases, a cable cannot run in a straight line from the IT Room to the work area outlet due to architectural restrictions and equipment obstructions. Therefore, the 295' is further decreased by 95' to account for cable routing through the IT Room and around obstructions in the ceiling on the way to the work area outlet. 95' from 295' leaves 200'. Therefore, LAWA uses 200 ft. circles of coverage.
- 2.13.2. IT Rooms per LAWA standards shall have a maximum circle of coverage with a radius of 200 feet from the designated IT Room to the WAO.

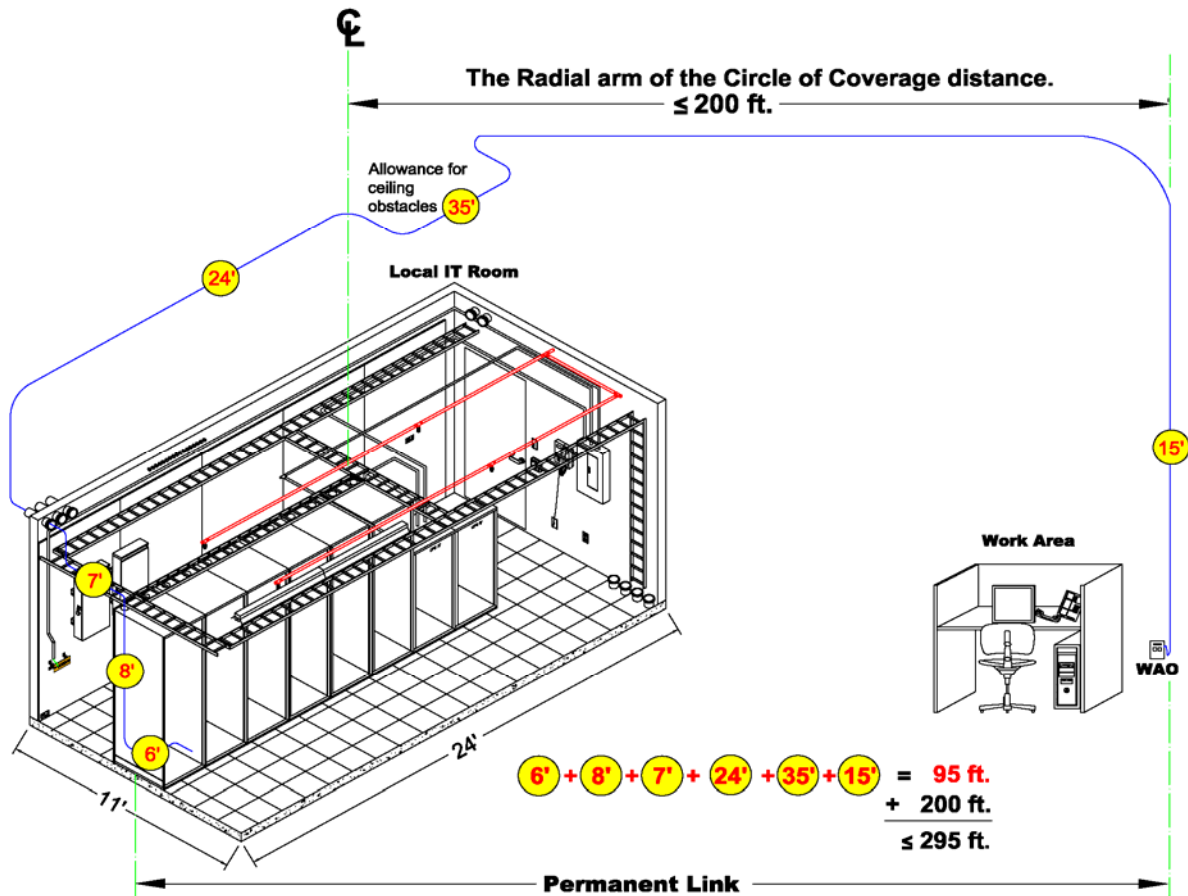

Single-story basis for the 200 ft. radius circle of coverage from the IT Room to work area outlets.

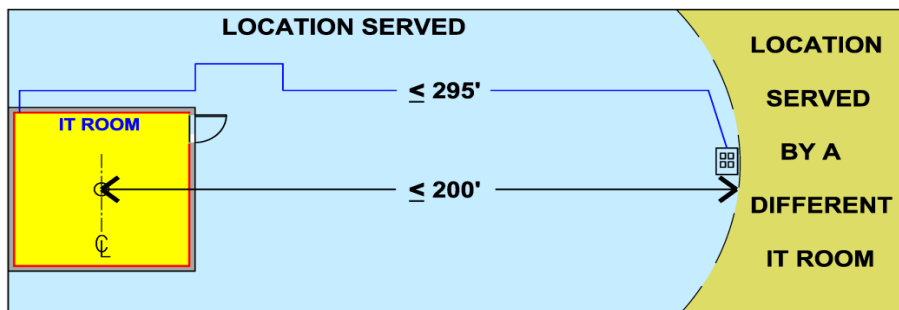

Areas outside of the 200' circle radius shall be fed from a different IT Room.

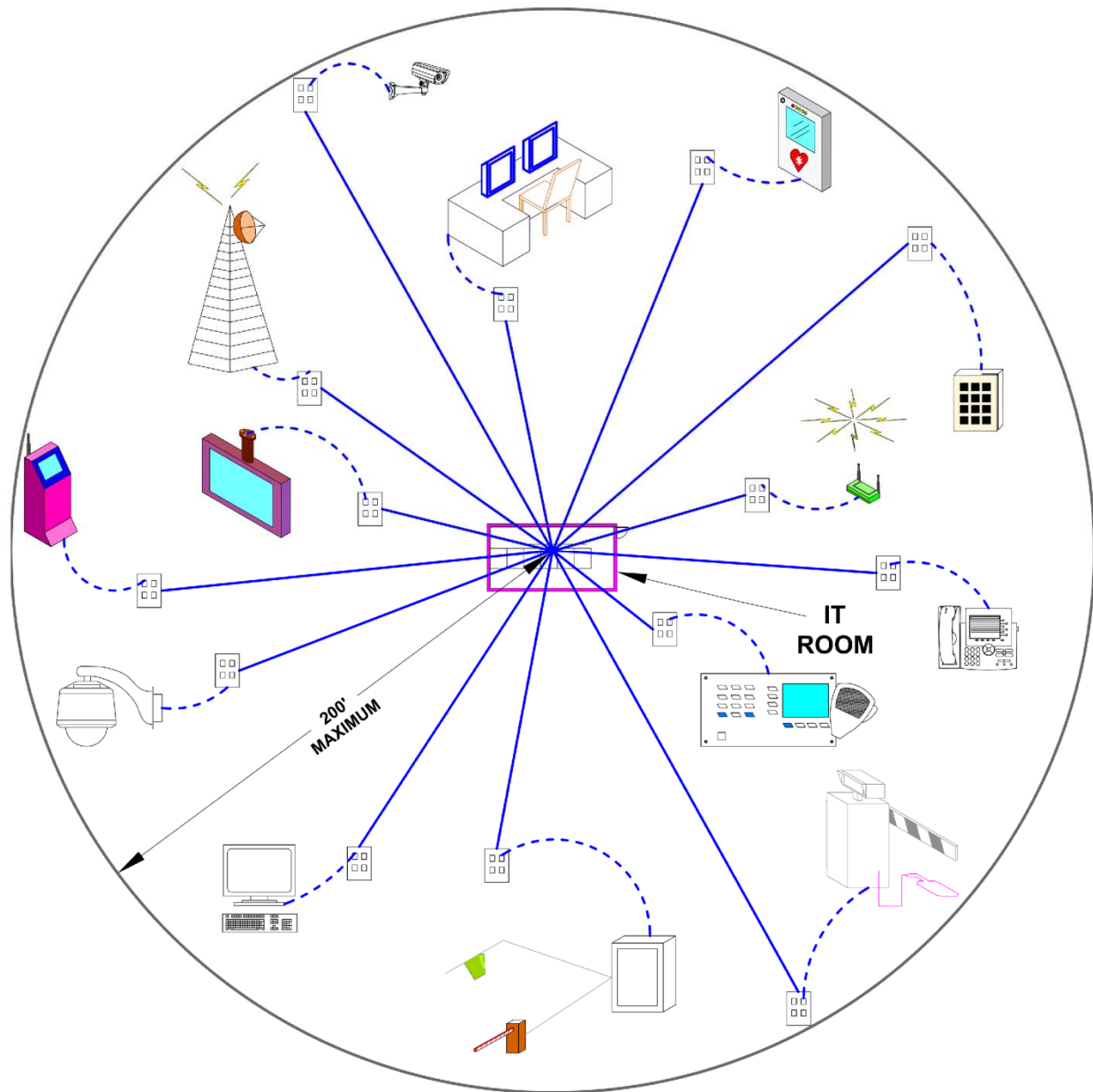

Field devices within the 200 ft. radius circle of coverage.

2.13.3. Areas outside of the 200' circle radius shall be fed from a different IT Room.

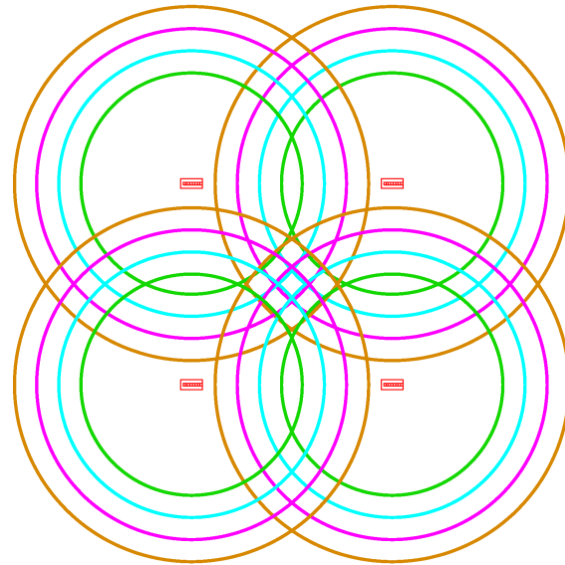
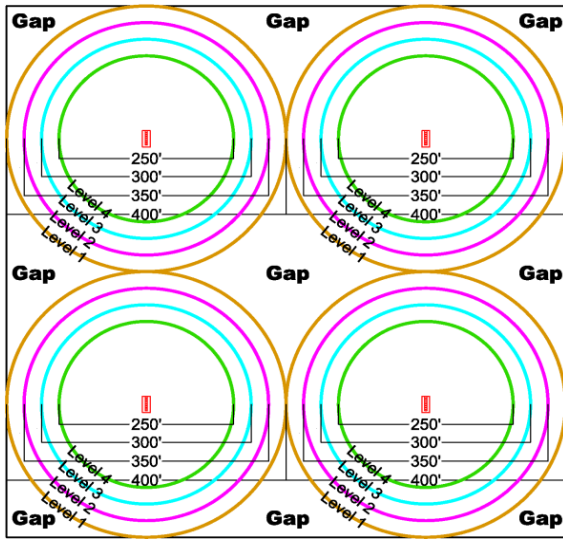

Gaps in coverage must be eliminated by bringing IT Rooms closer together and/or using Telecommunication Enclosures for fiber and network points-of-presence.

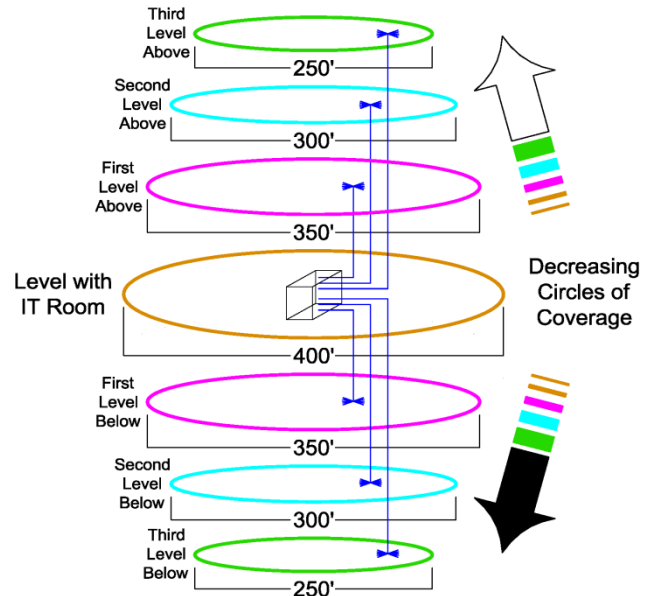
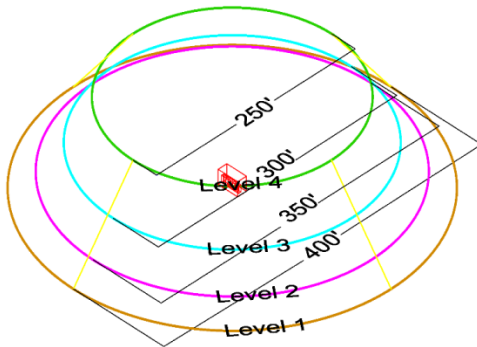

IT Room circles of coverage decrease in size the further away they get from the IT Room.

- 2.13.4. IT Room coverage-circles shall overlap sufficiently to cover all areas of the floor without gaps in coverage between and outside of the coverage circles.
- 2.13.5. Sufficient IT Rooms shall be constructed to cover the entire area (both horizontal and vertical) of the new facility - regardless of the facility's shape.
- 2.13.6. Multiple IT rooms that only serve the floor on which they are located shall be spaced not to exceed 400 linear feet between IT Rooms. Designers shall use 200 foot radius circles on the floor plans with the circle's center located in the center of the IT Room when determining IT Room placement.

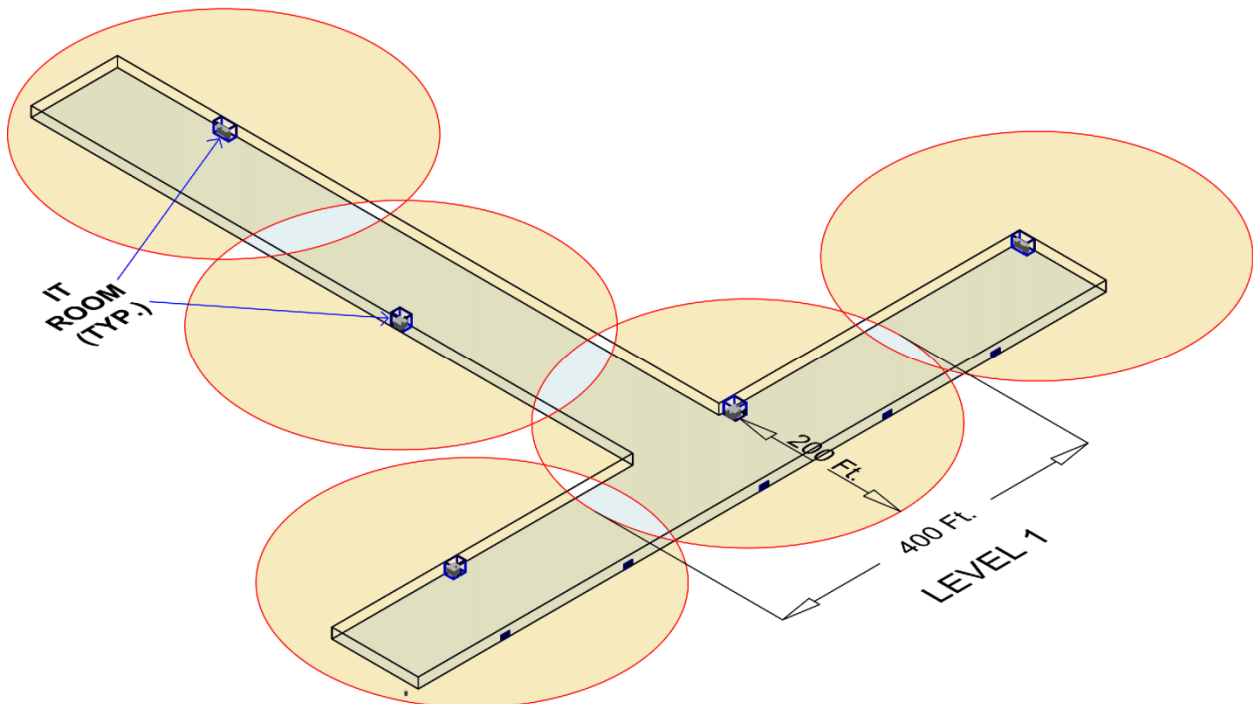

An acceptable number of IT Rooms for this single story facility.

2.14. L&S > IT ROOMS > LAYOUT

- 2.14.1. IT Rooms should be rectangular or square in shape (not triangular, circular, or rhombic) unless the room is large enough to meet all the requirements in this Standard.
- 2.14.2. IT Room shape can be laid out to have one row of continuous cabinets, one row of cabinets split in the middle to accommodate a center door, or two rows of cabinets.
- 2.14.3. Building columns that intrude into IT Room space shall be located in the corners of the room to minimize spacial disruption. If a column protruding from the wall cannot be in the corners, then the IT room shall be upsized to offset the protrusion.
- 2.14.4. Columns shall never be within the room proper. If it is not possible to have space for an IT Room without a column in the center of the room, then the IT room shall be upsized to offset the protrusion.



A standard rectangular IT Room Layout upsized due to unavoidable column interference.



A standard rectangular IT Room Layout with no columns.

2.15. L&S > IT ROOMS > DIMENSIONS

- 2.15.1. IT Rooms within passenger terminals shall have a minimum square footage of 230 unobstructed square feet. An IT Room that is proposed to be less than 230 sq. ft. will require a waiver approved by LAWA. This minimum 230 sq. ft. IT Room is for LAWA IT equipment use only and does not include space for backup power, air conditioning, fire protection, tenant or Service Providers equipment. This equipment should be located outside of the IT Room.
- 2.15.2. This minimum 230 sq. ft. IT Room shall have a minimum width of 11-feet and shall contain six (6) equipment cabinets. Equipment cabinets shall be sized at a minimum of 34" W x 36" D x 84" H. Access between the equipment cabinet doors and the perimeter wall or equipment shall be 4 ft. minimum.

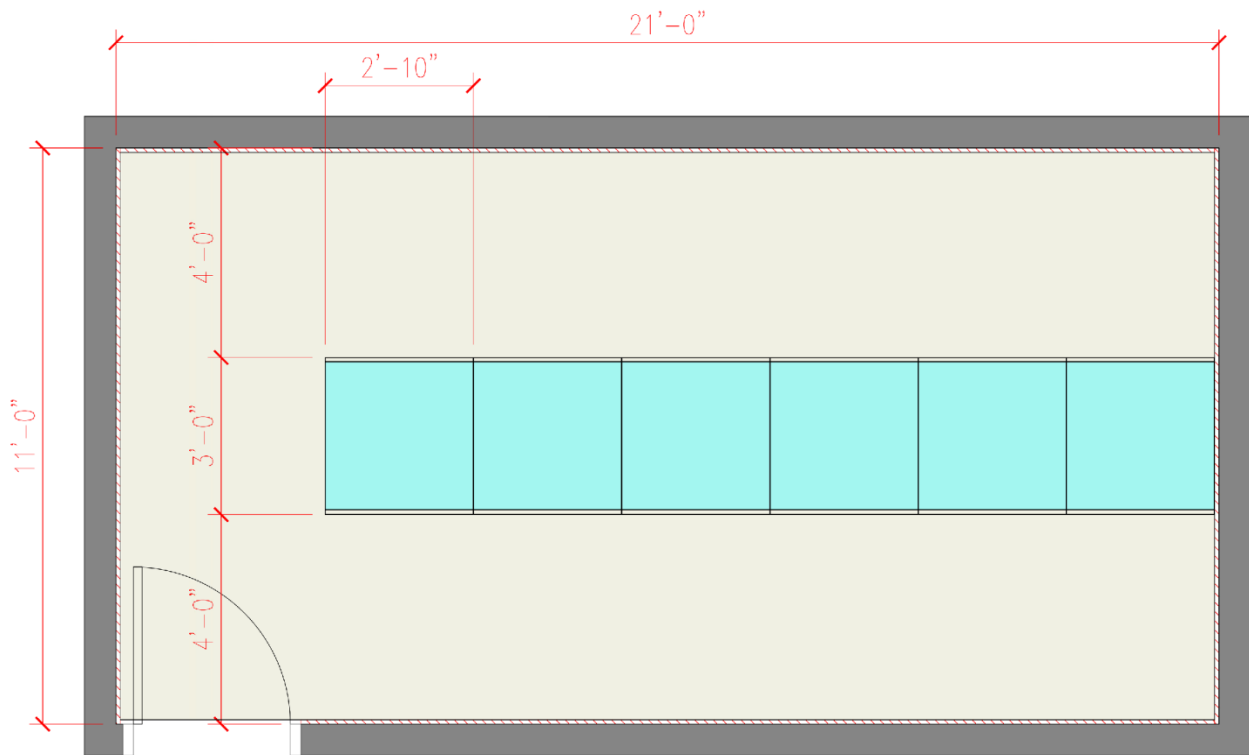

Minimum dimensions of a local IT Room in a passenger terminal with 6 cabinets and no utilities.

- 2.15.3. IT Rooms in LAWA office buildings shall have a minimum square footage of not less than 140 unobstructed square feet. An IT Room that is proposed to be less than 140 sq. ft. will require a waiver approved by LAWA. This 140 sq. ft. IT Room is for LAWA IT equipment use only and does not include space for backup power, air conditioning, fire protection, tenant or Service Providers equipment. This equipment should be located outside of the IT Room.
- 2.15.4. IT Rooms in LAWA office buildings shall contain three (3) equipment cabinets. Equipment cabinets shall be sized at a minimum of 34" W x 36" D x

84" H. Access between the equipment cabinet doors and the perimeter wall or equipment shall be 4 ft. minimum.

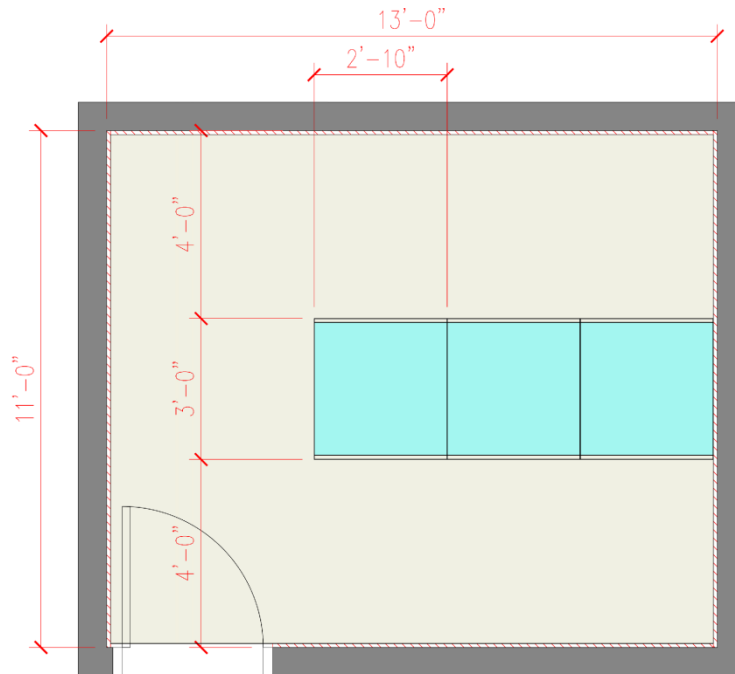

Minimum dimensions of a local IT Room in an office building with 3 cabinets and no utilities.

- 2.15.5. IT Rooms with architectural obstruction(s) must increase their unobstructed square footage to compensate for such obstruction(s).

2.16. L&S > IT ROOMS > PLANNING MULTI-STORY SPACES

- 2.16.1. In multi-story buildings, IT Rooms should be stacked on top of each other in-so-far as it is architecturally feasible to do so.

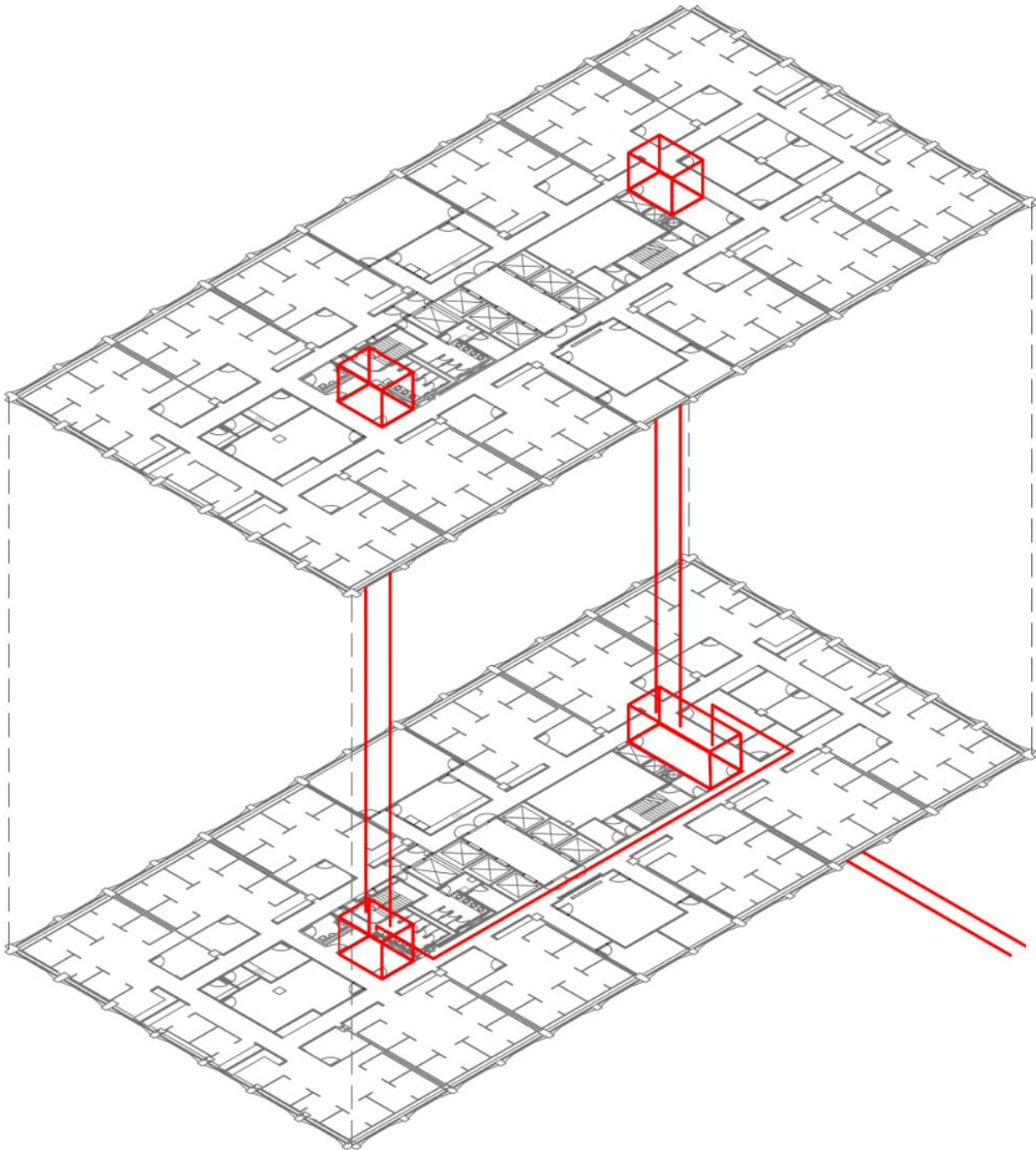

Example of stacking IT Rooms in a two-story building.

- 2.16.2. IT rooms that serve multiple floors in addition to the floor on which they are located shall have their circle of coverage decreased 25 radial feet for each single-story vertical rise or descent.

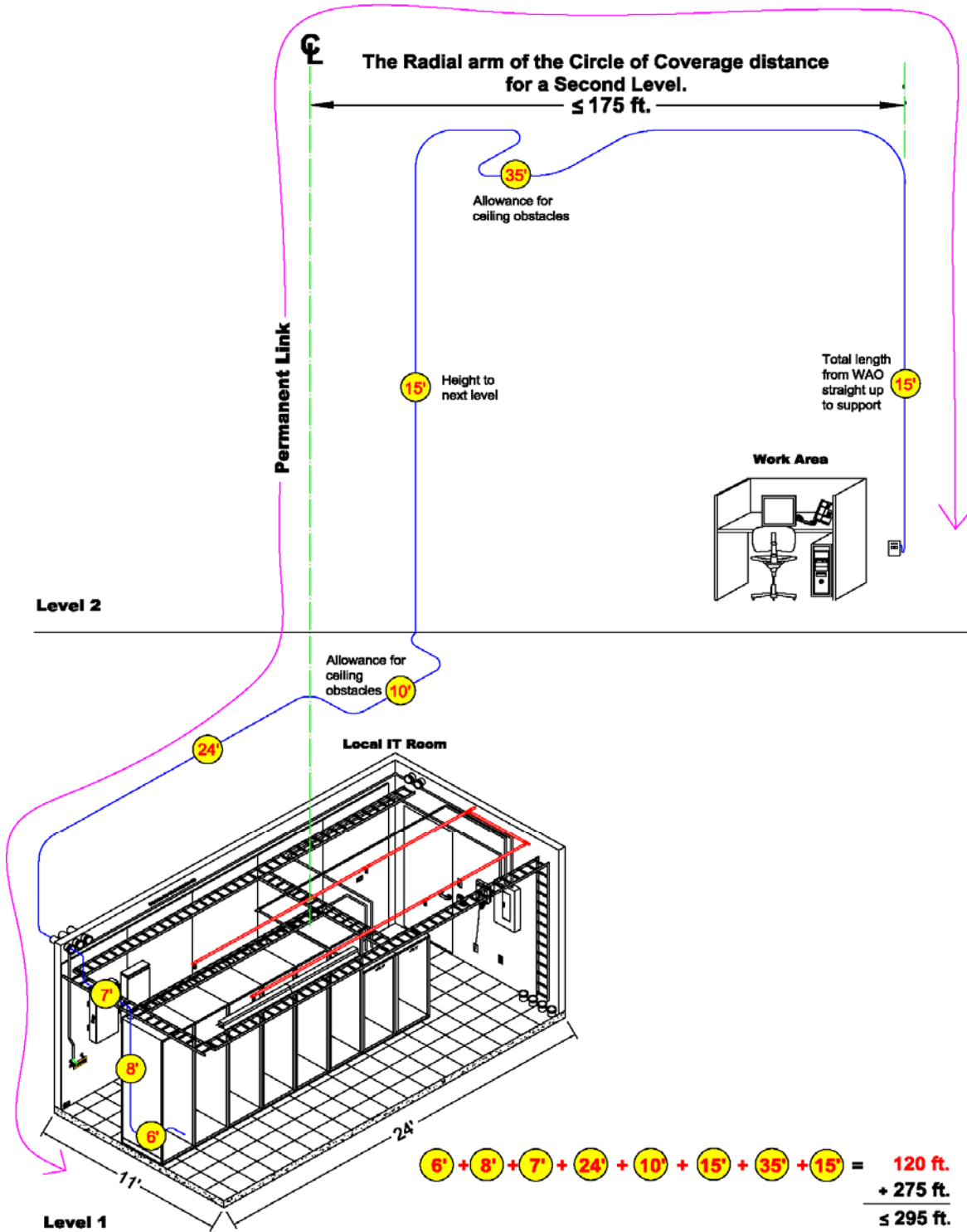

Multi-story circle of coverage decreases by 25 feet for each level served away from the IT Room.

- 2.16.3. Sufficient IT Rooms shall be constructed to cover the entire area (both horizontal and vertical) of the new facility - regardless of the facility's shape.
- 2.16.4. If an additional IT Room is impractical to cover a gap, such as when covering areas on the roof, then Telecommunications Enclosures approved by LAWA shall be installed to provide adequate coverage.

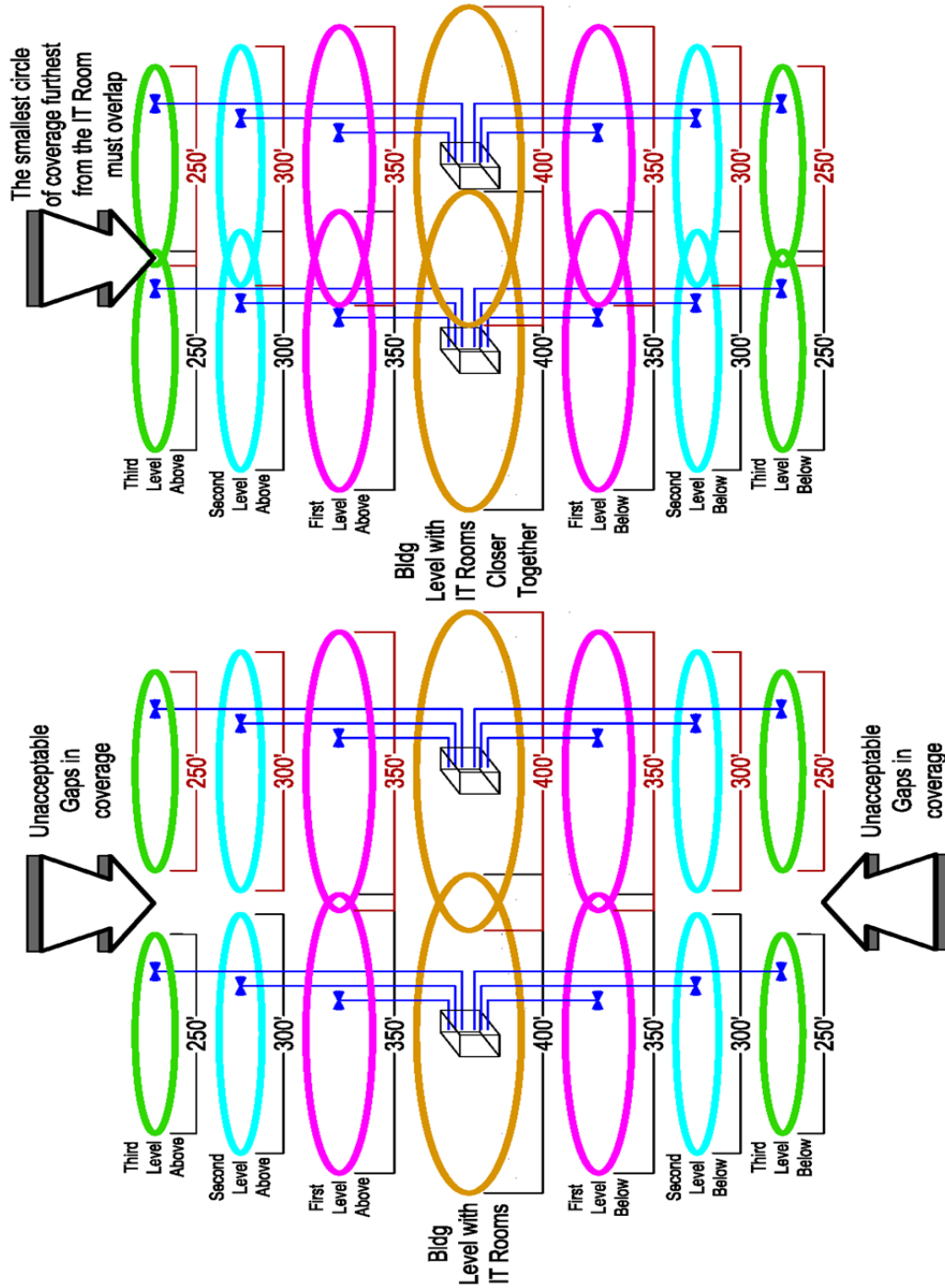

IT Rooms serving multiple levels must have circles of coverage that overlap - no gaps.

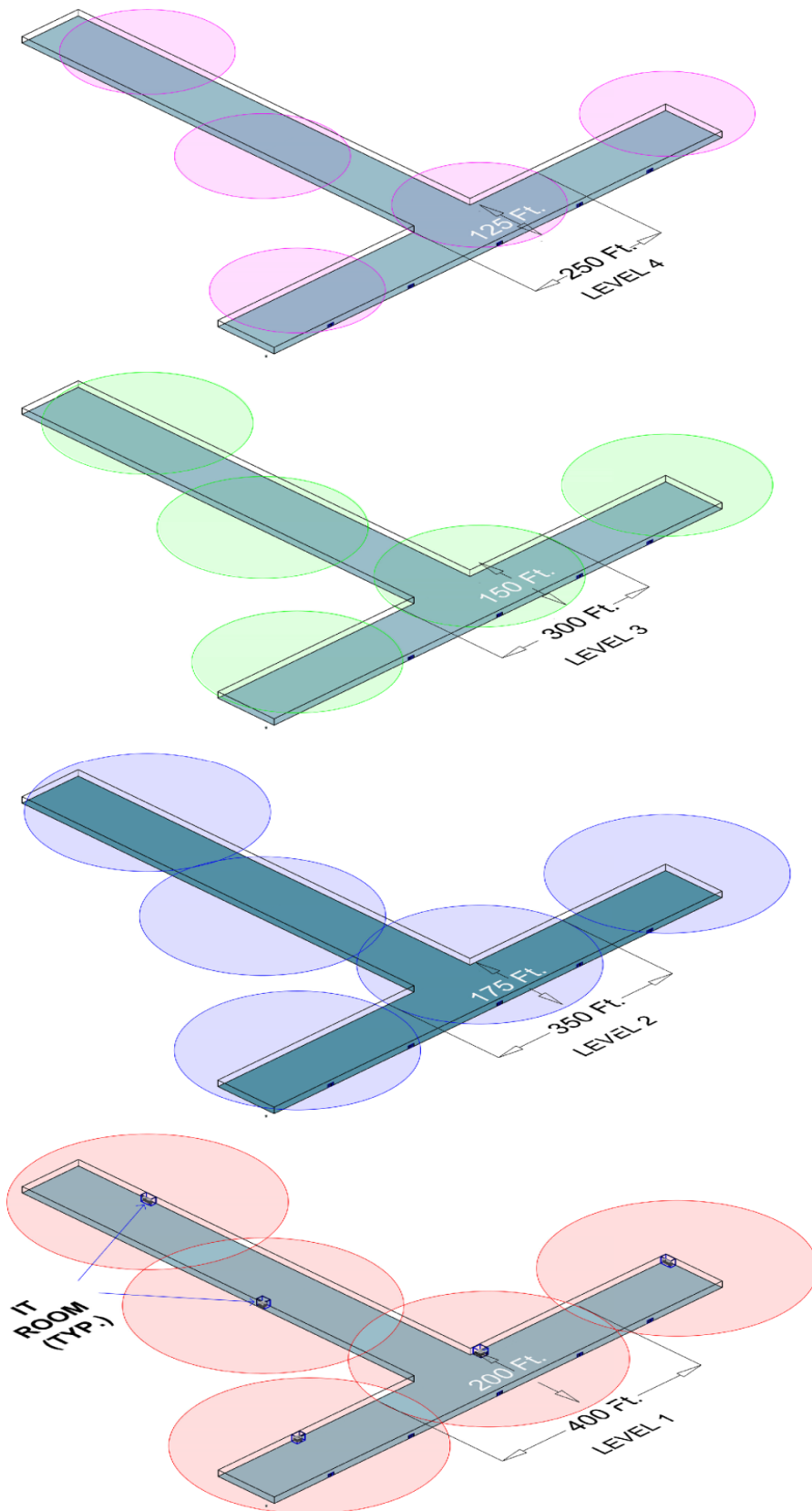

IT Room circles of coverage sufficient for level 1 but not levels 2, 3, 4, or the roof.

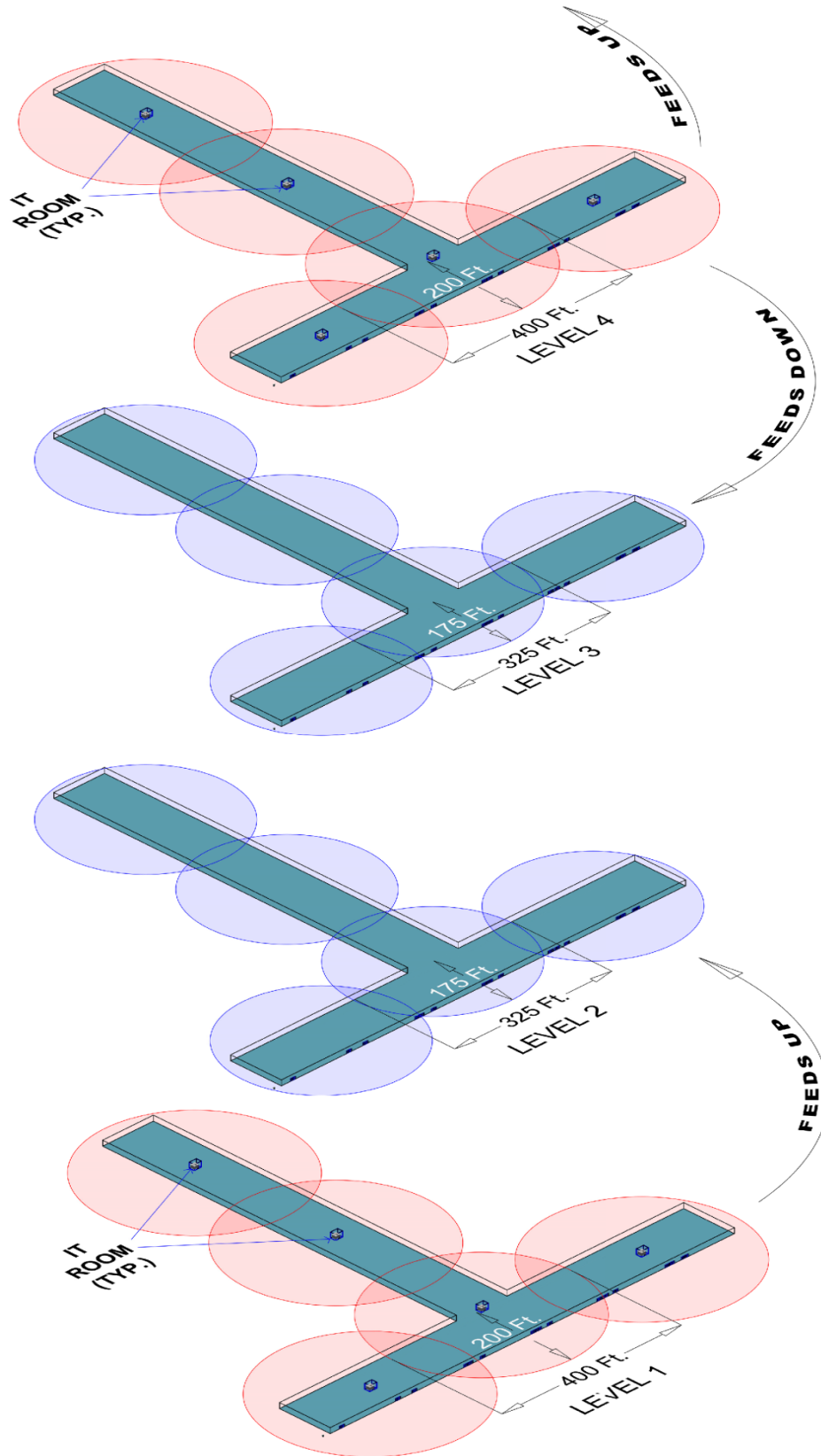

A sufficient number of IT Rooms is shown to provide coverage for 4 levels and the roof.

2.17. L&S > IT ROOMS > ELECTRICAL

- 2.17.1. All IT Rooms shall have their own 208V, 3 phase, 4-wire, dedicated electrical panels and dedicated UPS panels. Calculations for electrical service for IT Room equipment shall be based on a minimum average of 2.8 kW per cabinet or rack.
- 2.17.2. A sample MPOE electrical calculation with LAWA standards requirements is:
- 6 LAWA equipment cabinets at 2.8 kW each = 16.8 kW
 - 1 Service Provider racks at 2.8 kW each = 2.8 kW
 - 4 - Tenant Common-Use Wiring Closet ½-size cabinets with no loads

$$\text{Amps} = \frac{\text{kWatts} \times 1000}{\text{V} \times \text{Power Factor} \times 1.73}$$

$$\text{Amps} = \frac{19.6 \times 1000}{120 \times 0.86 \times 1.73} = \mathbf{109.8 \text{ A}}$$

- 2.17.3. All IT Room electrical panel grounding shall be bonded to the Telecommunications Grounding Busbar (TGB).
- 2.17.4. All IT Rooms with six (6) equipment cabinets shall have a minimum 150 Amp main circuit breaker (if not already de-rated to 80%) or a 125 Amp panel main breaker (if already de-rated 80% like Cutler-Hammer) - unless equipment loads require adjustment.

2.18. L&S > IT ROOMS > UPS > 208 VOLT SYSTEMS

- 2.18.1. Electrical – UPS, 208V Input (4 wire plus ground).
- 2.18.2. Calculations for Liebert UPS backup for IT Room equipment shall be based on a minimum average of 2.8 kW per cabinet or rack.



A 20 kVA Liebert UPS and battery cabinet shown.

- 2.18.3. Provide (1) 20kVA/16kW 120/208V-input, 3-phase UPS, model Liebert NX 38SB020C0CHX or most current equivalent Liebert model per calculated load. Include internal VRLA battery capacity rated to 18 minutes at full load w/ disconnect facility for maintenance. UPS shall be packaged in a single 24" wide cabinet with automatic continuous static transfer switch and internal manual bypass. Include seismic anchoring and (1) OC-485 Webcard to

interface w/ SiteLink system. Connect 120/208V output to single wall-mounted panelboard.



A 20kVA Liebert UPS shown with battery bank cabinet.

- 2.18.4. Provide (1) external VRLA battery cabinet providing for a total of (41) minutes at 16kW load, model Liebert 38BP020RHX1BNR or most current equivalent Liebert model. Include DC cables so that 27" battery cabinet can be directly bolted to right side of UPS cabinet. Include seismic anchoring.

- 2.18.5. Provide (1) external maintenance bypass cabinet, model Liebert 38MB0200CC6AL or most current equivalent Liebert model. Include interconnecting cables for bolting to left side of UPS. Cabinet shall be 27" wide with single rotary switch interlocked for make-before-break manual transfers. Include seismic anchoring.



Maintenance Bypass for UPS shown.

2.19. L&S > IT ROOMS > UPS > 480 VOLT SYSTEMS

- 2.19.1. Electrical – UPS, 480V Input (3 wire plus ground)
- 2.19.2. Calculations for Liebert UPS backup for IT Room equipment shall be based on a minimum average of 2.8 kW per cabinet or rack.



Close-up of a 20kVA Liebert UPS for a standard 6-cabinet IT Room.

- 2.19.3. Provide (1) 20kVA/16kW 480V-input, 120/208v output, 3-phase UPS. Model Liebert NX 38SB020C0CHX or most current equivalent Liebert model per calculated load. Include internal VRLA battery capacity rated to 18 minutes at full load w/ disconnect facility for maintenance. UPS shall be packaged in a single 24" wide cabinet with automatic continuous static transfer switch and internal manual bypass. Include (1) OC-485 Webcard to interface w/ SiteLink system. Include (1) external maintenance bypass/transformer cabinet, model Liebert 38MB0200AC6DL or most current equivalent Liebert model. Include interconnecting cables for bolting to left side of UPS. Cabinet shall be 27" wide with 480V input isolation transformer and single rotary switch interlocked for make-before-break manual transfers. Include seismic anchoring for both cabinets. Connect 120/208V UPS output to single wall- mounted panelboard.
- 2.19.4. Provide (1) external VRLA battery cabinet providing for a total of (41) minutes at 16kW load, model Liebert 38BP020RHX1BNR or most current equivalent Liebert model. Include DC cables so that 27" battery cabinet can be directly bolted to right side of UPS cabinet. Include seismic anchoring.

- 2.19.5. Provide (1) external maintenance bypass cabinet, model Liebert 38MB0200CC6AL or most current equivalent Liebert model. Include interconnecting cables for bolting to left side of UPS. Cabinet shall be 27" wide with single rotary switch interlocked for make-before-break manual transfers. Include seismic anchoring.

2.20. L&S > IT ROOMS > UPS > SMALLER IT ROOMS GENERAL

- 2.20.1. Smaller IT Room UPS's shall be sized for the maximum IT Room load plus 30%.
- 2.20.2. Smaller IT Room UPS's shall be installed in the electrical room or a room separate from but adjacent to the MPOE Room.
- 2.20.3. Smaller IT Room UPS's shall be backed up by the facility generator through an external Automatic Transfer Switch (ATS) that is installed in a room separate from the MPOE Room.
- 2.20.4. Smaller IT Room UPS's shall be provided with a Liebert SiteLink system allowing for communication with UPS's and Mechanical system components for integration with SITESCAN Web software via TCP/IP.

2.21. L&S > IT ROOMS > UPS > WITHIN EQUIPMENT CABINETS

- 2.21.1. Equipment cabinets that require smaller UPS's to support a network switch or other specialized equipment shall use Schneider Electric American Power Conversion (APC) Smart UPS rack-mount units.
- 2.21.2. Battery packs to be added in accordance with run time requirements. See the IT Systems Chapter for specific run-time requirements.
- 2.21.3. All UPS's shall be rack-mounted. There shall be no tower-type UPS's on the floor or on cabinet shelves.
- 2.21.4. All UPS's shall have dedicated electrical circuits.
- 2.21.5. Rack-mount UPS's shall have a network interface card (NIC) connected to the LAWA-designated network switch.
- 2.21.6. Rack-mounted UPS's shall be fitted with twist-lock plugs to facilitate maintenance and battery changes.
- 2.21.7. Rack-mounted UPS's shall not exceed 5,000 kVA in size.
- 2.21.8. Rack-mounted UPS's shall have an Automatic Transfer Switch (ATS) installed unless the UPS has a built-in dual power source capability.

2.22. L&S > IT ROOMS > HVAC

2.22.1. All LAWA IT Rooms shall have primary chilled water air conditioning units and backup air-cooled air conditioning units; each unit provided with leak detection. HVAC calculations shall be based on a minimum 2.8 kW per equipment cabinet or rack.

2.22.2. IT Room calculations are derived as follows: IT Room (not data center) cabinet electrical usage was measured using a data logger in different locations with amp clamps at between 1.8 kW and 2.3 kW per cabinet. These numbers were averaged together and an additional allowance of 35% was added for future growth. 2.8 kW per cabinet was determined to be a baseline value for future growth.

2.22.3. IT Room HVAC requirements are calculated as follows:

- 6 LAWA cabinets x 2.8kW = 16.8 kW
- Service Provider racks are not included
- 4 tenant cabinets with no active equipment

Heating

- 1 Watt electrical consumption = 3.41 BTU/hr.
- 16.8 kW x 3.41 = 57,288 BTU/hr. heating

Cooling

- 1 Ton of refrigeration = 12,000 BTU/hr. cooling
- 57,288 / 12,000 = 4.77 ton cooling
- 4.77 ton is rounded up to 5 ton.

2.22.4. IT Rooms shall have Liebert PCW PW017 chilled water 5 ton units or most current equivalent Liebert model as the primary system, and Liebert PDX PX018 direct expansion 5 ton units or most current equivalent Liebert model as the backup system for air conditioning unless calculated loads determine that a larger Liebert PW029, PX023 or PX029 unit is required.

2.22.5. If Service Provider equipment is included, then increase air conditioning by 1 ton and use the larger Liebert PW029 or most current equivalent Liebert model as the primary system, and Liebert PX023 unit or most current equivalent Liebert model as the backup.

2.22.6. Chilled water pipes shall be kept to a minimum, follow and remain within twelve inches of perimeter walls for their pathways until connecting to equipment. Chilled water pipes shall not be installed above equipment or equipment cabinets. Back-up units shall not have chilled water. The back-up unit shall have a 3-year preventative warranty purchased with the unit.

2.22.7. Final acceptance and commissioning requirements for MPOE HVAC shall include testing of:

- System and air balance
- Interface with the Building Automation System (BAS)
- Interface with the Fire Life Safety System (FLSS)
- HVAC and IT monitoring system

2.22.8. All testing shall be performed by the manufacturer's representative(s).

2.23. L&S > SERVICE PROVIDERS > SPACE PLANNING

- 2.23.1. All passenger terminals shall have dedicated space for Service Provider (SP) entrance facilities that is not within the MPOE but adjacent to it.
- 2.23.2. SP entrance facilities within passenger terminals shall have a dedicated square footage of not less than 300 unobstructed square feet without LAWA's prior approval. This 300 sq. ft. is for SP equipment racks, equipment and cabling use only and does not include space for backup power, air conditioning, and fire protection equipment. This equipment should be located outside of the IT Room.
- 2.23.3. SP entrance facilities within passenger terminals shall contain space for three (3) equipment racks. Equipment racks shall be sized at a minimum clearance of 34" W x 36" D x 84" H.
- 2.23.4. All LAWA office buildings shall have SP entrance facilities.
- 2.23.5. SP entrance facilities in LAWA office buildings shall have a square footage of not less than 140 unobstructed square feet without LAWA's prior approval. This 140 sq. ft. is for SP equipment racks, equipment and cabling use only and does not include space for backup power, air conditioning, and fire protection equipment. This equipment should be located outside of the IT Room.
- 2.23.6. SP entrance facility conduits shall be a minimum of two (2) 4-inch. One of the 4-inch conduits shall contain three, 3-cell, MaxCell fabric innerducts.
- 2.23.7. Entrance facility conduit and cable bend radii shall not be less than 24-inches for backbone fiber and copper cable with 200 pairs. The bend radius shall be increased to 48-inches for 300-pair cables. Beyond 300 pairs, Service Providers shall be contacted for their requirements. These requirements exceed industry standards.
- 2.23.8. All SP copper cables that enter buildings from outside shall have protector blocks in accordance with AT&T standards.
- 2.23.9. SP entrance facility rooms shall be built-out similar to an IT Room, with anti-static floor, painted plywood backboards, ladder rack, etc.
- 2.23.10. SP entrance facility rooms shall also have a Telecommunications Grounding Busbar (TGB) that is tied to the MPOE's TMGB and building steel.

- 2.23.11. SP entrance facility rooms shall have sufficient space for a minimum of three (3) SP racks in accordance with the dimensions specified in Common elements > Cabinets section.

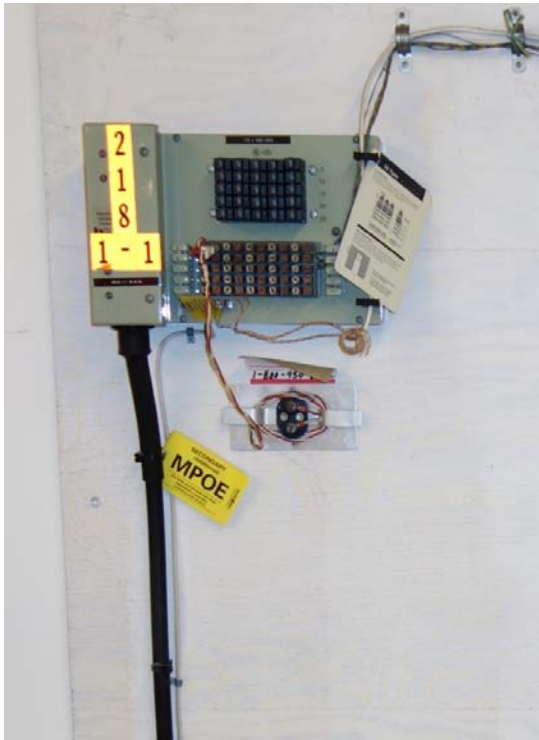

Small Copper Entrance Facility.



Mid-sized Copper Entrance Facility.



Large Entrance Facility with Service Provider-terminated cable protectors.

2.24. L&S > SERVICE PROVIDERS > ELECTRICAL

- 2.24.1. All Service Providers shall be contacted for their electrical requirements.
- 2.24.2. All Service Providers shall have redundant electrical feeds for maintenance.
- 2.24.3. Service Provider Entrance Facilities shall connect to the LAWA MPOE electrical panel if SP is adjacent to MPOE. If SP entrance Facility is not adjacent to the MPOE, the MPOE Electrical Section shall be followed.
- 2.24.4. If connection to the LAWA MPOE electrical panel is not feasible, then the Service Provider Entrance Facility shall have a dedicated electrical panel.
- 2.24.5. If SP electrical requirements are unavailable, the following can be used. Three (3) SP equipment cabinets shall have a minimum 60 Amp main circuit breaker (if not already de-rated to 80%) or a 50 Amp panel main breaker (if already de-rated 80% like Cutler-Hammer) - unless equipment loads require adjustment.
- 2.24.6. A sample SP electrical calculation if SP requirements are not available is:

- 3 Service Provider racks at 2.8 kW each = 8.4 kW

$$\text{Amps} = \frac{\text{kWatts} \times 1000}{\text{V} \times \text{Power Factor} \times 1.73}$$

$$\text{Amps} = \frac{8.4 \times 1000}{120 \times 0.86 \times 1.73} = \mathbf{47.1 \text{ A}}$$

- 2.24.7. All Service Provider electrical panel grounding shall be bonded to the Telecommunications Main Grounding Busbar (TMGB).
- 2.24.8. Contact SP's for electrical outlet requirements.

2.25. L&S > SERVICE PROVIDERS > HVAC

2.25.1. In lieu of Service Provider-provided HVAC requirements, SP HVAC calculations are derived as follows: IT Room (not data centers) cabinet electrical usage was measured in different locations with amp clamps at between 1.8 kW and 2.3 kW per cabinet. These numbers were averaged together and an additional 35% for future growth was added. 2.8 kW per cabinet was determined to be a reasonable number going into the future.

2.25.2. Service Provider HVAC requirements are calculated as follows:

- 3 LAWA cabinets x 2.8kW = 8.4 kW
- Service Provider racks are not included
- 4 tenant cabinets with no active equipment

Heating

1 Watt electrical consumption = 3.41 BTU/hr.

8.4 kW x 3.41 = 28,644 BTU/hr. heating

Cooling

1 Ton of refrigeration = 12,000 BTU/hr. cooling

28,644 / 12,000 = 2.39 ton cooling

2.39 ton is rounded up to 3 ton.

2.25.3. Service Provider Entrance Facilities shall have 3 ton for air conditioning with leak detection unless calculated loads determine that more is required.

2.25.4. If Service Provider equipment is required in/near IT Rooms, then increase the IT Room air conditioning requirement by 1 ton.

2.25.5. Chilled water pipes shall be kept to a minimum, follow and remain within twelve inches of perimeter walls for their pathways until connecting to equipment. Chilled water pipes shall not be installed above equipment or equipment cabinets.

2.25.6. Final acceptance and commissioning requirements for MPOE HVAC shall include testing of:

- System and air balance
- Interface with the Building Automation System (BAS)
- Interface with the Fire Life Safety System (FLSS)
- HVAC system
- IT monitoring system.

2.25.7. All testing shall be performed by the manufacturer's representative(s).

2.26. L&S > TENANT COMMON-USE WIRING CLOSETS

2.26.1. IT Rooms in passenger terminals shall have Tenant Common-Use Wiring Closets (TCWC) physically adjacent to them.

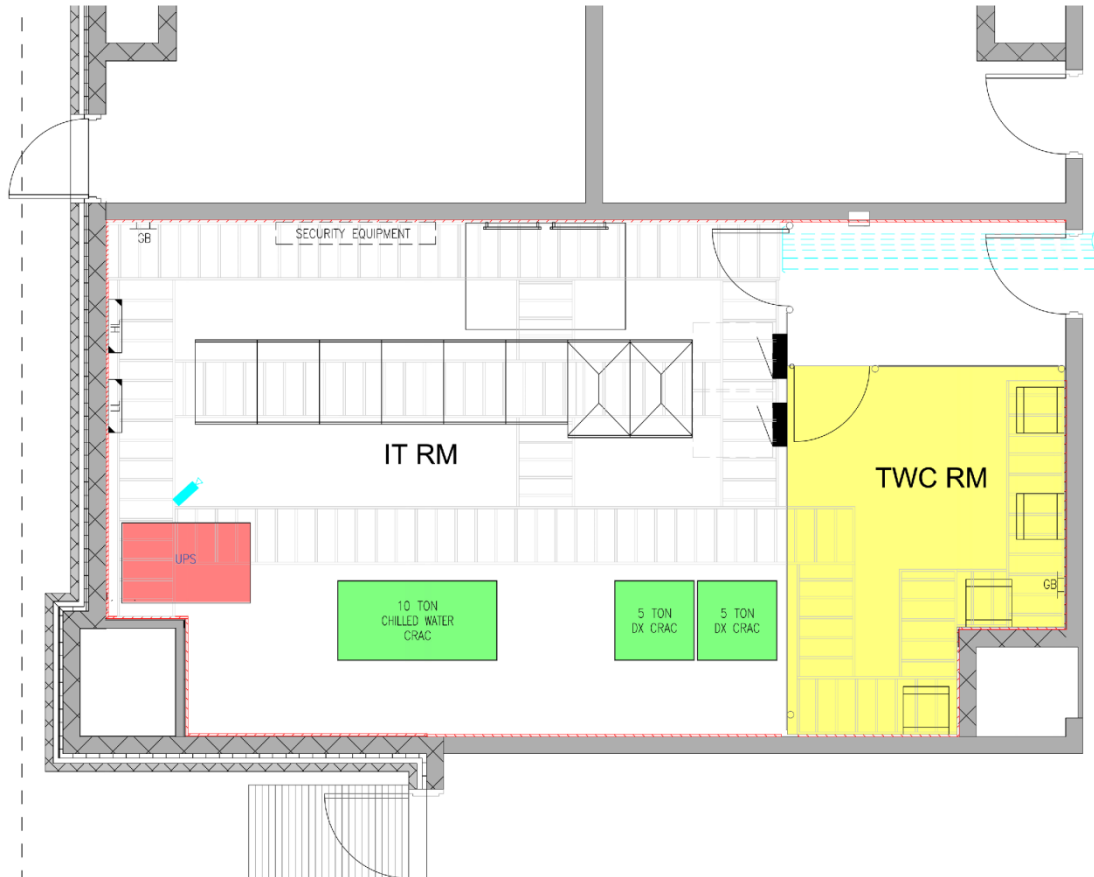

Tenant Common-Use Wiring Closet (TCWC) adjacent to IT Room through common entry vestibule.

2.26.2. TCWC's shall be constructed similarly to IT Rooms.

2.26.3. TCWC's should be sized at a minimum of 6' x 8'.

2.26.4. There shall be a divider between the LAWA side, the Service Provider side, and the Tenant side (if applicable). Preferably, the dividers are walls, but plastic-coated chain link is acceptable.

2.26.5. A minimum equivalent of two (2) 4-inch conduits or conduit sleeves or cable tray shall be installed from the TCWC room to the LAWA IT Room.

2.26.6. Tenants are responsible to extend infrastructure from the tenant leasehold to the TCWC – if a LAWA project does not do so already.

2.26.7. TCWC's shall have keyed cylinders and not ACAMS controlled access. See LAWA for the required key.



A TCWC as seen through chain link cage.



A Telecommunications Grounding busbar is required for TCWC's.

2.27. L&S > TELECOMMUNICATIONS ENCLOSURES > INDOOR

- 2.27.1. Installation of all Telecommunication Enclosures (TE's) require prior approval from LAWA IMTG.
- 2.27.2. Indoor TE's are enclosed spaces in which equipment is installed and to which pathways are connected. Indoor TE's include junction boxes, Armaracs, and other enclosures. Junction boxes are distinguished from pull boxes in that pull boxes contain cable only and not equipment.
- 2.27.3. Indoor wall-mounted Telecommunications Enclosures (TE) may be used to provide fiber optic and network points-of-presence for areas (gaps) not covered by local IT Rooms due to exceeding the 100m rule.
- 2.27.4. Indoor TE's with active equipment shall adhere to the same 200 ft. circle of coverage rules as IT Rooms.
- 2.27.5. Indoor TE's with active equipment shall use fan cooling unless load calculations determine that an integral air conditioning unit is required. Otherwise, air conditioning units for TE's are to be avoided.
- 2.27.6. All indoor TE's shall be UL listed and stamped.
- 2.27.7. All indoor TE's shall be large enough to contain the required CAT 6/6A terminations, CAT6/6A patch panel, fiber patch panel, network switch, and UPS to provide a minimum of 2 hours of run-time, etc. in accordance with LAWA standards.
- 2.27.8. All indoor TE's shall be large enough for the designed function plus 50% future growth capacity.
- 2.27.9. All indoor TE's shall have a means to mount equipment. This may be a steel backboard, a 3/4-inch plywood backboard, or vertical/horizontal racks and rails designed for the purpose.
- 2.27.10. Outdoor TE's shall be vented and screened near the top and near the base for convection cooling. TE's shall have integrated air conditioning only if absolutely necessary.
- 2.27.11. All indoor TE's shall be labeled on the outside and the inside in accordance with LAWA standards. See the Labeling Section for details.
- 2.27.12. TE's mounted indoors shall be steel or aluminum but not plastic or a plastic composite.
- 2.27.13. TE's shall have a minimum of one dedicated 120V 20 Amp circuit.
- 2.27.14. TE's shall have a quad electrical outlet installed.
- 2.27.15. TE's shall have an equipment grounding busbar installed.
- 2.27.16. Armarac-type TE's shall be keyed to LAWA's 751 cabinet key.
- 2.27.17. Junction boxes used for TE's shall have a hasp for locking with a padlock.

2.27.18. TE color selection shall require prior approval from LAWA.



A white-colored UL-Listed Armarac TE wall-mount enclosure outside view shown.



Armarac TE inside view showing swing-out panels for vertically-mounted equipment.

2.28. L&S > TELECOMMUNICATIONS ENCLOSURES > OUTDOOR

- 2.28.1. Outdoor TE's include junction boxes, pedestals, and other enclosures.
- 2.28.2. Outdoor TE's with active equipment shall adhere to the same 200 ft. circle of coverage rules as IT Rooms.
- 2.28.3. Outdoor TE's used for airport perimeter fiber optic coverage shall be spaced at less than 1,320 ft. (1/4 mile) apart.
- 2.28.4. Outdoor TE's shall be NEMA 4X stainless steel.



Rust is the reason for requiring outdoor TE's to be stainless steel.

- 2.28.5. All outdoor TE's shall be UL listed and stamped.



All TE's shall be UL listed and stamped.

- 2.28.6. All outdoor TE's shall have a plinth base or legs to separate the TE's from ground moisture.



TE's shall be raise up on legs or a plinth base.

- 2.28.7. All outdoor TE's shall be large enough to contain the required CAT 6/6A terminations, CAT6/6A patch panel, fiber patch panel, network switch, electrical, and UPS to provide a minimum of 2 hours of run-time, etc.
- 2.28.8. All outdoor TE's shall be large enough for the designed function plus 50% future growth capacity. Hoffman-type enclosures sized at 72" x 72" x 18" are typical in accordance with LAWA standards.

- 2.28.9. Outdoor upright-standing TE's shall be protected on all four sides. Protection can be provided by painted bollards or a combination of bollards and a building or fence/wall.
- 2.28.10. All outdoor TE's shall have a means to mount equipment. This may be a steel backboard, a ¾-inch plywood backboard, or vertical/horizontal racks and rails designed for the purpose.



A manufacturer-provided steel backboard drilled and tapped to mount the equipment.



A legacy outdoor TE with plywood backboard - prior to the stainless steel requirements.

- 2.28.11. All outdoor TE's shall be labeled on the outside and the inside in accordance with LAWA standards. See the Labeling Section for details.



A legacy outdoor TE with appropriate labeling. Rust is the reason for switching to Stainless Steel.

- 2.28.12. Outdoor TE's may be used to provide fiber optic and/or network points-of-presence for field equipment.

- 2.28.13. Outdoor TE's used for permanent installations shall be stainless steel and NEMA 4X-rated.
- 2.28.14. Outdoor upright-standing TE's shall be mounted to a concrete pad using a minimum, of four ½-inch x 4-inch stainless steel bolts, washers, and drop-in anchors. Concrete shall extend a minimum of 6-inches beyond the mounting bolts to minimize cracking. TE's shall not be mounted to asphalt unless for temporary use.
- 2.28.15. All TE's shall have a minimum of one dedicated 120V 20 Amp circuit.
- 2.28.16. All TE's shall have a quad Ground Fault Circuit Interrupter (GFCI) electrical outlet installed.
- 2.28.17. All TE's shall have an equipment grounding busbar installed.
- 2.28.18. All TE's shall have a hasp for locking with a padlock.
- 2.28.19. All TE's shall have hinged covers.
- 2.28.20. TE's shall have Galvanized Rigid Conduit (GRC) installed when conduits transition from underground to TE.



Stainless steel TE mounted on a concrete pad protected by bollards.

- 2.28.21. Outdoor TE's shall be vented and screened near the top and near the base for convection cooling. TE's shall have integrated air conditioning only if absolutely necessary.



An outdoor TE with top and bottom vents on both enclosure sides.



Outdoor TE's with vents for ambient air cooling.

- 2.28.22. Outdoor TE's used for temporary applications less than 12 months (like equipment and cable cutovers or providing temporary facilities) shall be steel, gray, powder-coated paint and have a NEMA 4X-rating.



Steel NEMA 4 TE's are permitted for temporary jobs up to 12-months duration.

- 2.28.23. Outdoor pole-mounted TE's shall be mounted at a height determined by LAWA. This height varies according to TE function and location - a parking lot will have a different height than a parking structure.
- 2.28.24. Outdoor TE's shall have a minimum equivalent of one 4-inch conduit for backbone pathway and additional conduits for everything else.



Legacy TE showing two 4-inch conduits on the left plus additional conduits on the right.



TE showing entrance and exit conduits.

2.29. L&S > HAND HOLES

- 2.29.1. Communication Hand Holes (HH's) are used in locations where it is not feasible to install larger Maintenance Holes (manholes) due to underground utility congestion. These are also used where a pathway of not more than 4 entry and 4 exit conduits without splice cases is needed. Pathways requiring splice cases and/or more than 4 entry and 4 exit conduits shall use Maintenance Holes (MH).
- 2.29.2. Hand Holes shall be poured (cast) concrete and have the following requirements:
- A minimum size of 36" W x 60" L x 48" H
 - Cable mounting racks rated for a minimum of 400 lbs. weight
 - Cable pulling eyes
 - Drain/sump hole
 - Two split covers
 - Torsion spring assisted covers
 - "COMM" welded on the top cover

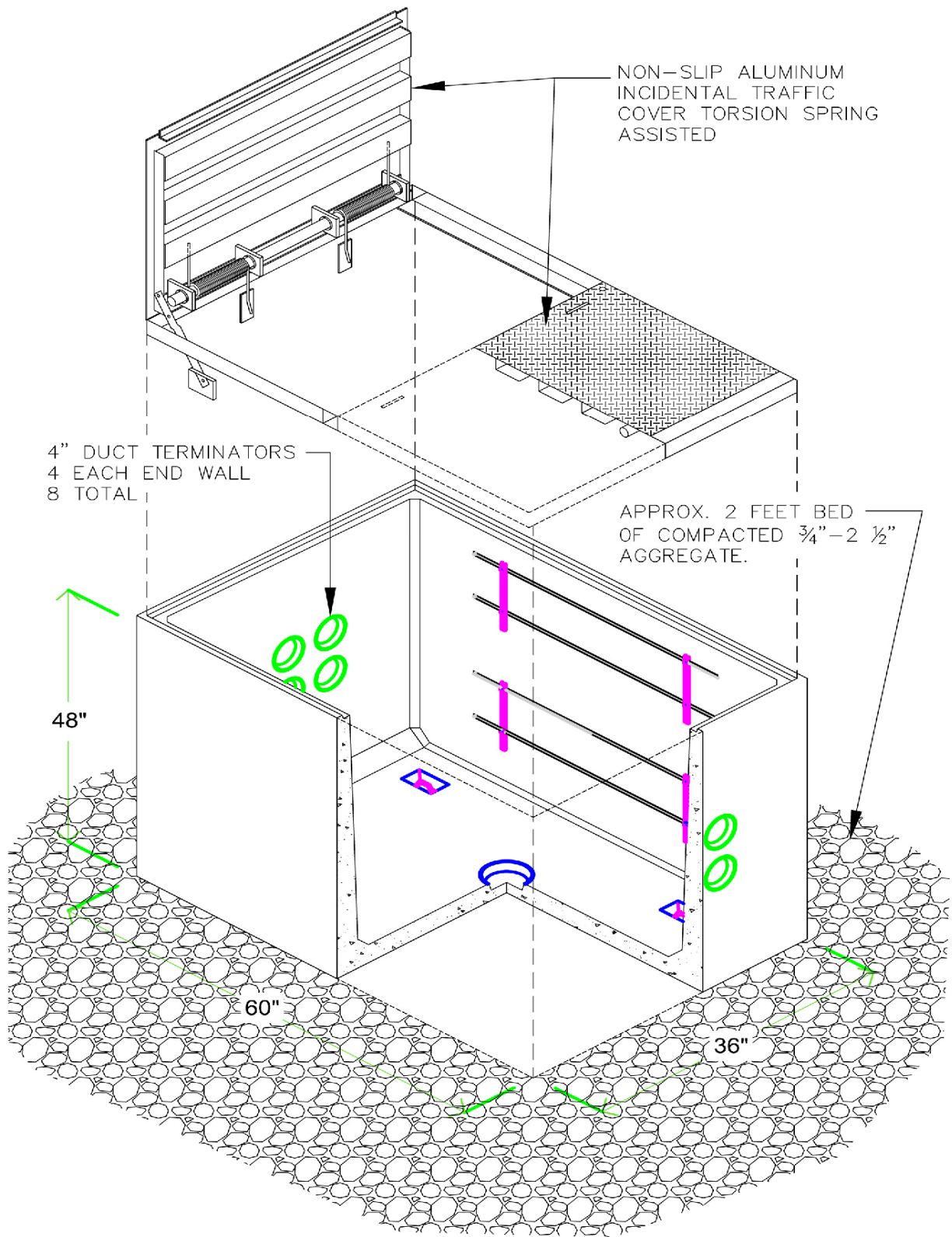

Diagram of Hand Hole requirements.



A newly installed Hand Hole for 2 entry and 2 exit conduits and awaiting cable racks.

- 2.29.3. HH's and their covers shall be rated for the area used. HH's installed in streets shall be traffic rated.
- 2.29.4. HH's installed on the airfield shall be aircraft rated.
- 2.29.5. HH's shall have four (4) 4-inch entry conduits and four (4) 4-inch exit conduits installed along the main path. Branch conduits are additional. Conduits shall be encased in concrete.
- 2.29.6. HH's shall maintain a 12-inch separation when running parallel to utilities and 6-inch separation when running perpendicular to utilities.
- 2.29.7. HH conduit shall have three 3-inch 3-cell MaxCell fabric innerduct installed in one 4-inch conduit through the entire length of the conduit run.

- 2.29.8. The location of all underground Hand Holes shall be identified by two methods – XY coordinates utilizing the California State Plane Coordinate System, Zone V (CA83-IVF), and by Latitude/Longitude with an accuracy of 12-inches. Z values and invert elevations shall be provided in U.S. foot/inch measurements.
- 2.29.9. An online converter like Earthpoint (<http://www.earthpoint.us/>) (<http://www.earthpoint.us/StatePlane.aspx>) or equivalent can be used to create the state plane coordinates from Lat/Long.
- 2.29.10. Coordinates shall be documented on the drawings and in a separate spreadsheet.

2.30. L&S > HAND HOLES > SPACING

- 2.30.1. Underground Hand Holes shall be spaced not to exceed 400 feet apart.

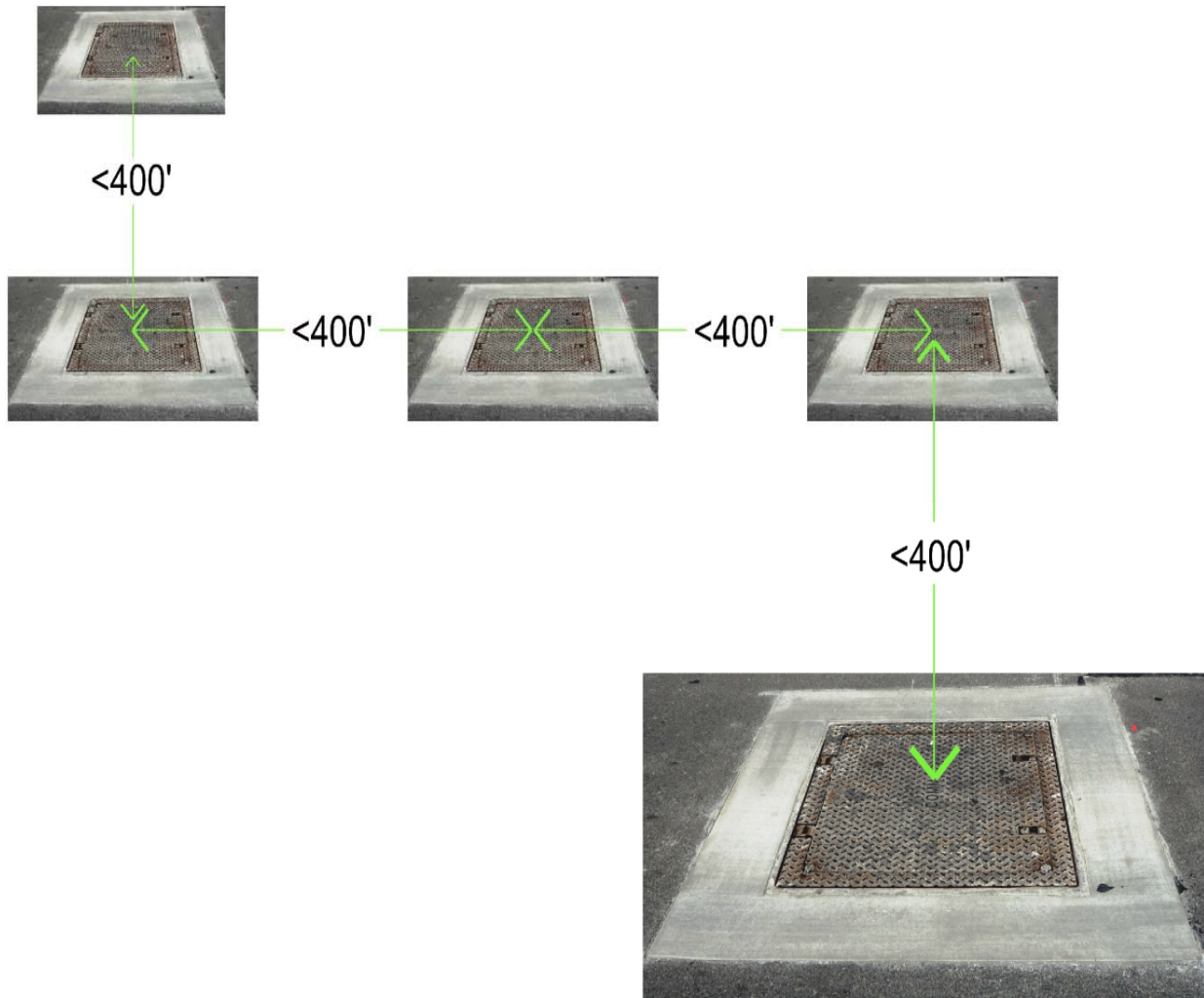

Hand Hole spacing shall not exceed 400 ft.

2.31. L&S > MAINTENANCE HOLES

2.31.1. Communication MH's are used in locations where:

- More than 4 entry and 4 exit conduits are required
- Replacement for legacy MH's that need to be demolished
- Splice cases are required
- As a hub for HH's

2.31.2. MH's shall be poured (cast) concrete and have the following requirements:

- A minimum size of 72" W x 96" L x 84" H.
- Ladder
- Cable mounting racks rated for a minimum of 400 lbs. weight
- Cable pulling eyes
- Drain/sump hole
- Round or rectangular covers
- Torsion spring assist for rectangular covers
- "COMM" welded on the top cover

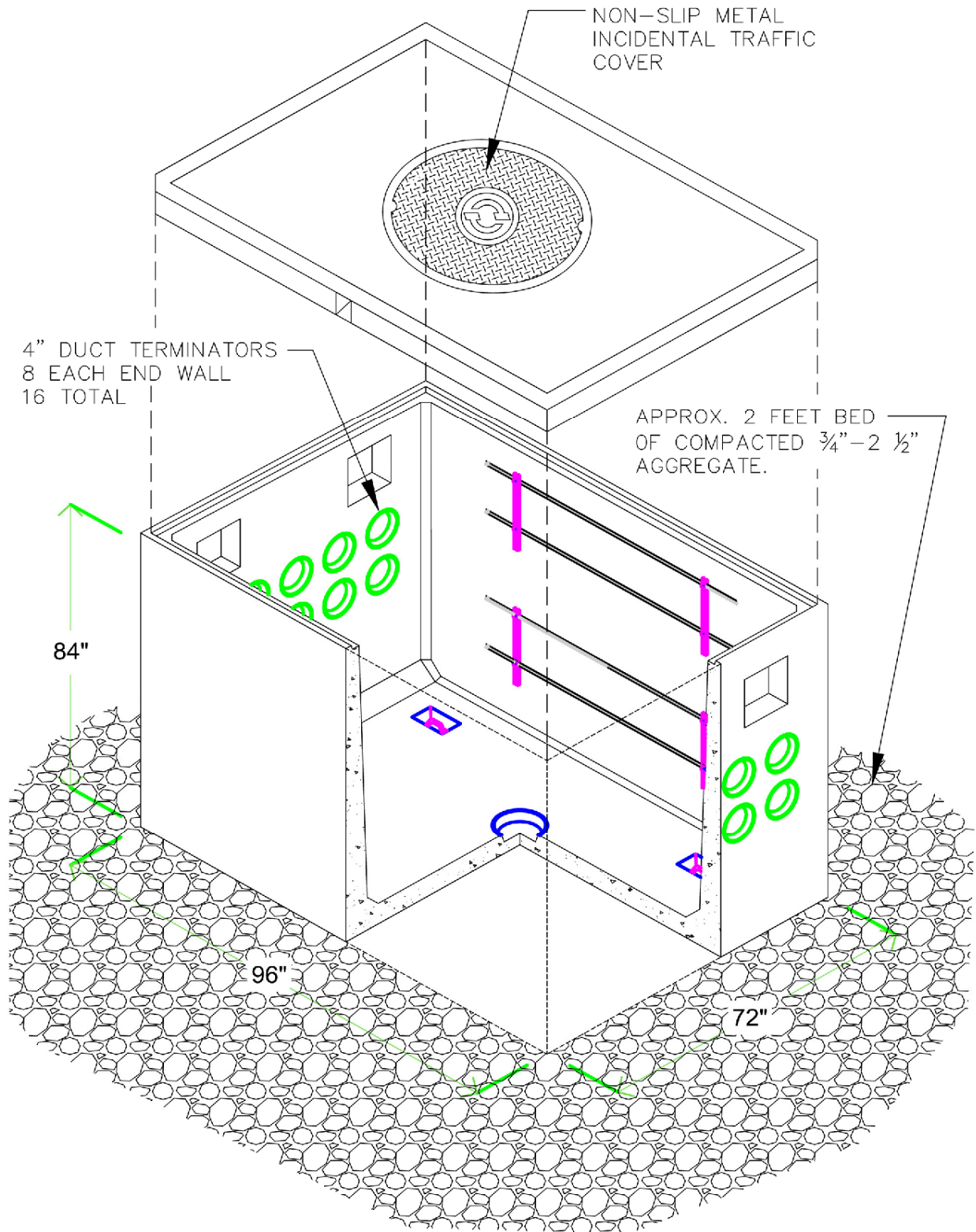

Diagram of Maintenance Hole minimum requirements.

COMMUNICATION MANHOLE STANDARD

NOTES:

- MANHOLE DESIGNED IN ACCORDANCE WITH AASHTO LOAD FACTOR METHOD. USING 5,500 PSI COMPRESSIVE STRENGTH CONCRETE AND 60,000 PSI YIELD STRENGTH ASTM A-706 STEEL REINFORCEMENT PER CALCS. #31986.
- VAULT TO BE PLACED ON A 24" BASE OF CRUSHER RUN FOR EASE OF INSTALLATION AND EVEN LOAD DISTRIBUTION.

ORDERING INFORMATION:

68FV84-LAWA FOR ASSEMBLY AS SHOWN.
TOTAL WEIGHT OF ASSEMBLY SHOWN IS 33,850 lbs.

1. UV68-B36-LAWA, 36" BOTTOM SECTION (R68-B36-LAWA). WT. 14,600 lbs.
2. UV68-T48-LAWA, 48" TOP SECTION (R68-T48-LAWA). WT. 17,150 lbs.
3. DIPB3636-R6, 6" RISER SECTION. WT 525 lbs.
4. PB3636-T12H, 12" TOP RING. W/ AIRCRAFT RATED COVER CAST-IN. WT. 1,530 lbs.
5. DUCTILE IRON 36" X 36" AIRPORT SPRING ASSISTED HATCH.
6. 12" SUMP KNOCKOUT W/ GRATE. LOCATE AS FOLLOWS: BOTTOM SECTION (1) CORE MTD.
7. 4" DIA TERMINATOR SCH. 40. BOTTOM SECTION (16) SHELL MTD. TOP SECTION (32) SHELL MTD.
8. 1" DIA. GROUND ROD KNOCKOUT. LOCATE AS FOLLOWS: BOTTOM SECTION (2) CORE MTD.
9. 1/2" PLASTIC INSERT. LOCATE AS FOLLOWS: TOP SECTION (20) CORE MTD.; BOTTOM SECTION (10) CORE MTD.
10. 7/8" x 3 3/8" PULL IRON. LOCATE AS FOLLOWS: BOTTOM SECTION (2) CORE MTD.
11. 16" x 24" KNOCKOUTS. LOCATE AS FOLLOWS: TOP SECTION (2) CORE MTD.
12. 4 TON x 9 1/2" GALV. RISS FOR HANDLING. LOCATE AS FOLLOWS: BOTTOM SECTION (4) SURFACE MTD.; TOP SECTION (4) SURFACE MTD.
13. 4 TON x 4 3/4" GALV. RISS FOR HANDLING. LOCATE AS FOLLOWS: BOTTOM SECTION (4) CORE MTD.

6'-0" X 8'-0" VAULT X 7'-0" DEEP

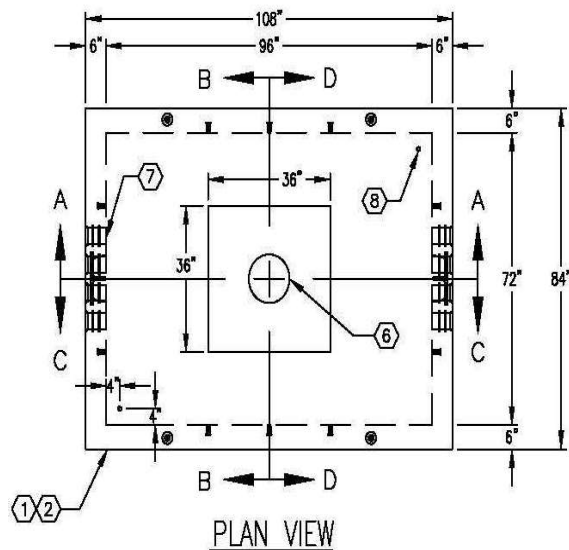

MINIMUM EXCAVATION SIZE:
8'-0" x 13'-6" x DEPTH REQ'D.



A manufacturer's cut sheet for an aircraft-rated Maintenance Hole and cover for LAWA.

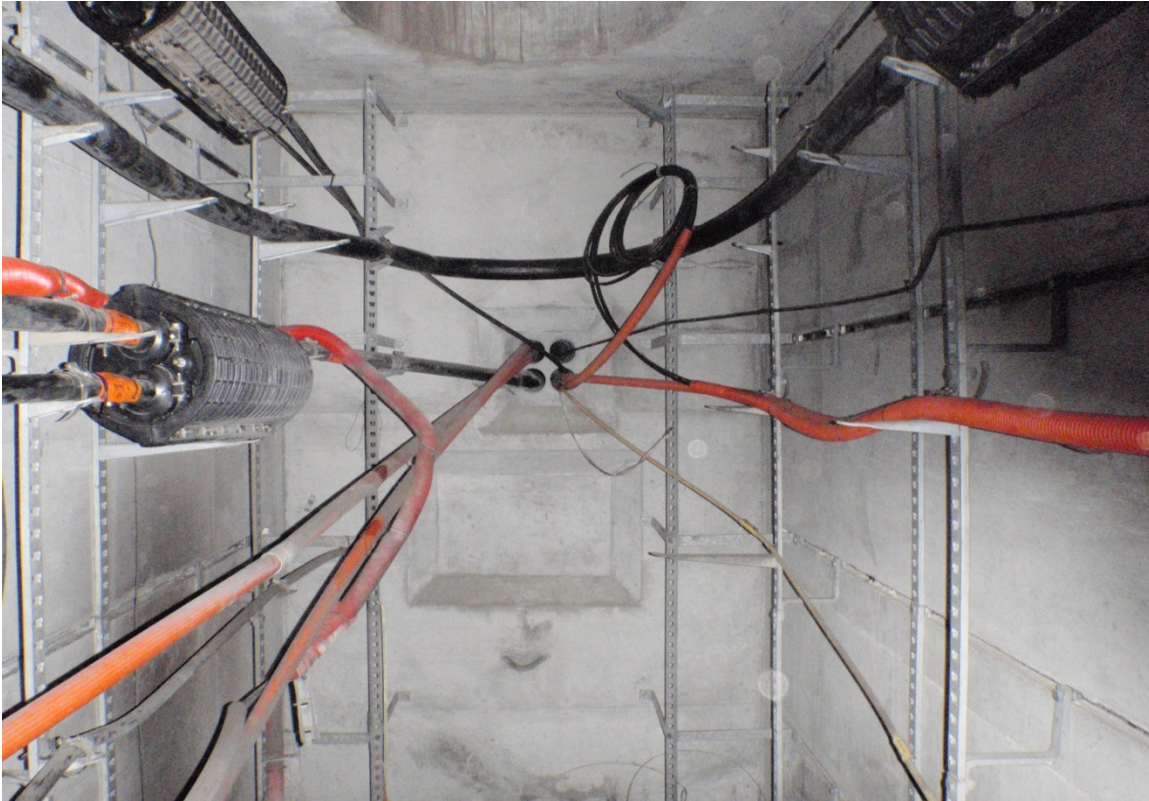

A Maintenance Hole with 4 entry and 4 exit conduits plus 3 splice cases. Ladder is removed.

2.31.3. MH's and their covers shall be rated for the area used. MH's installed in streets shall be traffic rated. MH's installed on the airfield shall be aircraft rated.

2.31.4. MH's shall be stamped inside with the installation date in 2-inch letters.



Maintenance Hole with a square cover and torsion spring assisted opening.



Deeper Maintenance Holes may need to be built up using pre-casted sections as shown here.



Maintenance Holes require cable mounting racks on both sides able to support 400 lbs each.

- 2.31.5. In airport perimeter areas, MH's shall have a minimum of four 4-inch entry conduits and four 4-inch exit conduits installed. In airport central areas, MH's shall have a minimum of sixteen (16) 4-inch entry conduits and sixteen (16) 4-inch exit conduits installed arranged in a 4x4 matrix. Additionally, all branch conduits shall be 4-inch in size. Conduits shall be encased in concrete.
- 2.31.6. In airport perimeter areas, MH conduit shall have three 3-inch 3-cell MaxCell fabric innerduct installed in one 4-inch conduit through the entire length of the conduit run. In airport central areas, MH conduit shall have three 3-inch 3-cell MaxCell fabric innerduct installed in three (3) 4-inch conduits through the entire length of the conduit run.
- 2.31.7. MH's shall maintain a 12-inch separation when running parallel to utilities and 6-inch separation when running perpendicular to utilities.
- 2.31.8. The location of all underground Maintenance Holes shall be identified by two methods – XY coordinates utilizing the California State Plane Coordinate System, Zone V (CA83-IVF), and by Latitude/Longitude with an accuracy of 12-inches. Z values and invert elevations shall be provided in U.S. foot/inch measurements. An online converter like Earthpoint (<http://www.earthpoint.us/>) (<http://www.earthpoint.us/StatePlane.aspx>) or equivalent can be used to create the state plane coordinates from Lat/Long.
- 2.31.9. Coordinates shall be documented on the drawings and in a separate spreadsheet provided to LAWA.

2.32. L&S > MAINTENANCE HOLES > SPACING

- 2.32.1. Underground MH's shall be spaced not to exceed 400 feet apart.

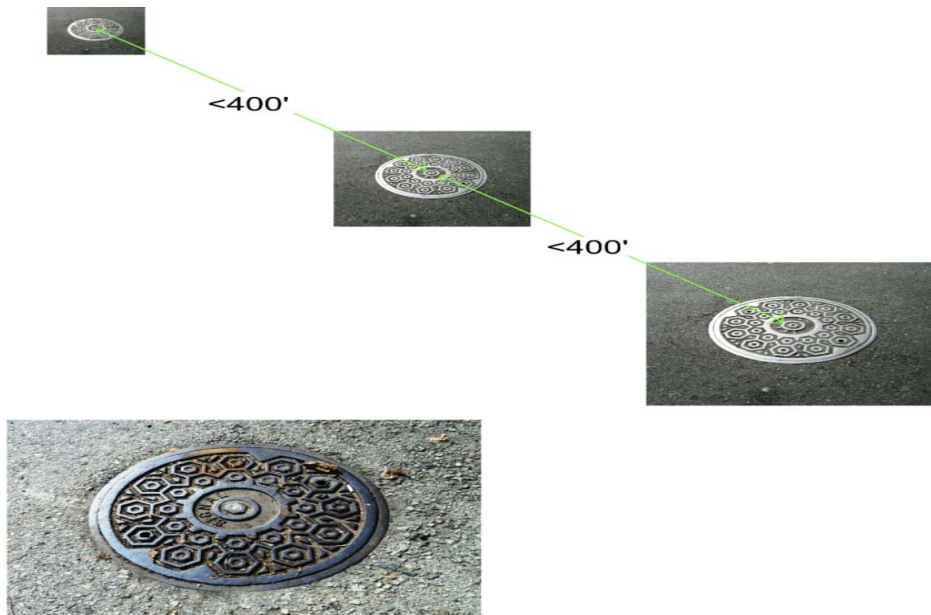

Maintenance Hole spacing shall not exceed 400 ft.

2.33. L&S > DATA CENTERS

- 2.33.1. Data Center designers shall have the current Accredited Tier Designer (ATD) accreditation from the Uptime Institute.
- 2.33.2. Data center design options shall be vetted by a LAWA-approved independent expert evaluation using the FORCSS (Financial, Opportunity, Risk, Compliance, Sustainability, and Service Quality) system.
- 2.33.3. Data Centers shall be designed to meet Tier 4 Fault Tolerance requirements as stated by the Uptime Institute.
- 2.33.4. Data Center design shall include adherence to the ANSI/BICSI 002-2011 (or current) Data Center Design and Implementation Best Practices Standards.



The latest data center standard.

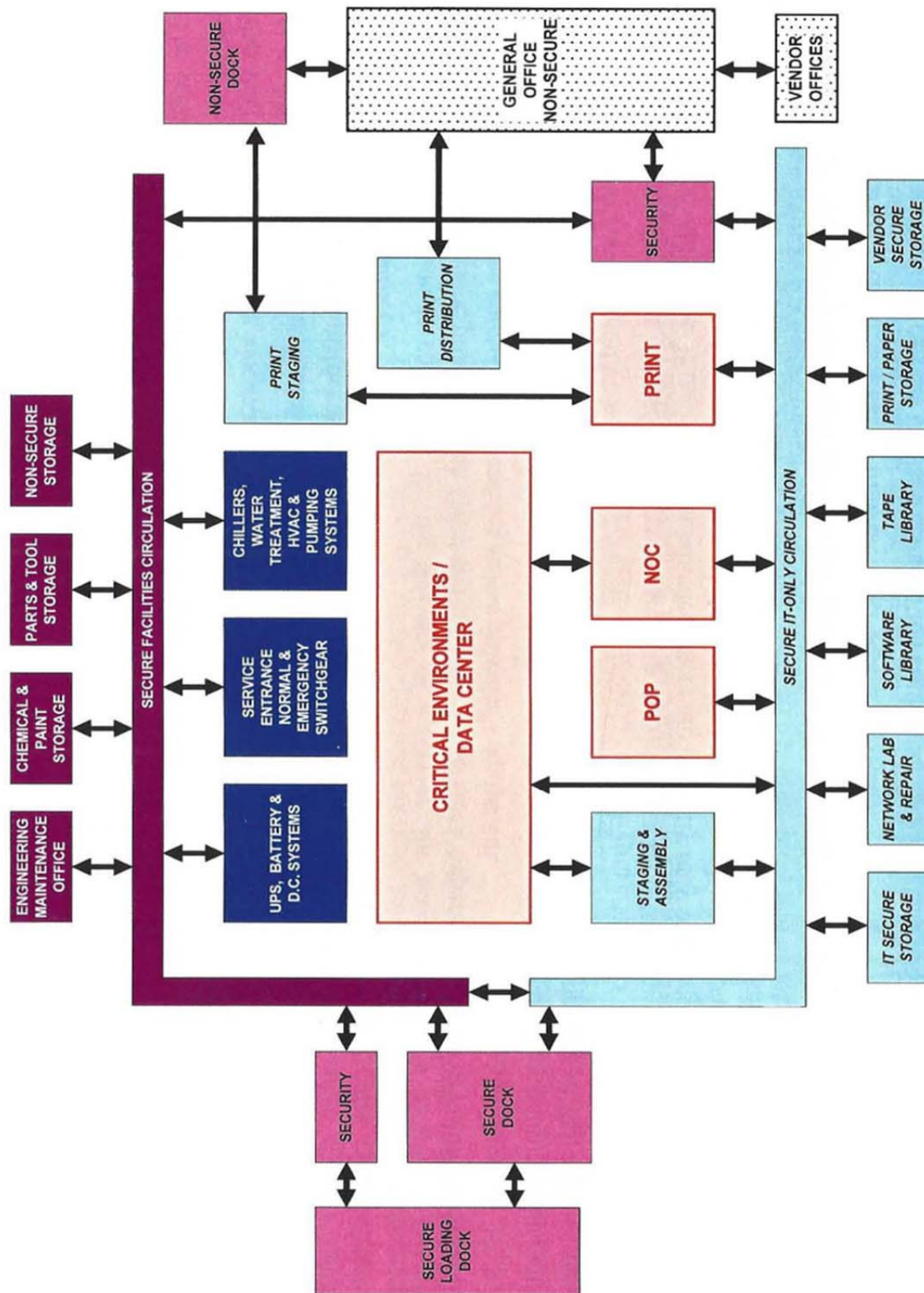

Data Center block diagram. Source: ANS/BICSI 002-2010 & 2011 Data Center Design and Implementation Best Practices Standard.

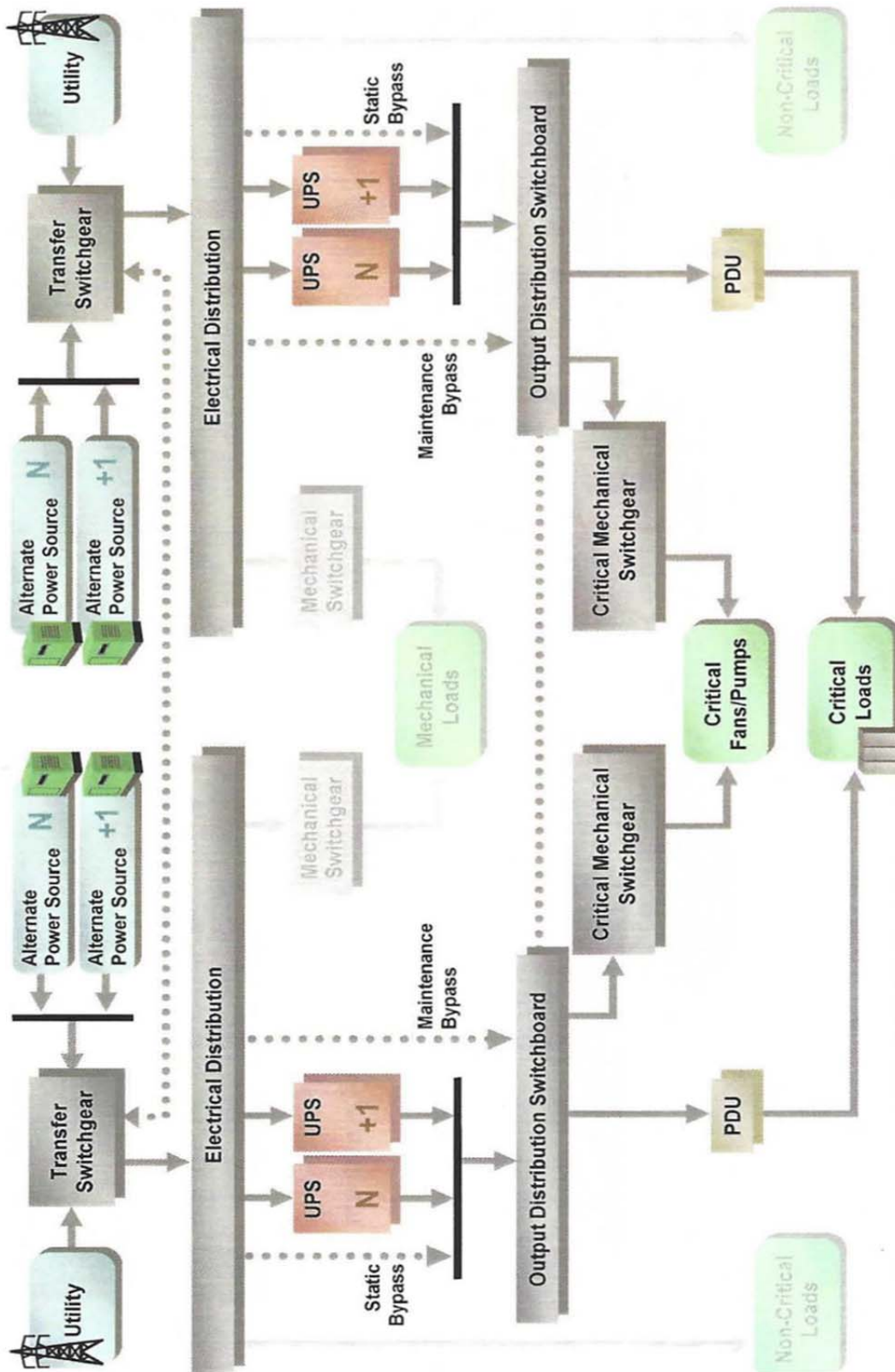

Data Center utility diagram. Source: *ANSI/BICSI 002-2011 Data Center Design and Implementation Best Practices Standard.*

2.34. L&S > DATA CENTERS > ACCESS FLOOR

- 2.34.1. Data Centers may or may not have raised access floors – depending upon the design previously approved by LAWA.
- 2.34.2. Data Centers with raised access floors shall have equipment cabinets anchored to meet local seismic codes.

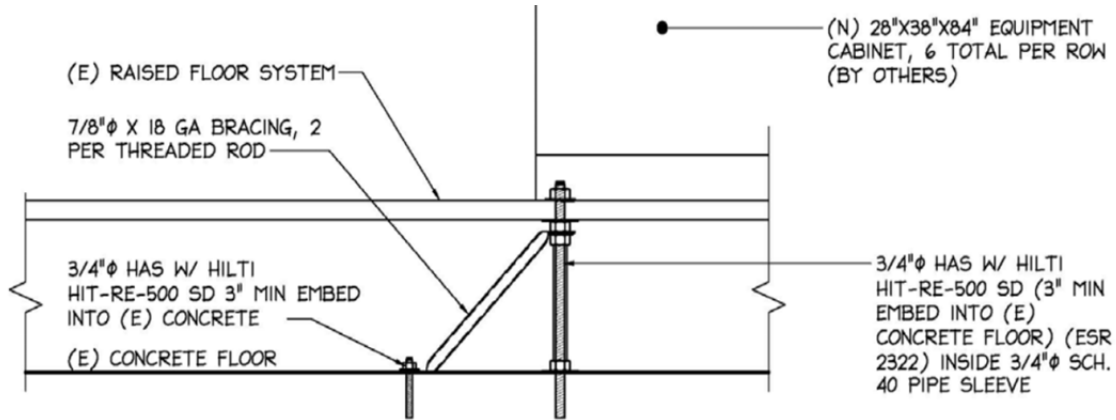

ANCHORAGE DETAIL

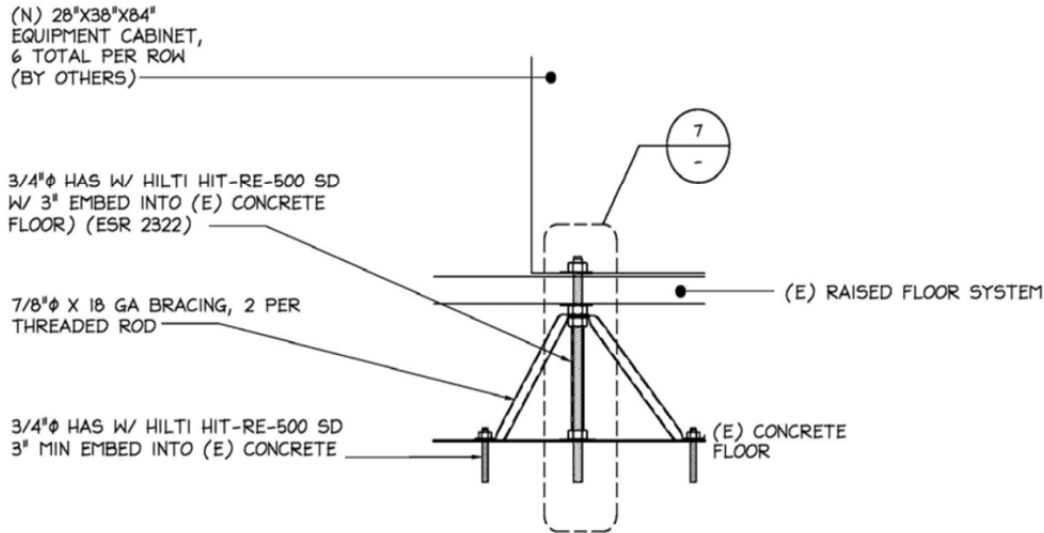

ANCHORAGE DETAIL

DESCRIPTION	MANUFACTURER	PART #
7/8" DIA X 18 GA BRACE	B&E ENTERPRISES	SPECIAL 10
3/4" DIA, 24" LENGTH, THREADED ROD	CROWN BOLT	17220
EPOXY	HILTI	HIT-RE-500 SD

PARTS LIST

Sample detail from a structural calculation package for an access floor.



Diagonal seismic supports for equipment cabinets above a raised access floor.

- 2.34.3. Raised access floors shall have seismic anchoring details included in the as-built drawings.

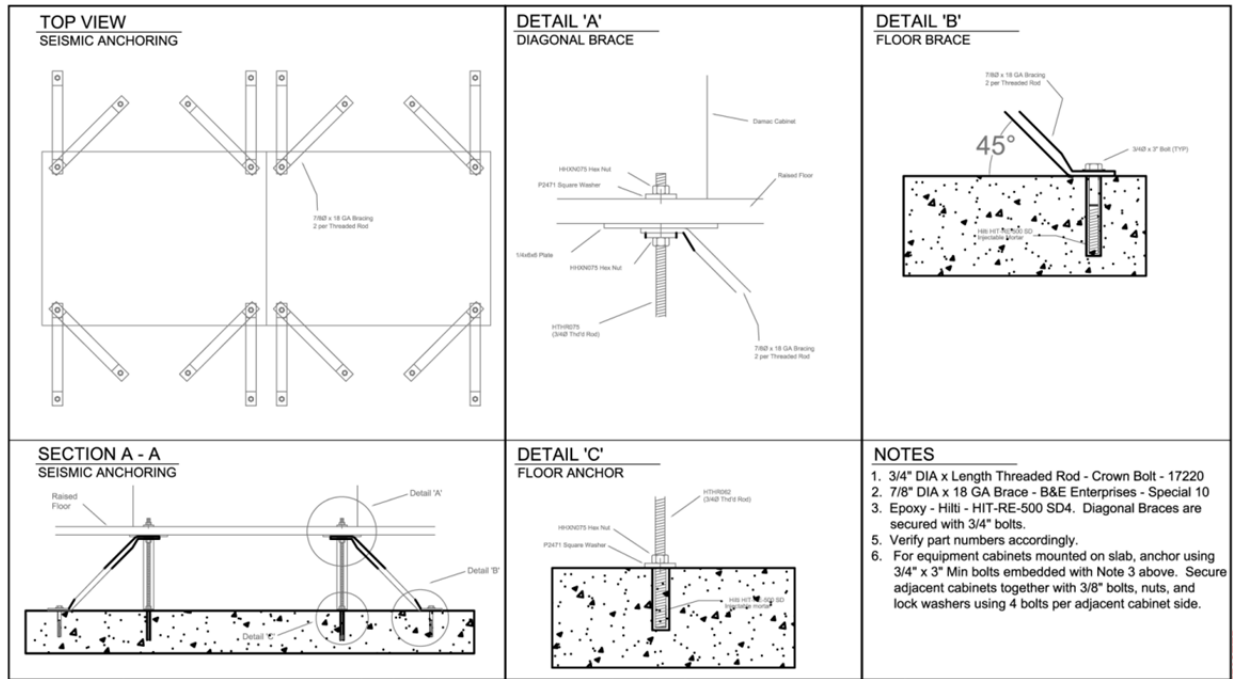

Sample seismic anchoring detail as required for as-built drawings.

- 2.34.4. Control Centers may have a low profile 6-inch raised access floor – if the ceiling is at least nine (9) feet high.
- 2.34.5. Panels shall be rated at 1000 pounds per square inch minimum.
- 2.34.6. Raised floor shall be grounded.
- 2.34.7. Raised floor shall use fire-resistant grommets - preferably brush type - to pass cables.
- 2.34.8. Underfloor shall use minimum 6-inch to 12-inch wire basket or built-in cable pathway.
- 2.34.9. Three (3) Tile and/or carpet pullers shall be provided per each IT room that serves the raised floor area.

2.35. L&S > DISTRIBUTED ANTENNA SYSTEM IT ROOMS

- 2.35.1. A Distributed Antenna System (DAS) is a system that allow multiple cell phone carrier and other radio signals to be transmitted and received over a common infrastructure and network of antennas.
- 2.35.2. DAS system design shall follow the latest ANSI/BICSI DAS Design and Implementation Best Practices standard.



DAS design shall adhere to the latest DAS standards.

2.35.3. DAS systems shall provide ubiquitous coverage for cellular phone providers, and fire and police first responders.

2.35.4. The diagram below shows the basic components included in a DAS:

- Head-end equipment
- Back-end (distribution) equipment
- Infrastructure - indoor and outdoor
- Antennas - indoor and outdoor

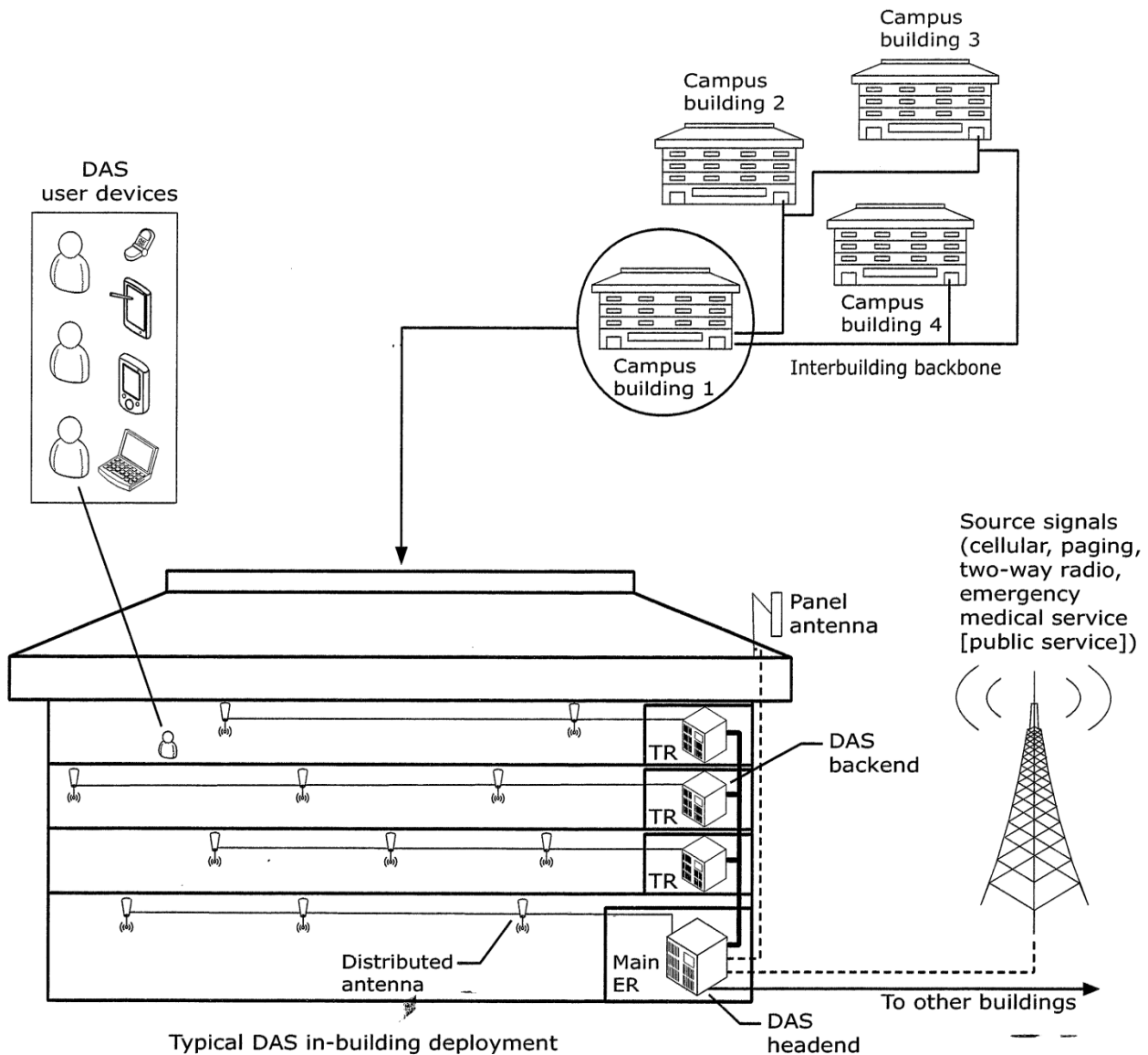

DAS = Distributed antenna system
ER = Equipment room
TR = Telecommunications room

A sample Distributed Antenna System diagram is shown. Source: BICSI TDMM, 13th edition.

- 2.35.5. All major cell phone carriers shall be consulted for their individual and collective infrastructure, utility, and space requirements.
- 2.35.6. All passenger terminals and mission-critical facilities shall have a Distributed Antenna Systems. Mission-critical facilities requiring a DAS shall be determined by LAWA.
- 2.35.7. All passenger terminals and mission-critical facilities shall have a dedicated DAS head-end room unless provisions have been made to locate the DAS head-end room outside of the terminal or facility.
- 2.35.8. DAS head-end rooms shall be sized to accommodate a minimum of 200 square feet per cell phone carrier, and a minimum of 1,000 square feet overall unless a greater size is required.
- 2.35.9. Floor loading for DAS shall be 125 pounds per square inch.
- 2.35.10. DAS head-end rooms shall have electrical service of a minimum of 100 to 150 amps of 208 volt 3-phase power per carrier or as required by individual carriers.
- 2.35.11. DAS head-end rooms shall have a telecommunications grounding busbar that is tied into the building telecommunications grounding system.
- 2.35.12. DAS head-end rooms shall have a minimum of 2 tons of HVAC per carrier or greater if required by individual carriers.
- 2.35.13. DAS Head-end room HVAC shall be backed up by building generator. If a building generator is not yet installed then a portable generator shall be used.
- 2.35.14. DAS head-end rooms shall have a UPS installed sufficient for ten minutes full load to cover generator startup.
- 2.35.15. DAS head-end rooms shall comply with MPOE and IT Room Common Element requirements.
- 2.35.16. DAS head-end rooms shall have a minimum of two 4-inch conduits to the MPOE in addition to the conduits required by the cell phone carriers.
- 2.35.17. DAS distribution equipment shall reside in local IT Rooms.
- 2.35.18. Passenger terminals and mission-critical facilities shall have infrastructure placement designed according to the acceptable coverage of Received Signal Strength Indicator (RSSI) surveys for the respective radio frequencies.

2.36. L&S > COMMON ELEMENTS

2.36.1. Common Elements are those components that are common to MPOE's, and IT Rooms.

2.36.2. Common Element topics are organized alphabetically and include:

- Access
- Access Policy
- Access Floors
- Cabinets
- Cabinet Conduit
- Cabinet Electrical
- Cabinet Grounding
- Cabinet Lighting
- Ceilings
- Dividers
- Doors
- Electrical
- Electromagnetic Radiation
- Equipment Racks
- Fire Protection
- Floors
- Grounding
- Hazardous Materials
- Lighting
- Liquids
- Positive Pressure Ventilation
- Security Monitoring
- Telephones
- Uninterruptible Power Supplies
- Walls
- Windows

2.37. L&S > COMMON ELEMENTS > ACCESS

- 2.37.1. IT Rooms shall have ACAMS proximity card reader access. Door cylinders shall be keyed to the latest dedicated IT room key.

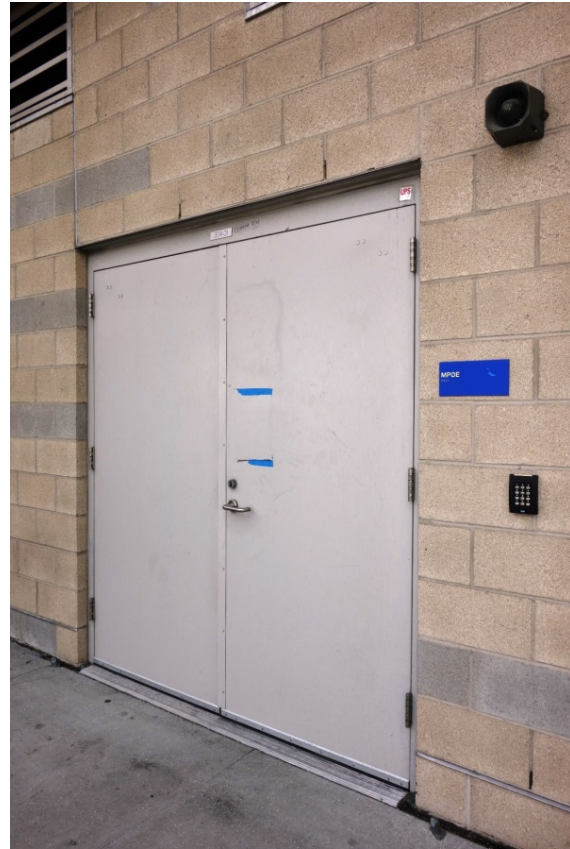

ACAMS card readers are shown outside an IT Room and an MPOE.

- 2.37.2. Doors shall not use cypher locks.
- 2.37.3. Card readers and their associated door hardware and micro-controller hardware shall conform to LAWA's existing ACAMS system.
- 2.37.4. LAWA's existing ACAMS maintenance contractor shall be contracted with to make to perform the necessary decommissioning, connections, configurations, programming, and testing.
- 2.37.5. IT rooms shall be accessible from a corridor, stairwell, and/or a service elevator.
- 2.37.6. IT Rooms shall not be constructed so that access is through a tenant area.
- 2.37.7. Access to IT Rooms, MPOE'S, and TCWC's shall be controlled by ACAMS card readers installed on LAWA's ACAMS system.



ACAMS card reader on a cage.



Legacy access control infrastructure installed as per previous LAWA requirements.



NOTES

1. 3/4" HOLE TO BE PROVIDED IN DOOR FRAME AND DOOR FOR DOOR CONTACT SWITCH 6" FROM EDGE OF DOOR. C/L OF 3/4" HOLES TO ALIGN.
2. LOCAL ALARM / SOUNDER, BACK TO BOX TO BE SINGLE GANG BOX.
3. ELECTRIC MORTISE LOCK
4. CARD READER BACK BOX TO BE SINGLE GANG BOX FOR HID R40 / RK40 iCLASS SERIES CARD READERS. DISTANCE BETWEEN DEVICES TO BE A MIN. 6" HEIGHT TYP. 42" TO 48" AFF TO CENTER. HEIGHT TO BE FIELD VERIFIED TO MATCH OTHER TYP. WALL PLATES / LIGHT SWITCHES FOR CONSISTENT APPEARANCE AND ADA COMPLIANCE.
5. 16" x 16" x 6.62" SJB IN ACCESSIBLE AREA WITHIN 25 FT. OF DOOR MOUNTED NO HIGHER THAN 10FT. AFF. FOR SERVICE ACCESS. SJB TO BE HOFFMAN MODEL A16N16ALP C / W HOFFMAN A16N16MPP PERFORATED BACKPLATE, AL12AR CYLINDER LOCK AND TAMPER SWITCH.

CR	CK	LA	REX	DC	CABLE TYPE
1	1	1	0	1	20 / 6
					18 / 2
					22 / 2
					CAT6A
					2
					3
					1
					2

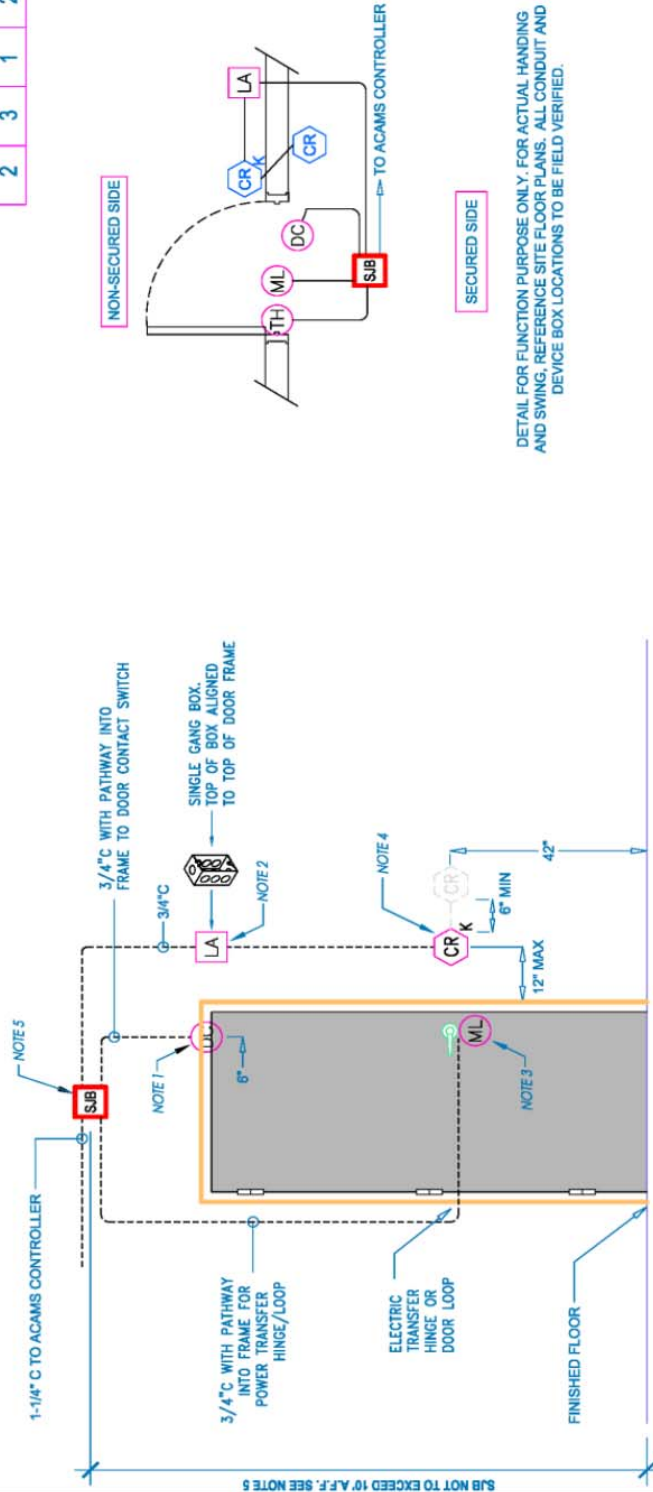

DETAIL FOR FUNCTION PURPOSE ONLY. FOR ACTUAL HANDLING AND SWING, REFERENCE SITE FLOOR PLANS. ALL CONDUIT AND DEVICE BOX LOCATIONS TO BE FIELD VERIFIED.

1 SINGLE DOOR WITH iCLASS IN AND OUT CARD READERS AND ELECTRIC MORTISE LOCK
SCALE : 3/8" = 1'-0"

ACAMS infrastructure detail for a single door with in/ out card readers and electric mortise lock.



NOTES

1. 3/4" HOLE TO BE PROVIDED IN DOOR FRAME AND DOOR FOR DOOR CONTACT SWITCH 6" FROM EDGE OF DOOR. C/L OF 3/4" HOLES TO ALIGN.
2. LOCAL ALARM / SOUNDER, BACK TO BOX TO BE SINGLE GANG BOX.
3. ELECTRIC MORTISE LOCK
4. CARD READER BACK BOX TO BE SINGLE GANG BOX FOR HID R40 / RK40 iCLASS SERIES CARD READERS. DISTANCE BETWEEN DEVICES TO BE A MIN. OF 6" HEIGHT TYP. 42" TO 48" AFF TO CENTER. HEIGHT TO BE FIELD VERIFIED TO MATCH OTHER TYP. WALL PLATES / LIGHT SWITCHES FOR CONSISTENT APPEARANCE AND ADA COMPLIANCE
5. 16" x 16" x 6.62" SJB IN ACCESSIBLE AREA WITHIN 25 FT. OF DOOR MOUNTED NO HIGHER THAN 10FT. AFF. FOR SERVICE ACCESS. SJB TO BE HOFFMAN MODEL A16N16ALP C / W HOFFMAN A16N16MPP PERFORATED BACKPLATE, AL12AR CYLINDER LOCK AND TAMPER SWITCH.

CR	CK	LA	REX	DC	CABLE TYPE
1	1	1	0	2	20/6
					18/2
					22/2
					CAT6A
				2	3
					1
					2

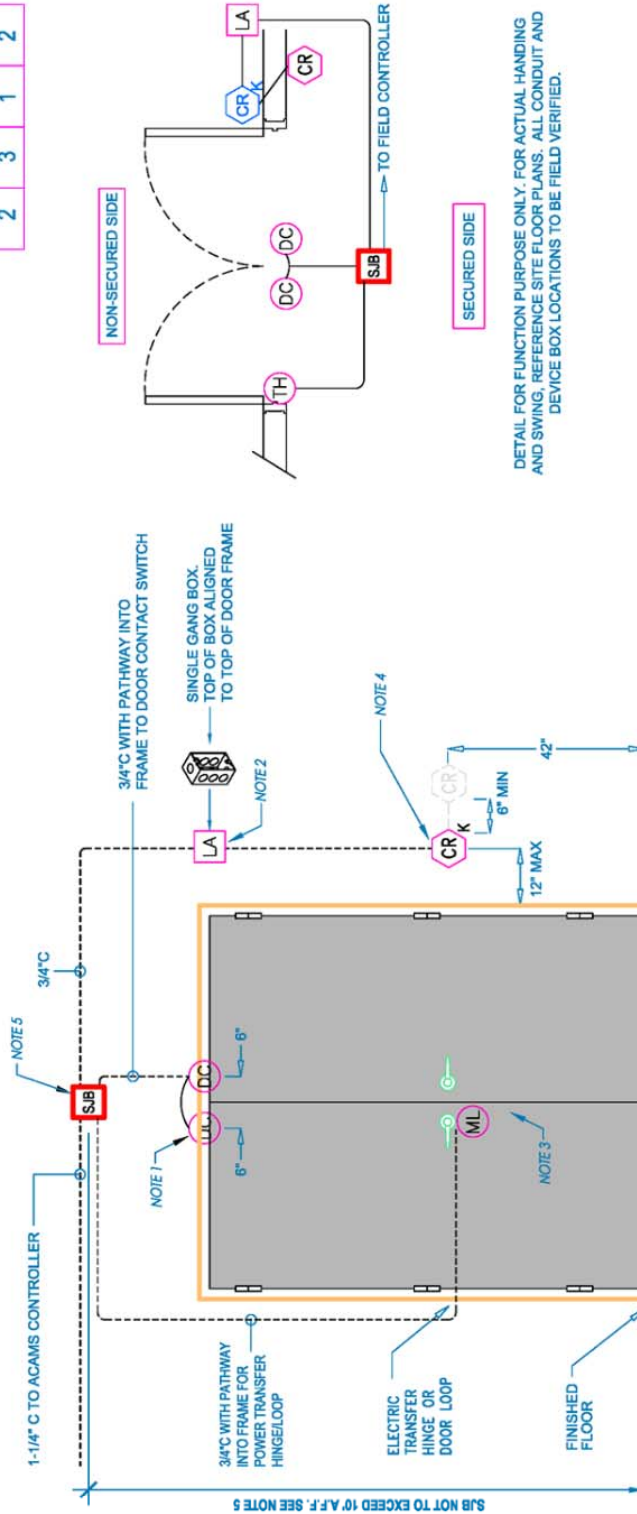

DETAIL FOR FUNCTION PURPOSE ONLY. FOR ACTUAL HANDLING AND SWING, REFERENCE SITE FLOOR PLANS. ALL CONDUIT AND DEVICE BOX LOCATIONS TO BE FIELD VERIFIED.

2 DOUBLE DOOR WITH iCLASS IN & OUT CARD READERS AND ELECTRIC MORTISE LOCK

SCALE : 3/8" = 1'-0"

ACAMS infrastructure detail for a double door with in/out card readers and electric mortise lock.



NOTES

1. 3/4" HOLE TO BE PROVIDED IN DOOR FRAME AND DOOR FOR DOOR CONTACT SWITCH 6" FROM EDGE OF DOOR. C/L OF 3/4" HOLES TO ALIGN.
2. LOCAL ALARM / SOUNDER, BACK TO BOX TO BE SINGLE GANG BOX.
3. ACCESS SYSTEM TO PROVIDE (1) SET OF DRY CONTACTS (N/O THAT CLOSE UPON ACTIVATION) TO PANIC HDW POWER SUPPLY. VERIFY CONTACT RATING REQUIRED FOR DOOR CONTROLLER.
4. PANIC HDW VON DUPRIN POWER SUPPLY WILL REQUIRE (1) 120VAC POWER CIRCUIT. (SUPPLIED & INSTALLED BY OTHERS) SEE MANUFACTURERS REQUIREMENTS FOR LOAD.
5. CARD READER BACK BOX TO BE SINGLE GANG BOX FOR HID R40 / RK40 ICLASS SERIES CARD READERS. DISTANCE BETWEEN DEVICES TO BE A MIN. OF 6" HEIGHT TYP. 42" TO 48" AFF TO CENTER. HEIGHT TO BE FIELD VERIFIED TO MATCH OTHER TYP. WALL PLATES / LIGHT SWITCHES FOR CONSISTENT APPEARANCE AND ADA COMPLIANCE.
6. 16" x 16" x 6.62" SJB IN ACCESSIBLE AREA WITHIN 25 FT. OF DOOR. MOUNTED NO HIGHER THAN 10FT. AFF. FOR SERVICE ACCESS. SJB TO BE HOFFMAN MODEL A16N16ALP C / W HOFFMAN A16N16MP PERFORATED BACKPLATE, AL12AR CYLINDER LOCK AND TAMPER SWITCH.

CR	CK	LA	REX	DC	CABLE TYPE
1	1	1	0	1	20/6 18/2 22/2 CAT6A
2	3	1	2	1	2

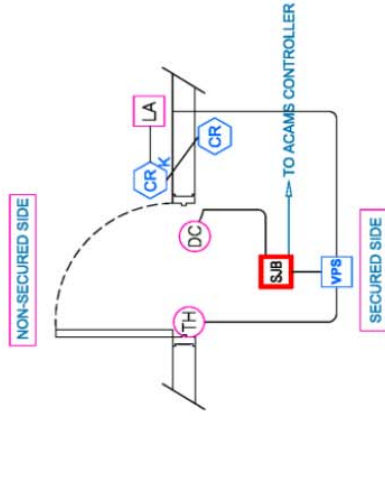
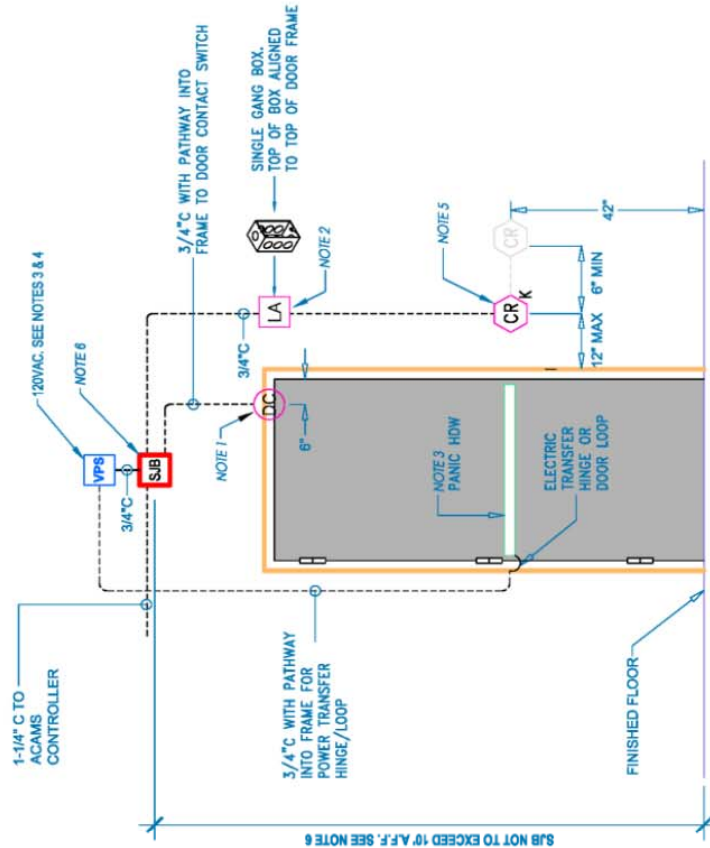

DETAIL FOR FUNCTION PURPOSE ONLY. FOR ACTUAL HANDING AND SWING, REFERENCE SITE FLOOR PLANS. ALL CONDUIT AND DEVICE BOX LOCATIONS TO BE FIELD VERIFIED.

3

SINGLE DOOR WITH ICLASS IN & OUT CARD READERS AND PANIC HARDWARE

SCALE : 3/8" = 1'-0"

ACAMS infrastructure detail for a single door with in/out card readers and panic hardware.



NOTES

- 3/4" HOLE TO BE PROVIDED IN DOOR FRAME AND DOOR FOR DOOR CONTACT SWITCH 6" FROM EDGE OF DOOR. C/L OF 3/4" HOLES TO ALIGN. MODEL 1078C-M TO SJB WIU-4 BOARD.
- LOCAL ALARM / SOUNDER, BACK TO BOX TO BE SINGLE GANG BOX.
- ACCESS SYSTEM TO PROVIDE (1) SET OF DRY CONTACTS (N/O THAT CLOSE UPON ACTIVATION) TO PANIC HDW VON DUPRIN POWER SUPPLY. VERIFY CONTACT RATING REQUIRED FOR DOOR CONTROLLER.
- PANIC HDW VON DUPRIN POWER SUPPLY WILL REQUIRE (1) 120VAC POWER CIRCUIT. (SUPPLIED & INSTALLED BY OTHERS) SEE MANUFACTURERS REQUIREMENTS FOR LOAD.
- CARD READER BACK BOX TO BE SINGLE GANG BOX FOR HID R40 / RK40 iCLASS SERIES CARD READERS. DISTANCE BETWEEN DEVICES TO BE A MIN. OF 6" HEIGHT TYP. 42" TO 48" AFF TO CENTER. HEIGHT TO BE FIELD VERIFIED TO MATCH OTHER TYP. WALL PLATES / LIGHT SWITCHES FOR CONSISTENT APPEARANCE AND ADA COMPLIANCE
- 16" x 16" x 6.62" SJB IN ACCESSIBLE AREA WITHIN 25 FT. OF DOOR MOUNTED NO HIGHER THAN 10FT. AFF. FOR SERVICE ACCESS. SJB TO BE HOFFMAN MODEL A16N16ALP C / W HOFFMAN MODEL A16N16MPP PERFORATED BACKPLATE, AL12AR CYLINDER LOCK AND TAMPER SWITCH.

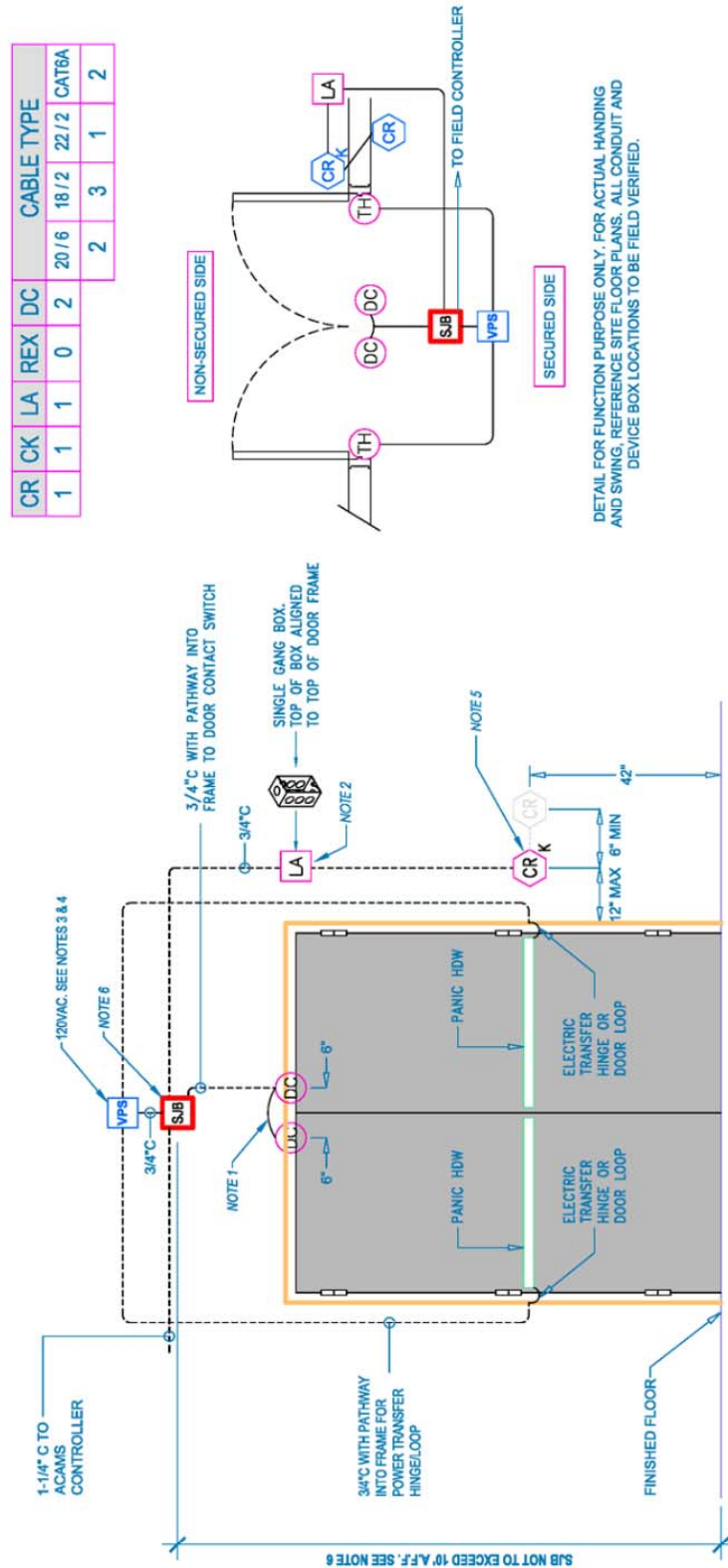

4 DOUBLE DOOR WITH iCLASS IN & OUT CARD READERS AND PANIC HARDWARE
SCALE : 3/8" = 1'-0"

ACAMS infrastructure detail for a double door with in/out card readers and panic hardware.



NOTES

1. ONE (1) GANG BOX C/W BLANK COVER PLATE. BOX TO BE WITHIN 2" OF DOOR FRAME AND 6" AFF.
2. SURFACE MOUNTED DOOR CONTACT SWITCH WITH ARMORED CABLE TO GANG BOX
3. LOCAL ALARM BACK BOX TO BE SINGLE GANG
4. CARD READER BACK BOX TO BE SINGLE GANG BOX TO BE MINIMUM OF 42" HEIGHT AFF. HEIGHT TO BE FIELD VERIFIED TO MATCH OTHER TYPICAL WALL PLATES / LIGHT SWITCHES FOR CONSISTENT APPEARANCE.
5. 16" X 16" X 6.62 SJB IN ACCESSIBLE AREA WITHIN 25" OF DOOR MOUNTED NO HIGHER THAN 10' AFF. SJB TO BE HOFFMAN MODEL A16N16ALP C/W HOFFMAN A16N16MPP PERFORATED BACKPLATE, ALT2AR CYLINDER LOCK AND TAMPER SWITCH.

CR	CK	LA	REX	DC	CABLE TYPE
0	1	1	0	1	20/6 18/2 22/2 CAT6A
					2 3 1 2

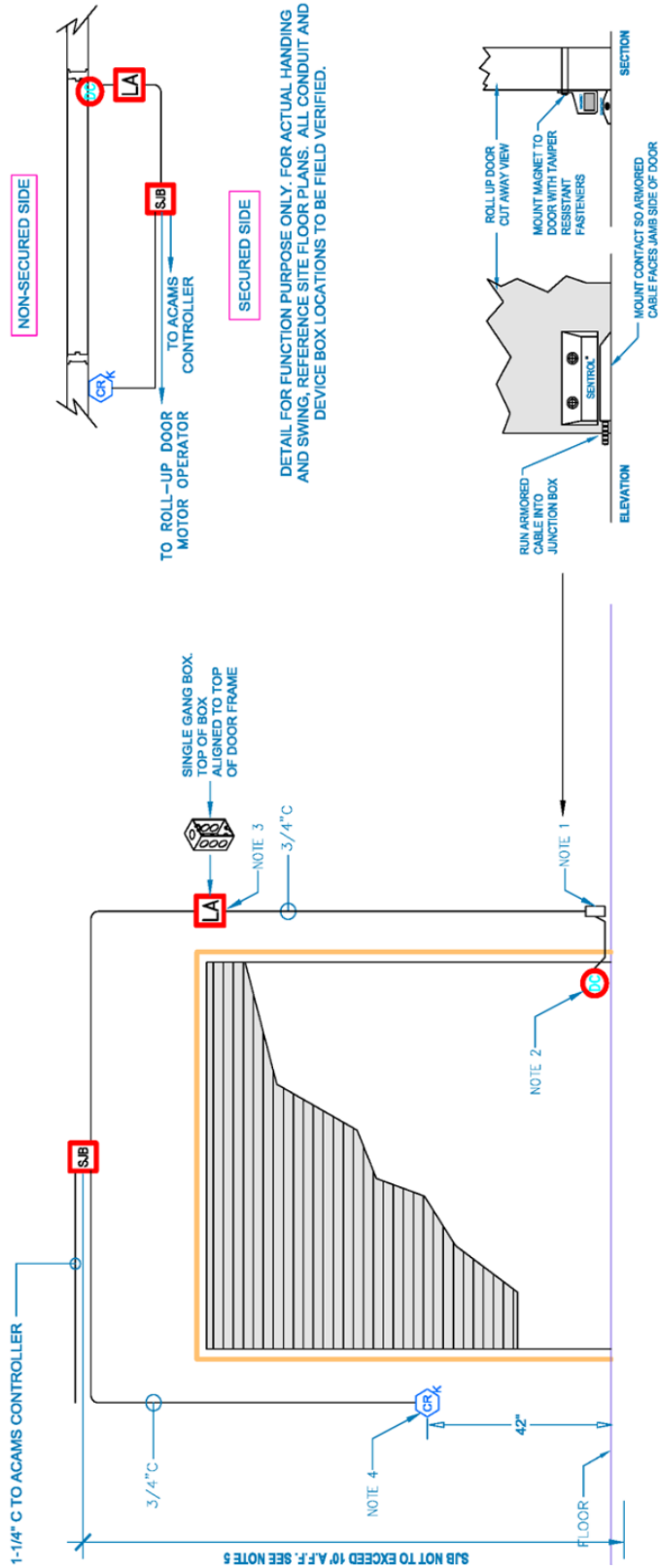

5 ROLL UP DOOR WITH CARD READER KEYPAD
SCALE: NOT TO SCALE

ACAMS infrastructure installation detail for a roll up door with card reader keypad.

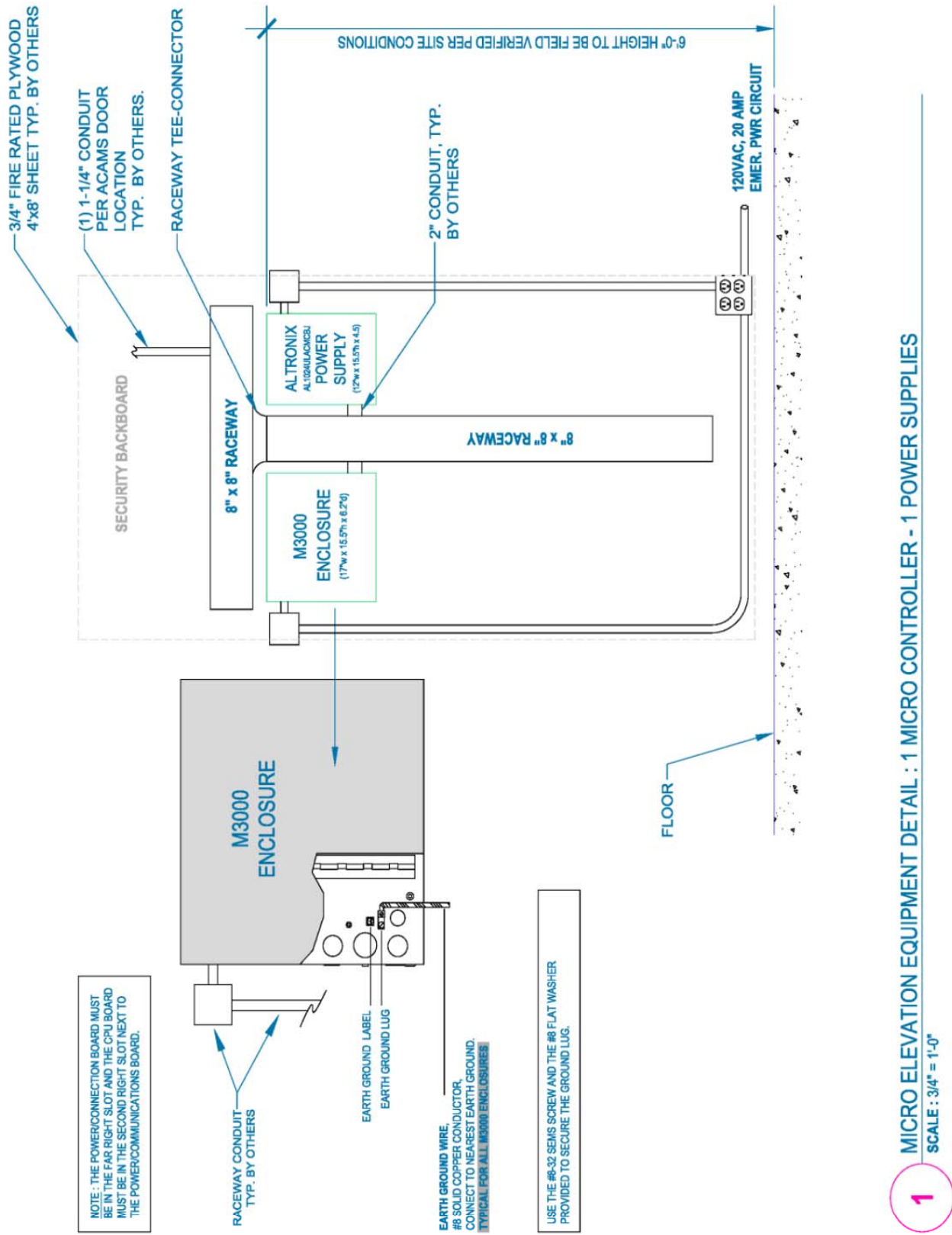

ACAMS infrastructure installation detail for 1 micro controller and 1 power supply.

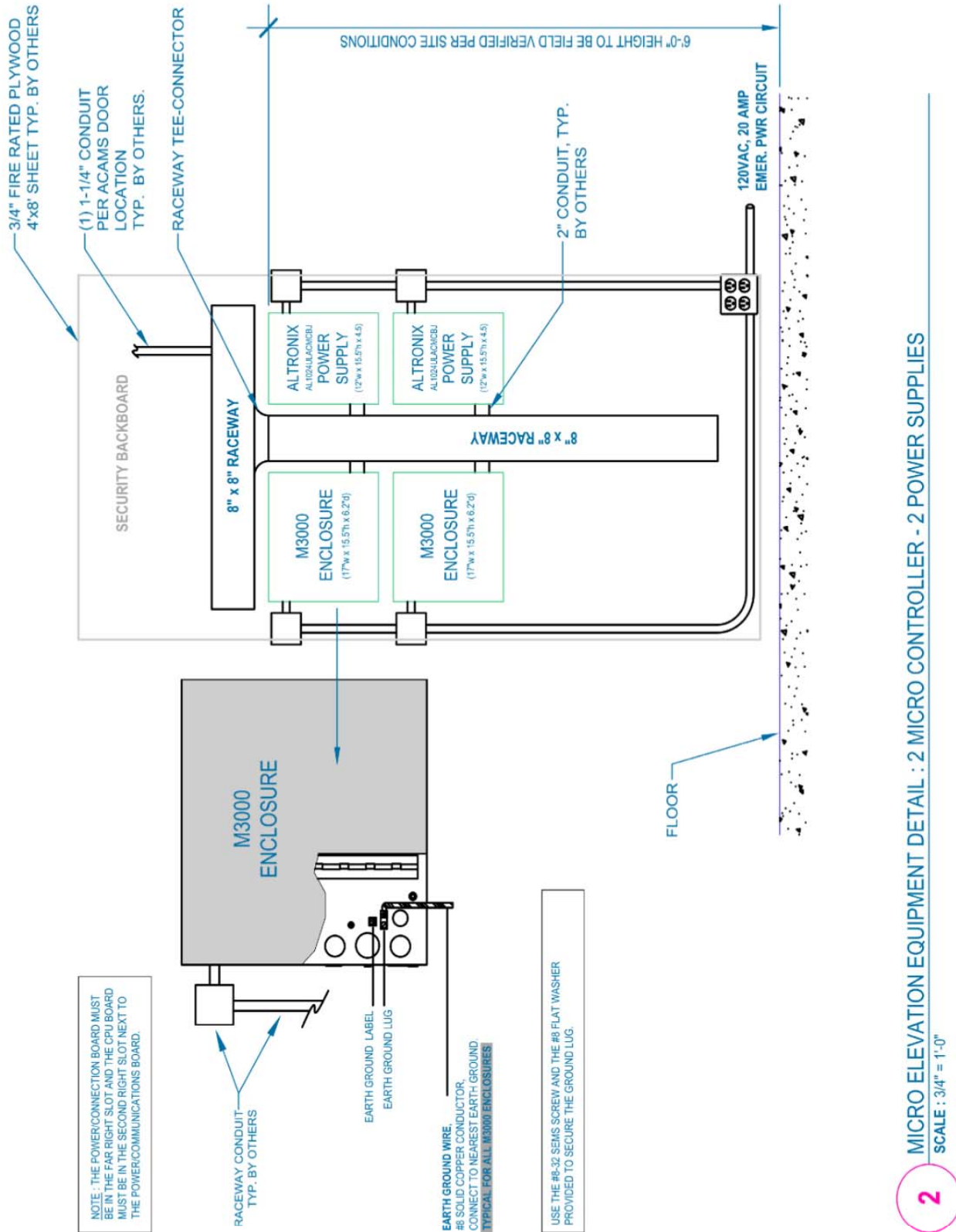

ACAMS infrastructure installation detail for 2 micro controllers and 2 power supplies.

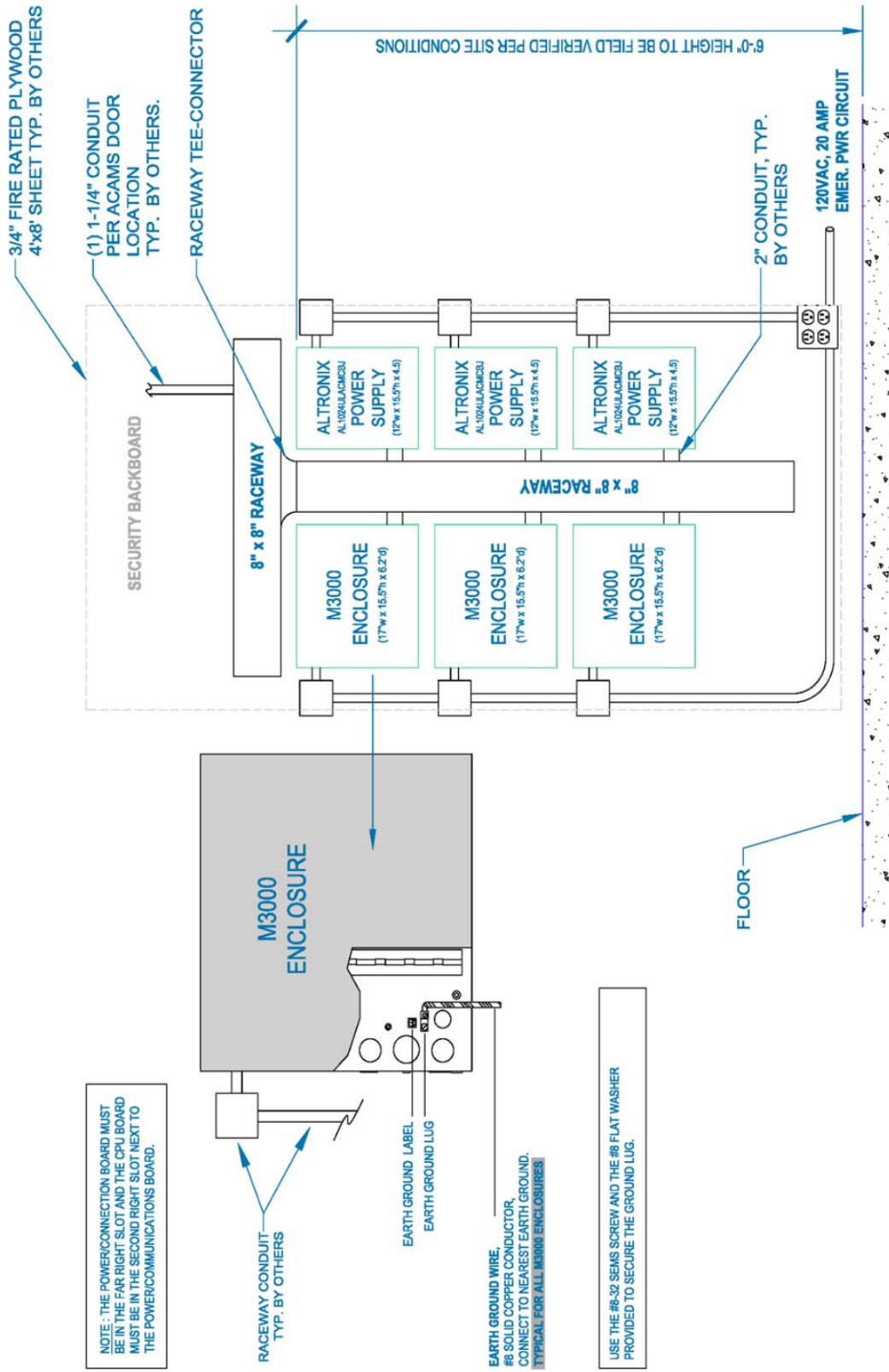

3 MICRO ELEVATION EQUIPMENT DETAIL : 3 MICRO CONTROLLER - 3 POWER SUPPLIES
SCALE : 3/4" = 1'-0"

ACAMS infrastructure installation detail for 3 micro controllers and 3 power supplies.

2.38. L&S > COMMON ELEMENTS > ACCESS POLICY

- 2.38.1. Access to open ACAMS or keyed IT locations can be requested by calling the IT Service Desk at 424-646-9000 at least forty-eight (48) hours in advance. This service provided by LAWA is to open facility doors and not to “baby-sit” Tenants, Contractors, or Service Providers while they do their work.
- 2.38.2. LAWA IT Room access is governed by the policy statement in Vol. 3 Appendix.

2.39. L&S > COMMON ELEMENTS > ACCESS FLOORS

- 2.39.1. IT Rooms shall not have raised access floors unless approved by LAWA.
- 2.39.2. Data Centers may or may not have raised access floors –depending upon the design approved by LAWA.
- 2.39.3. Control Centers may have a low profile 6-inch raised access floor – if the ceiling is at least nine (9) feet high.
- 2.39.4. Floor panels shall be rated at a minimum of 1000 pounds per square inch minimum.
- 2.39.5. The raised floor system shall be grounded.



Grounding is required on raised access floors.

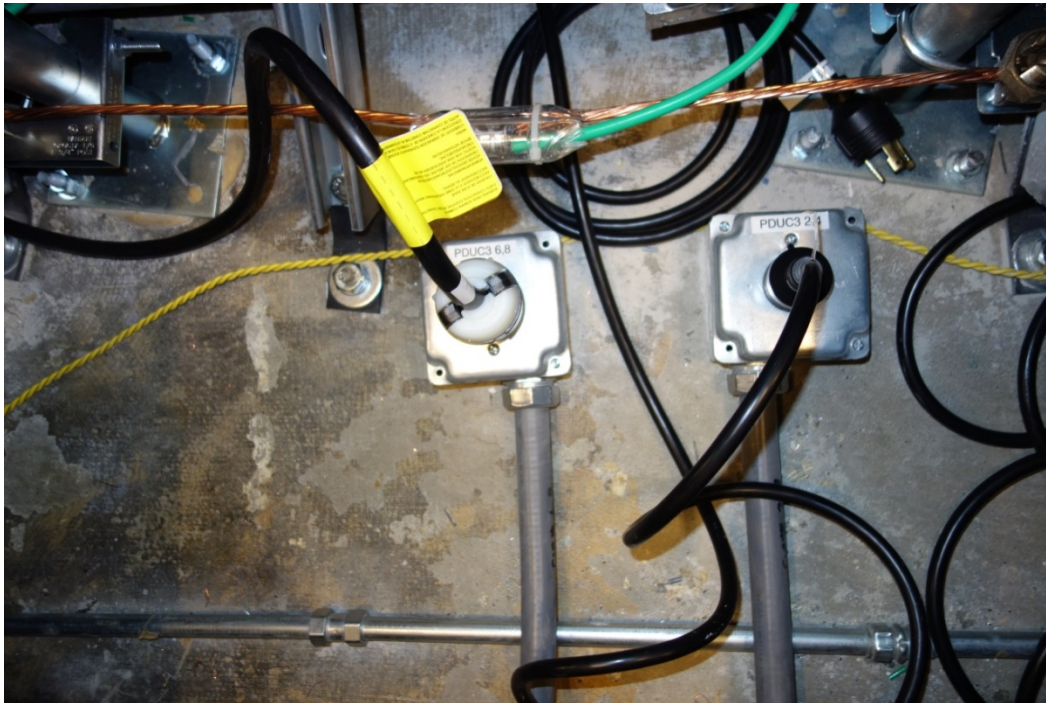

Grounding and electrical circuits shown under a raised access floor.

- 2.39.6. Raised floor shall use fire-resistant grommets (preferably brush type) to pass cables.
- 2.39.7. Underfloor pathway shall use a minimum of 6-inch to 12-inch wire basket or equivalent.

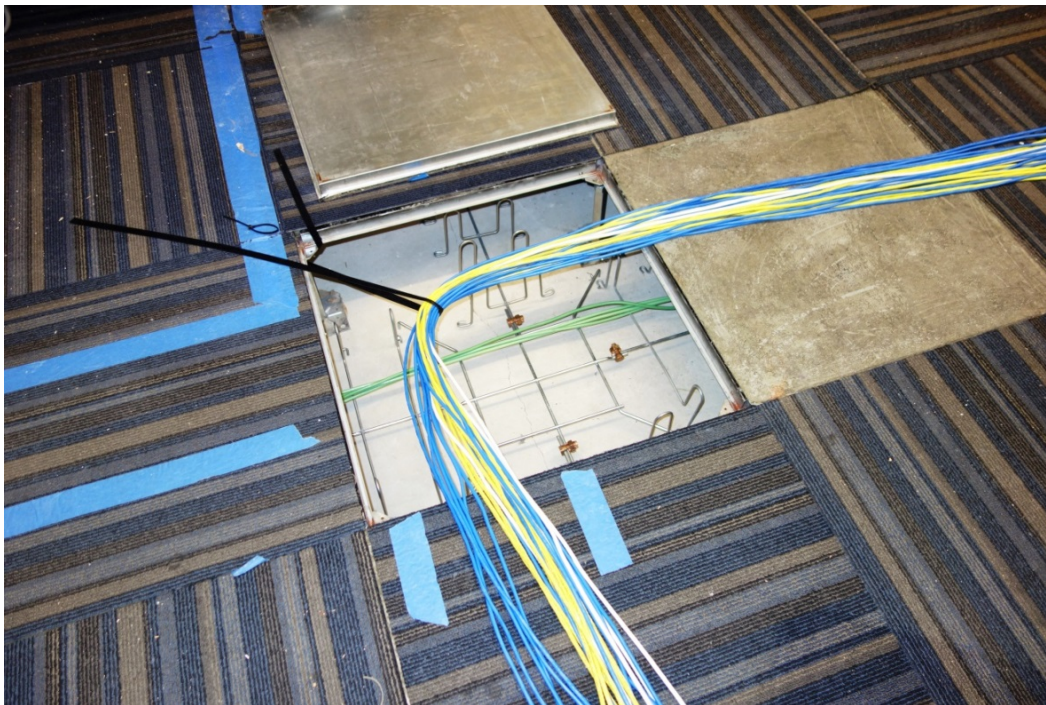

Wire basket shown under an access floor. Cables being measured before installing.

- 2.39.8. Three (3) Tile and/or carpet pullers shall be provided per each IT room that serves the raised floor area.



Access-Floor Puller.

2.40. L&S > COMMON ELEMENTS > CABINETS

- 2.40.1. DAMAC floor-mounted cabinets 34" W x 36" D x 84" H shall be used in all MPOE's and IT Rooms.
- 2.40.2. Floor-mounted cabinets shall have split mesh doors.
- 2.40.3. DAMAC wall-mounted cabinets 22" W x 20" D x 36" H shall be used within TCWC's.
- 2.40.4. Consult LAWA IMTG for equipment cabinet requirements for data centers.
- 2.40.5. Damac floor-mounted cabinets shall be anchored with four (4) 1/2-13" x 4" bolts (minimum size) unless structural calculations require an increase bolt size.
- 2.40.6. Raised-floor-mounted cabinets shall be anchored with four (4) 5/8-11" threaded rod (minimum size) unless structural calculations require an increase. Threaded rods shall have rod stiffeners installed.
- 2.40.7. For IT Room renovation where there is insufficient space, DAMAC cabinets 28" W x 36" D x 84" H shall be used in all MPOE's.

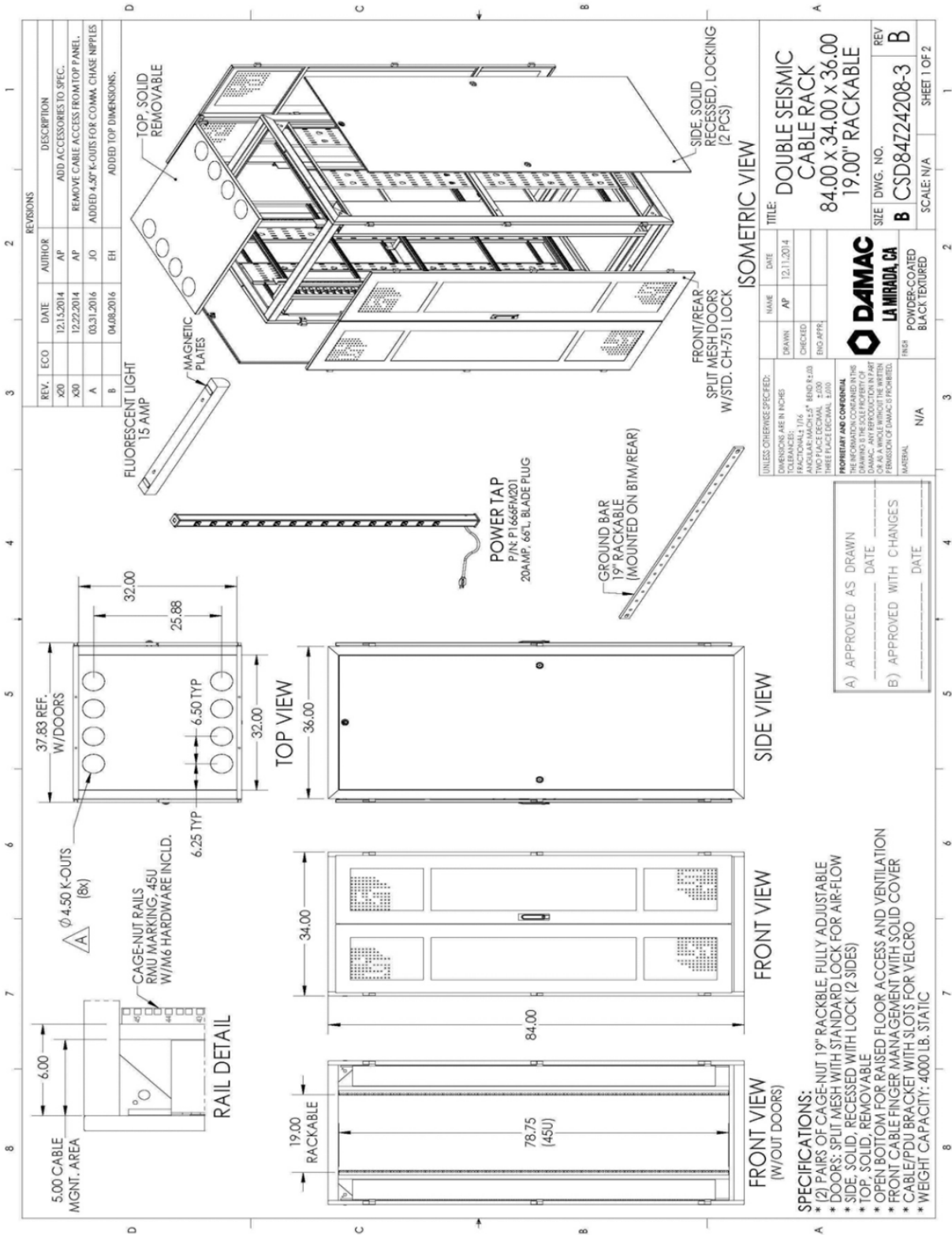

Required 34" x 36" x 84" cabinets to be installed in new construction – Outside view.

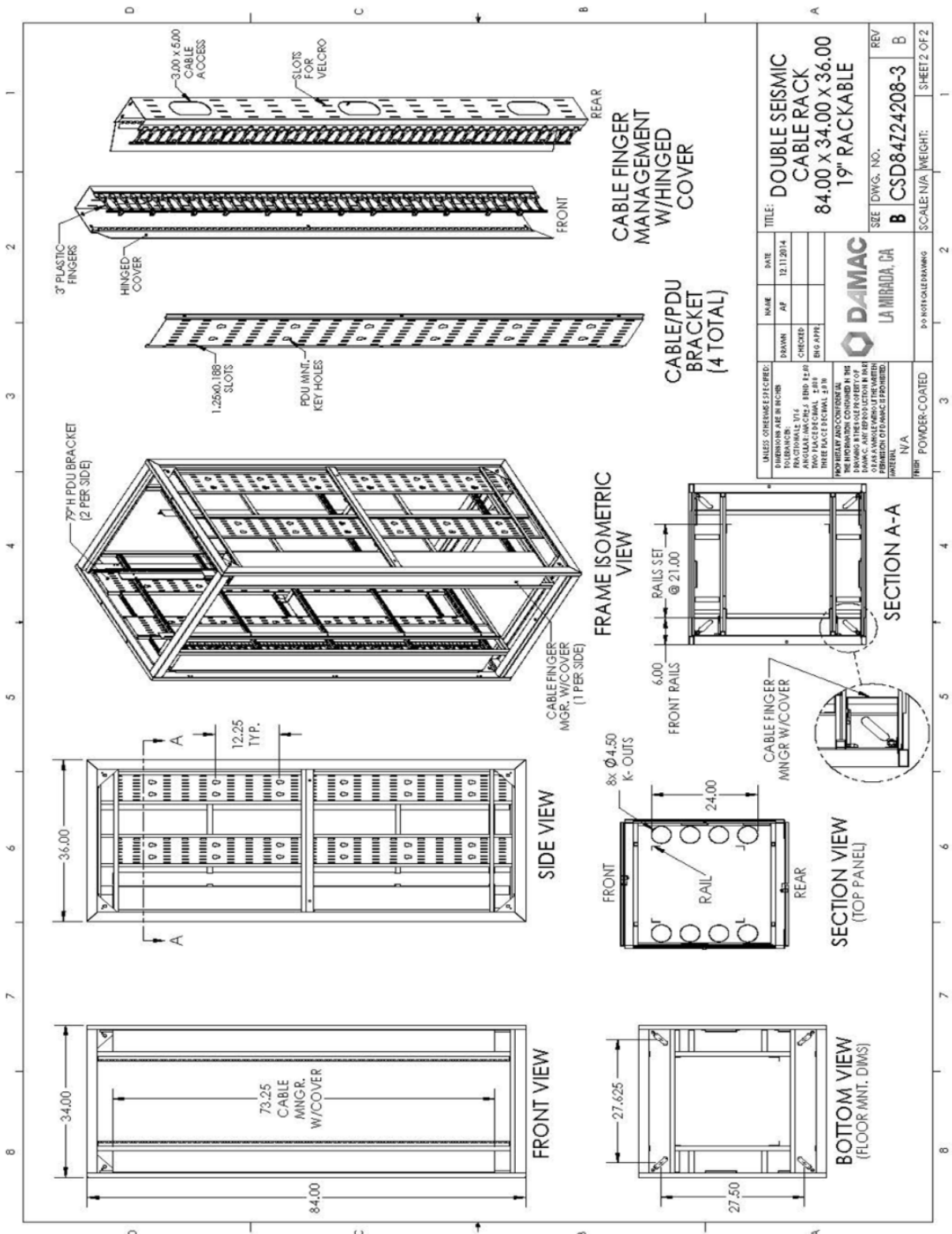

Required 34" x 36" x 84" cabinets to be installed in new construction – Inside view.

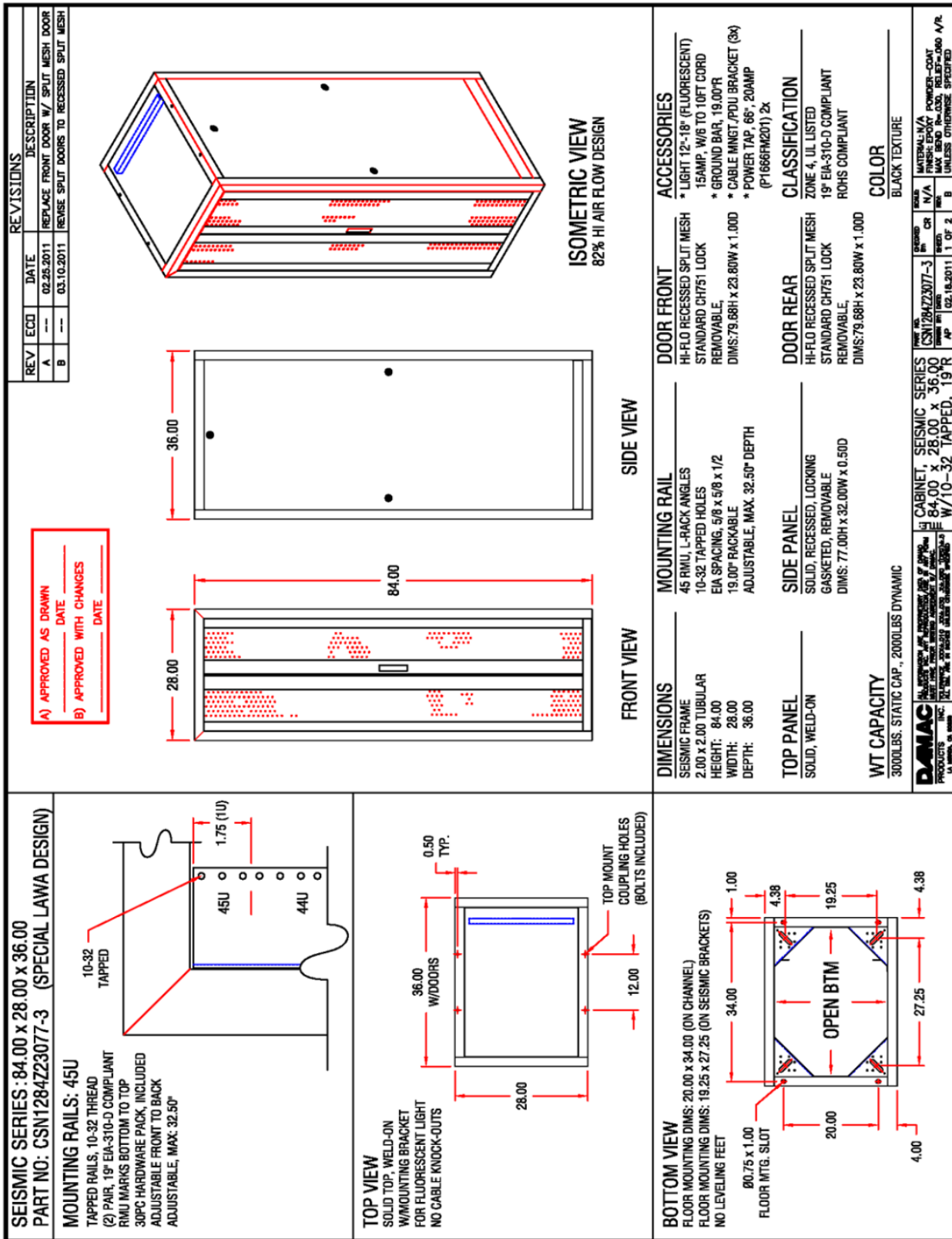

Required 28" x 36" x 84" cabinets to be installed for renovation of existing IT Rooms.

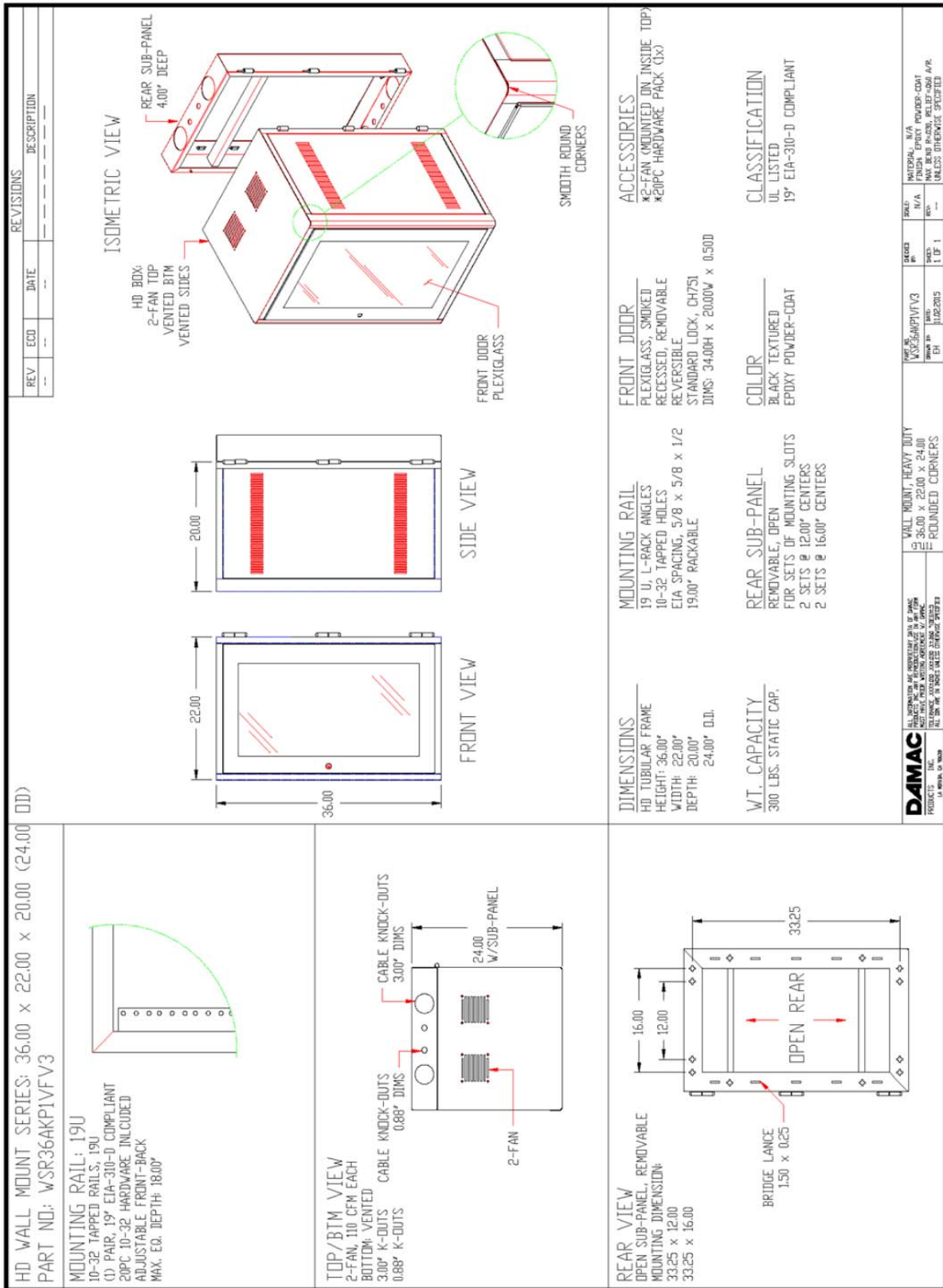

Required 22" x 20" x 36" cabinets to be installed for Tenant Wiring Closets.



Existing IT Room shown with 2 rows of Damac cabinets.



Existing IT Room shown with 1 row of Damac cabinets.

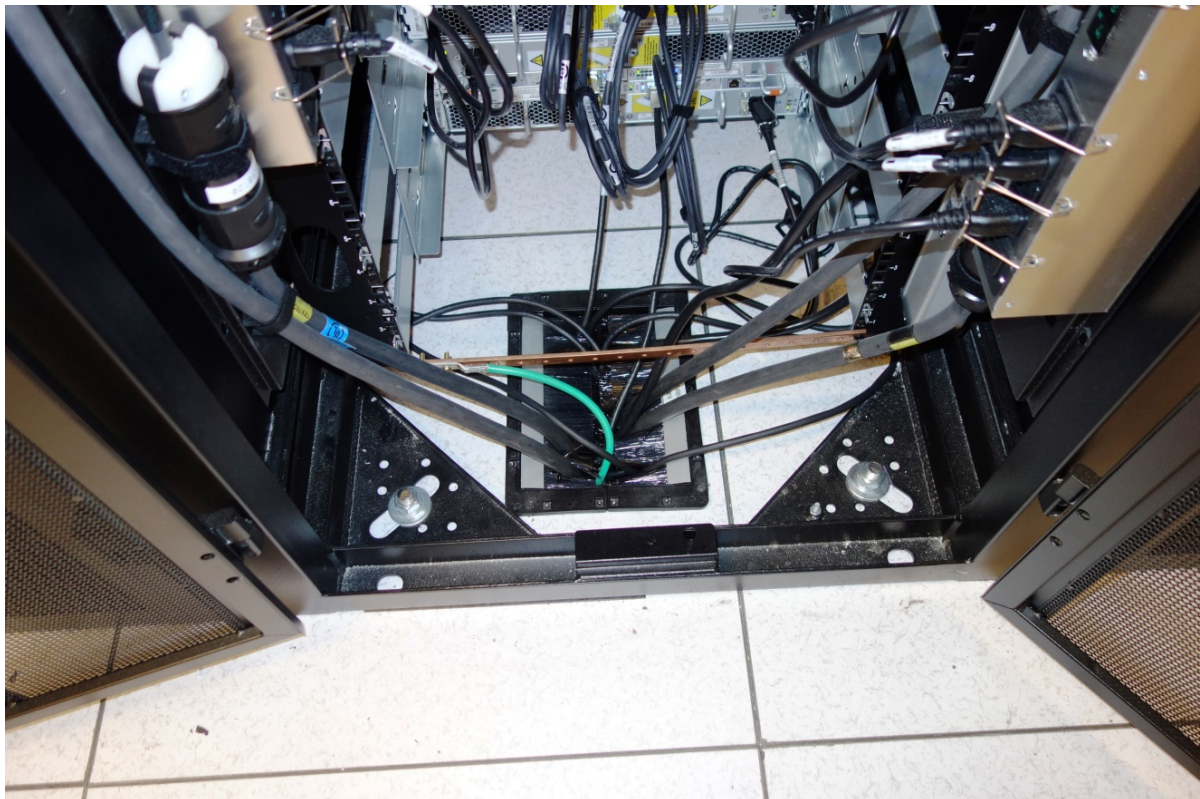

(4)-point equipment cabinet anchoring is shown in a Damac cabinet.

2.41. L&S > COMMON ELEMENTS > CABINETS > CONDUIT

- 2.41.1. Cabinets with conduit and cabling fed from the ceiling shall have knockouts punched on top of the cabinets
- 2.41.2. Roof-fed cabinets with infrastructure from the ceiling shall have knockouts punch in the cabinet roof.
- 2.41.3. Roof-fed electrical conduits shall enter closest to the back of the cabinet near the door hinge.

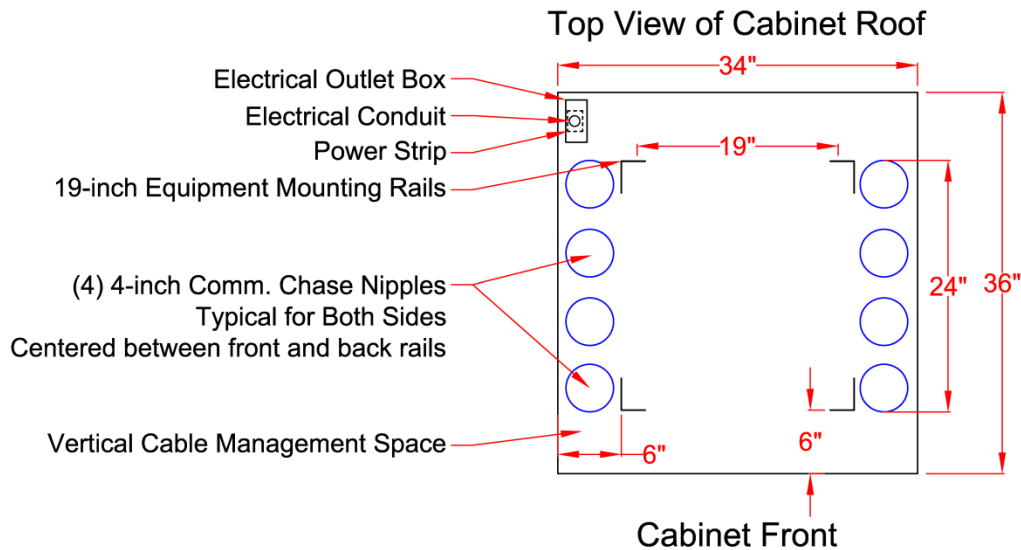

Cabinet roof layout for conduits and cables.

- 2.41.4. Electrical conduit shall be confined to one side and rear of the cabinet.
- 2.41.5. Roof-fed comm. cables into cabinets with either/or fiber and copper patch panels, shall have four (4) 4-inch conduit chase nipples on each side of the cabinet – centered from front to back in the cabinet.
- 2.41.6. All equipment shall be protected in place during knock-out operations.
- 2.41.7. Comm. chase nipples shall be installed towards the cabinet sides in the vertical cable management area.
- 2.41.8. All cabinet roof conduits shall be plugged if empty or firestopped if cables present.

2.42. L&S > COMMON ELEMENTS > CABINETS > ELECTRICAL

- 2.42.1. All IT equipment cabinets and two-post racks shall have at least one dedicated 120V 20A electrical circuit in conduit and one smart Power Distribution Unit (PDU) smart power strip.
- 2.42.2. PDU type and model shall be taken from the list below or Server Technology Inc (STI) equivalents.

Circuit/Receptacle from FDCs	PDU Model
208V 3PH 50A, CS8369	CW-24VDV425A9
208V 3PH 50A, CS8369	CX-24VDV425A9
208V 30A, L6-30	STV-4102C
208V 30A, L6-30	SEV-4102C
208V 3PH 30A, L21-30	CW-30VYM458C2-012
208V 3PH 30A, L21-30	CX-30VYM458C2-012

- 2.42.3. Cabinets that contain high-power active equipment may require an additional 120V 20A dedicated circuit.
- 2.42.4. Each Cabinet that contains a network Premise Equipment (PE) Distribution switch shall have two (2) 208V 30A dedicated electrical outlets or their equivalent as required by the latest technology.
- 2.42.5. Cabinet electrical feeds may enter the cabinet from either the cabinet roof or floor.
- 2.42.6. Cabinet electrical feeds shall be located as far to the rear of the cabinet as is possible and terminate in a 4S box.



Electrical conduits feeding individual cabinets toward cabinet rear.



Orange electrical conduits are shown feeding individual cabinets at cabinet rear.

- 2.42.7. Electrical conduit for should be located on one side of the cabinet.
- 2.42.8. Legacy cabinets were furnished from the manufacturer with two power strips. With these new standards only one power strip shall be installed.
- 2.42.9. Cabinet electrical feed may terminate either near the top or near the bottom of the inside cabinet.
- 2.42.10. Multiple cabinet electrical outlet boxes secured to the side of the cabinet should be installed in one single column and not two adjacent columns – interior cabinet space needs to be conserved.



Cabinet electrical should be on only one side of cabinet rear with only one power strip.



Four outlets on the bottom are ok as shown. Cabinet electrical should be on only one side of cabinet rear. One power strip should have been removed and the conduit placed on the right side.

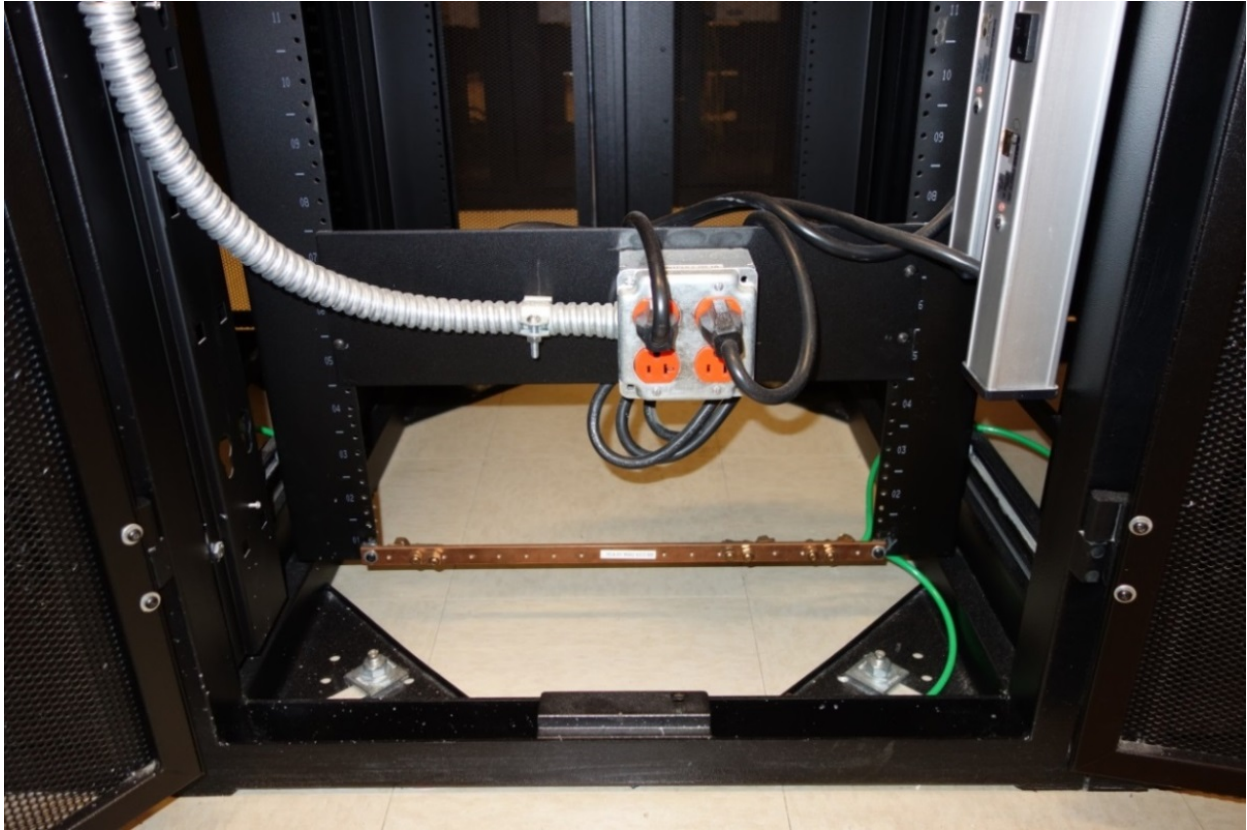

Flex Conduit is towards the back-most part of the cabinet but should have been on the right side. Quad outlet should be on the side. It is acceptable to remove one power strip depending on the calculated number of devices powered.

2.43. L&S > COMMON ELEMENTS > CABINETS > GROUNDING

2.43.1. All cabinets shall have a grounding busbar connected to the TGBB.



Standard equipment cabinet equipment grounding bus bar shown.

2.44. L&S > COMMON ELEMENTS > CABINETS > LIGHTING

- 2.44.1. All full-size IT cabinets shall have light fixtures.
- 2.44.2. Light fixtures shall be mounted either on the top rear or side rear of the cabinet.



Cabinet light fixture can mount on the side to avoid top obstructions.



Cabinet light fixture can mount on the top.



Cabinet light fixture can mount on the top – different fixture.

2.45. L&S > COMMON ELEMENTS > CEILINGS

- 2.45.1. IT Room ceilings shall be open without any acoustical coatings that can slough over time.



New construction showing a 14'+ open ceiling for easy access to conduit.

- 2.45.2. Minimum ceiling height is nine (9) feet, preferably fourteen (14+) feet.
- 2.45.3. Minimum ceiling height for IT Rooms to for renovated areas shall be eight feet, six inches, (8' 6").

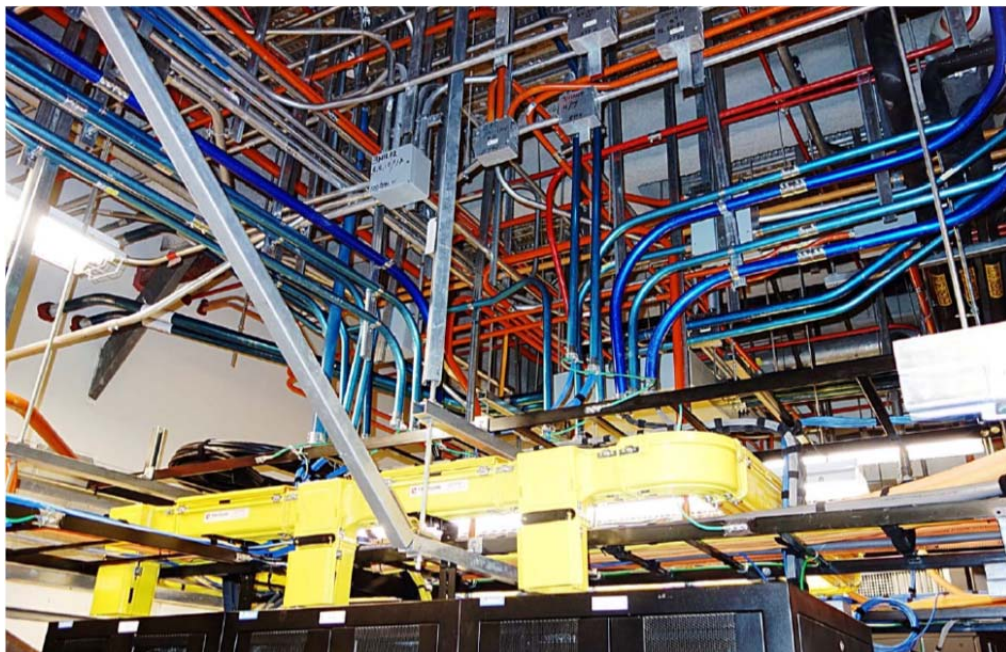

New construction showing a 14' open ceiling for easy access.

- 2.45.4. Drop (hard lid) or suspended ceilings are not permitted.



Legacy IT Room showing 8' 6" hard lid ceiling and cramped space.

- 2.45.5. Conduits should be run in straight lines to limit the number of bends around ceiling obstructions. Straight conduit lines extends the cabling reach from each IT Room and MPOE.



Ceiling obstructions can interfere with the pathways from IT Rooms.



Another sample of ceiling obstructions.

2.46. L&S > COMMON ELEMENTS > DIVIDERS

- 2.46.1. Dividers shall be installed between the LAWA IT room, the Service Provider space, and the Tenant Wiring Closet (TCWC).

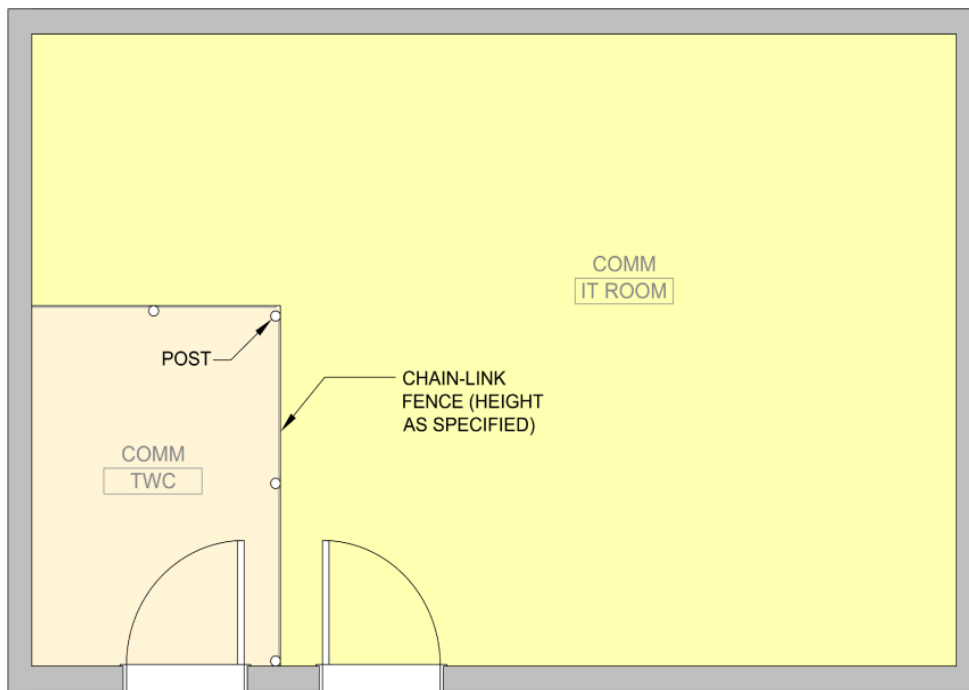

One of multiple possible configurations for TCWC's adjacent to IT rooms.



Chain link divider separating TCWC adjacent to an IT Room. Camera is the facing entrance foyer.

- 2.46.2. Dividers can be walls or vinyl-coated chain link.
- 2.46.3. Dividers shall wrap around (enclose) conduit and cable tray penetrations through adjacent rooms.



Divider wall enclosing ladder rack.



Divider wall enclosing light fixtures and ladder rack.

2.47. L&S > COMMON ELEMENTS > DOORS

- 2.47.1. IT rooms and doors shall be rated a minimum of 1-hour fire protection. Doors shall have the fire rating affixed to the inside frame for inspection.



Fire protection stamp located in the inside frame of the door.

- 2.47.2. IT room doors shall seal so that outside air, dust, and dirt cannot get into the IT Room/MPOE with the door closed.
- 2.47.3. Doors shall be a minimum of 36" x 80" and Service Provider doors 72" x 80".

2.48. L&S > COMMON ELEMENTS > ELECTRICAL

- 2.48.1. Electrical panels shall be fully populated with Arc Fault Circuit Interrupter (AFCI) circuit breakers – one for normal power and one for UPS power.



Fully populated breaker panels are required.

- 2.48.2. Electrical panels shall have identification legends that are printer or labeler generated – not hand written. Legend shall include the panel identification and phase and voltage ratings.

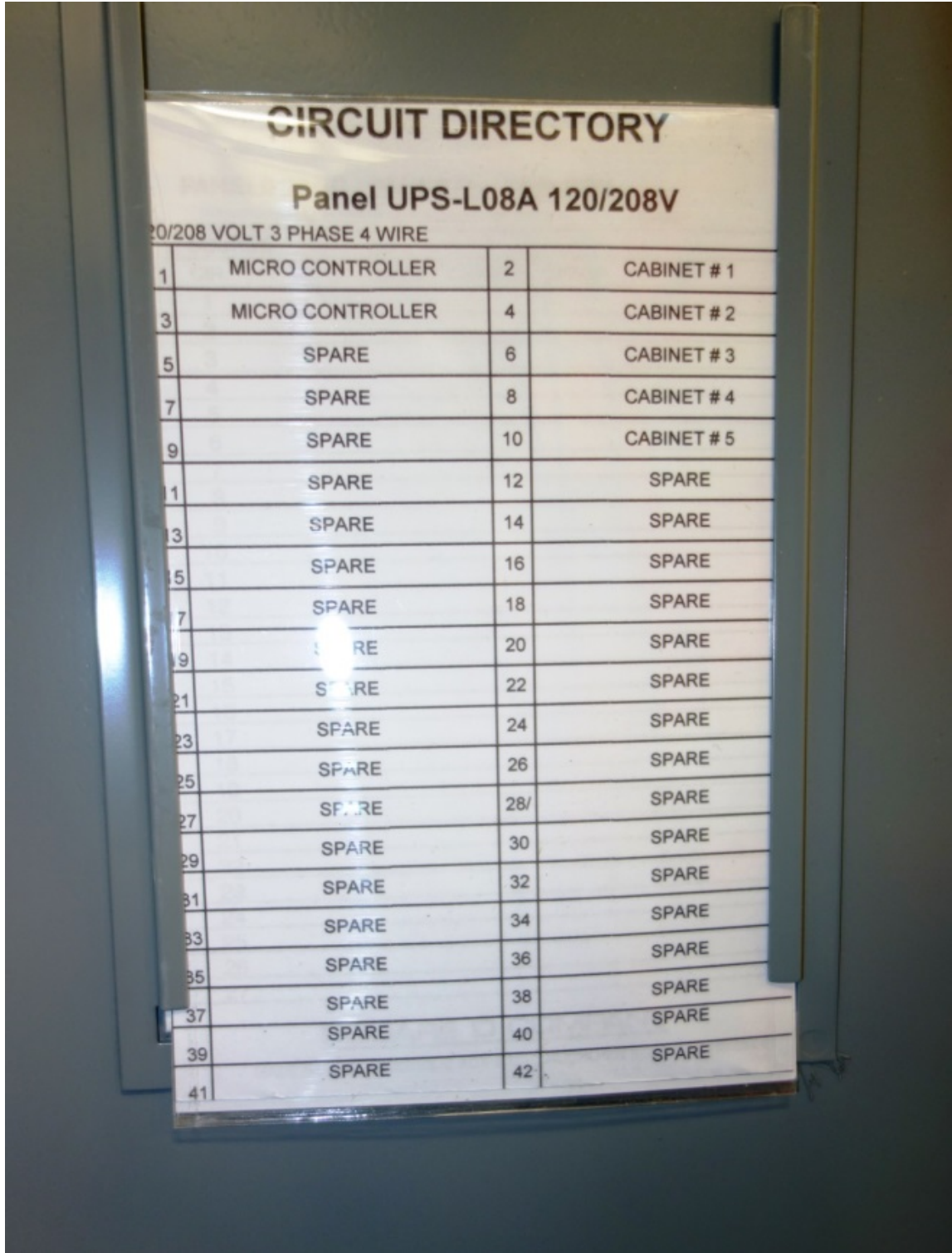

Computer generated electrical panel legends are required.

- 2.48.3. Electrical bus ducts are not permitted to be installed within or above IT Rooms.
- 2.48.4. Equipment cabinets shall be wired for UPS power for 120V and 208V as required after a needs assessment.
- 2.48.5. All electric panels shall be labeled according to the LAWA Design & Construction handbook Division 26 Section 05 04 - Identification for Electrical Systems, located at. <http://www.lawa.org/laxdev/Handbook.aspx>



Electric panel and conduits shall be labeled per the LAWA D&CH.

- 2.48.6. All electric panel conduits shall be labeled within 12-inches of termination point into panels and junction boxes.

2.49. L&S > COMMON ELEMENTS > ELECTROMAGNETIC RADIATION

- 2.49.1. IT Rooms, MPOE's and spaces shall be located away from sources and potential sources of ElectroMagnetic Interference (EMI).
- 2.49.2. If separation from EMI sources is not possible, then IT Rooms and spaces shall be tested and documented by a LAWA-approved independent 3rd party for the presence, amplitude, and likely interference of low, high, and radio frequencies.
- 2.49.3. EMI Sources shall be shielded if feasible. Otherwise, the walls, ceilings, floors, and doors of the MPOE shall be shielded using MU-copper (permeable) foil or equivalent Faraday cage type shielding. Proper shielding shall result in decreasing the amplitude of the frequencies to a level of non-interference.
- 2.49.4. A LAWA-approved independent 3rd party shall review test results and recommend the proper EMI-blocking material.

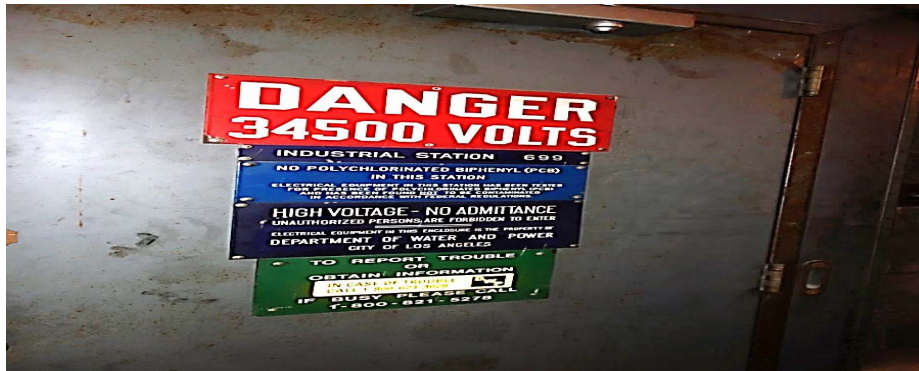

Electrical switchgear rooms are sources of EMI.

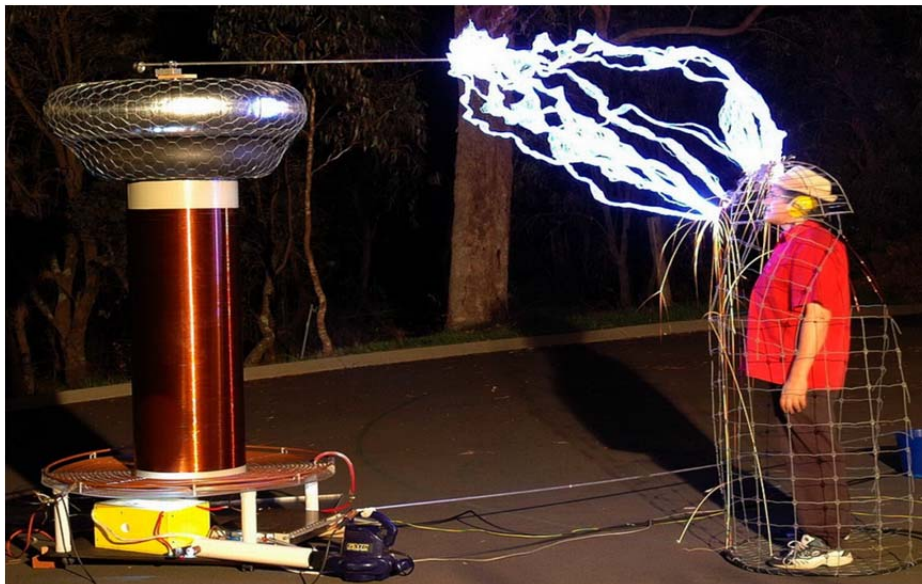

EMI shielding protects from interference.

Source: http://www.thedailysheep.com/what-is-a-faraday-cage_082014/faraday-cage

2.50. L&S > COMMON ELEMENTS > ENVIRONMENTAL MONITORING

- 2.50.1. All IT Rooms shall have environmental monitoring.
- 2.50.2. Netbotz system shall monitor temperature and humidity.
- 2.50.3. Netbotz system shall have water alarms for the MPOE/IT Room floors.



Sample Netbotz floor-mounted flooding sensor.

2.51. L&S > COMMON ELEMENTS > EQUIPMENT RACKS

- 2.51.1. Equipment racks are allowed only for special purposes – like main and intermediate distribution frames and for small room network points-of – presence.



A rack for main distribution frame (MDF) expansion.

2.51.2. Obtain LAWA approval for proposed racks.



Permission obtained for this rack in a small room – front view.



Permission obtained for this rack in a small room – back view.

2.52. L&S > COMMON ELEMENTS > FIRE PROTECTION

- 2.52.1. All IT Rooms shall have fire protection including:
- Smoke detectors
 - Sprinkler heads
 - Pre-action sprinkler system
 - Annunciator
- 2.52.2. IT rooms shall have double-interlock pre-action fire protection sprinkler systems.
- 2.52.3. Pre-action valves, controls, etc., shall be outside of MPOE and IT Rooms.
- 2.52.4. Doors shall be 1-hour fire rated and be a minimum of 36" x 80".
- 2.52.5. IT Room fire protection shall connect to LAWA's Central Utility Plant.

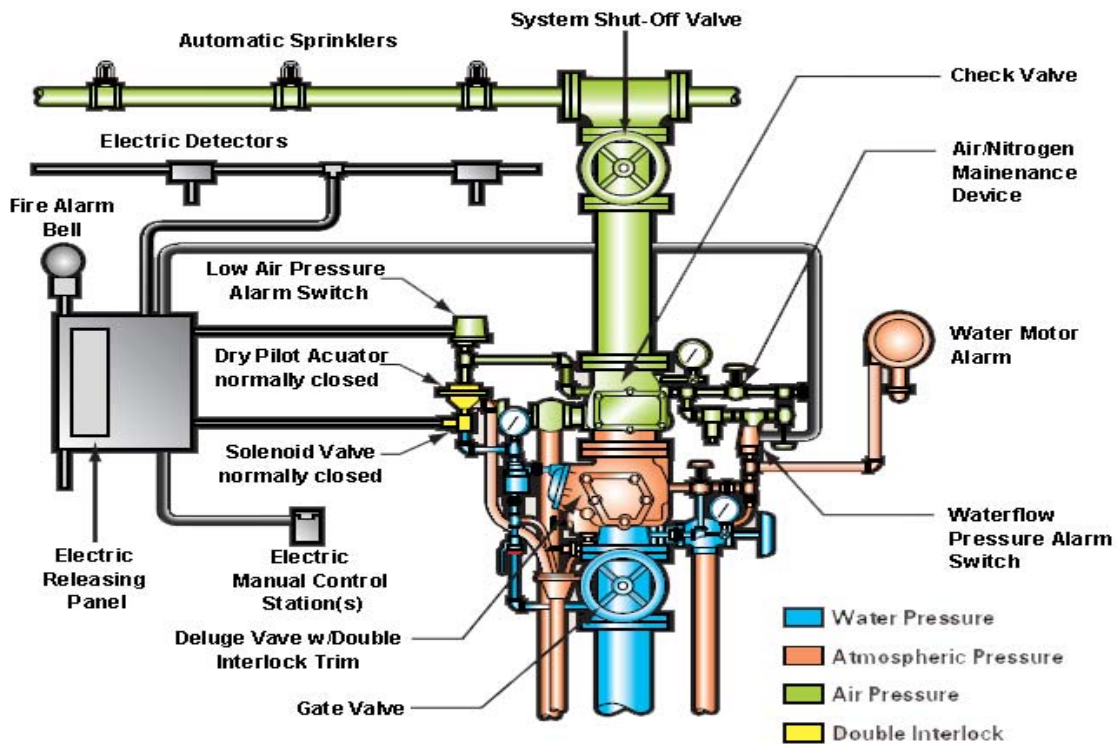

Double Interlock Pre-action system colored diagram.

Courtesy – www.TheCodeCoach.com.

B. Fire Condition (Double Interlock System):

In a fire condition, operation of the detection system activates the first initiating circuit in the release control panel, causing an alarm to activate. When a sprinkler operates, air pressure escapes from the sprinkler piping. The air supervisory switch activates the second initiating circuit in release control panel. When BOTH initiating circuits have been activated, the release control panel energizes solenoid valve open. With the solenoid valve open, prime water is drained from the prime chamber, causing the G-6000P Valve to open, filling the sprinkler piping with water. Water from the intermediate chamber of the G-6000P Valve pressurizes the sensing end of the PORV causing the PORV to open. The open PORV prevents water pressure from building in the prime chamber should the solenoid close.

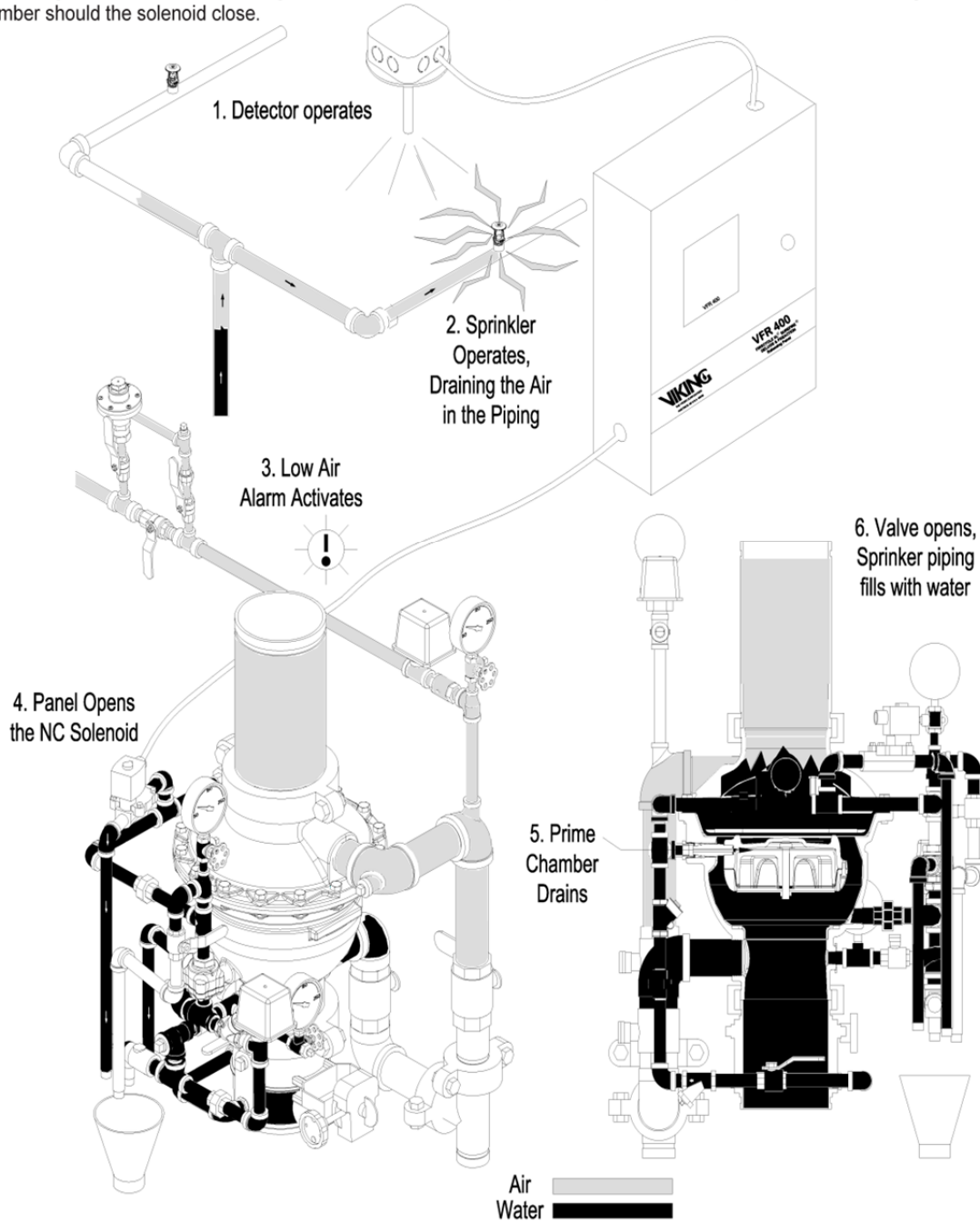

Figure 7b - Fire Condition - Double Interlock System

Pre-action steps during a fire alarm activation. Courtesy - www.VikingGroupInc.com.



Sample IT Room sprinkler heads.



Sample IT Room smoke detector.



Sample fire alarm annunciator panel.

2.53. L&S > COMMON ELEMENTS > FLOORS

- 2.53.1. IT Room floors shall have anti-static tile glued to the sub-floor.
- 2.53.2. Floor tile shall be bonded to the telecommunications grounding system per the manufacturer's requirements.



Copper bonding strap shown from floor tile to grounding bus bar.

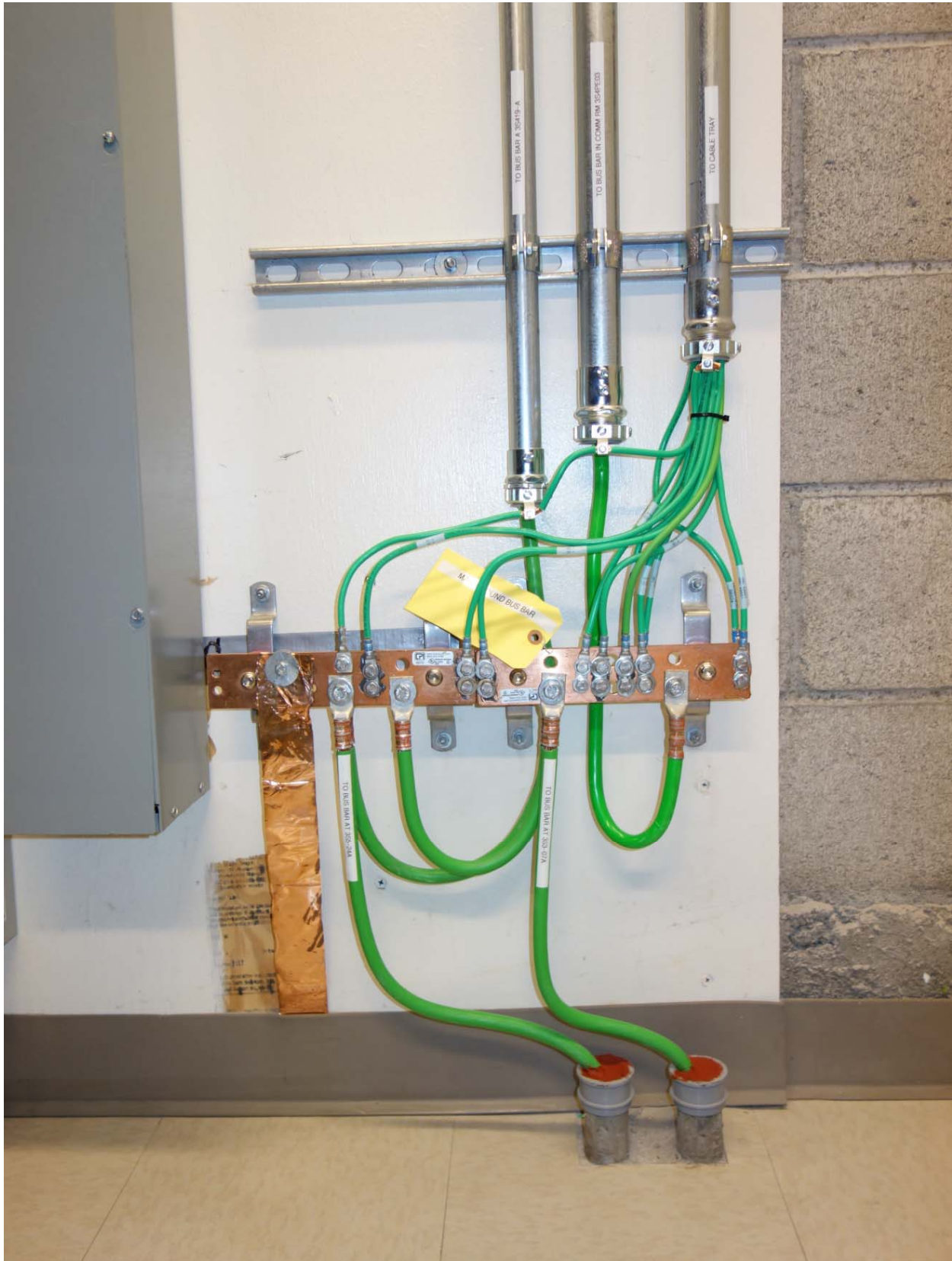

A different IT Room showing anti-static floor tile bonded to a TMGB.

- 2.53.3. Floor tile shall completely cover the room.
- 2.53.4. Floor tile color shall be a light white or gray-speckled or light marbled tan or grey.
- 2.53.5. Bare concrete is not allowed.
- 2.53.6. Carpet is not allowed.
- 2.53.7. Vinyl cove molding shall be installed and glued around the perimeter of the room – regardless of the wall composition.
- 2.53.8. For renovations where cabinets and equipment cannot be moved new tile shall be installed by laying tile around and touching the cabinet bases to look as-if the tile was installed under the cabinets.
- 2.53.9. For renovations where empty cabinets can be moved, new tile shall be installed by removing the cabinets first, then reinstalling and seismically anchoring cabinets.

2.54. L&S > COMMON ELEMENTS > GROUNDING FOR NEW FACILITIES

- 2.54.1. The purpose of telecommunications grounding is to dissipate stray Alternating Currents (AC), electrostatic discharge currents, and lightning strike currents. This is accomplished by bonding to the AC grounding electrode system.
- 2.54.2. All IT Rooms and MPOE's and their associated pathways shall be grounded in accordance with NEC, ANSI/TIA, and BICSI standards and methodologies.
- 2.54.3. For new facilities, designs shall comply with the following diagram.

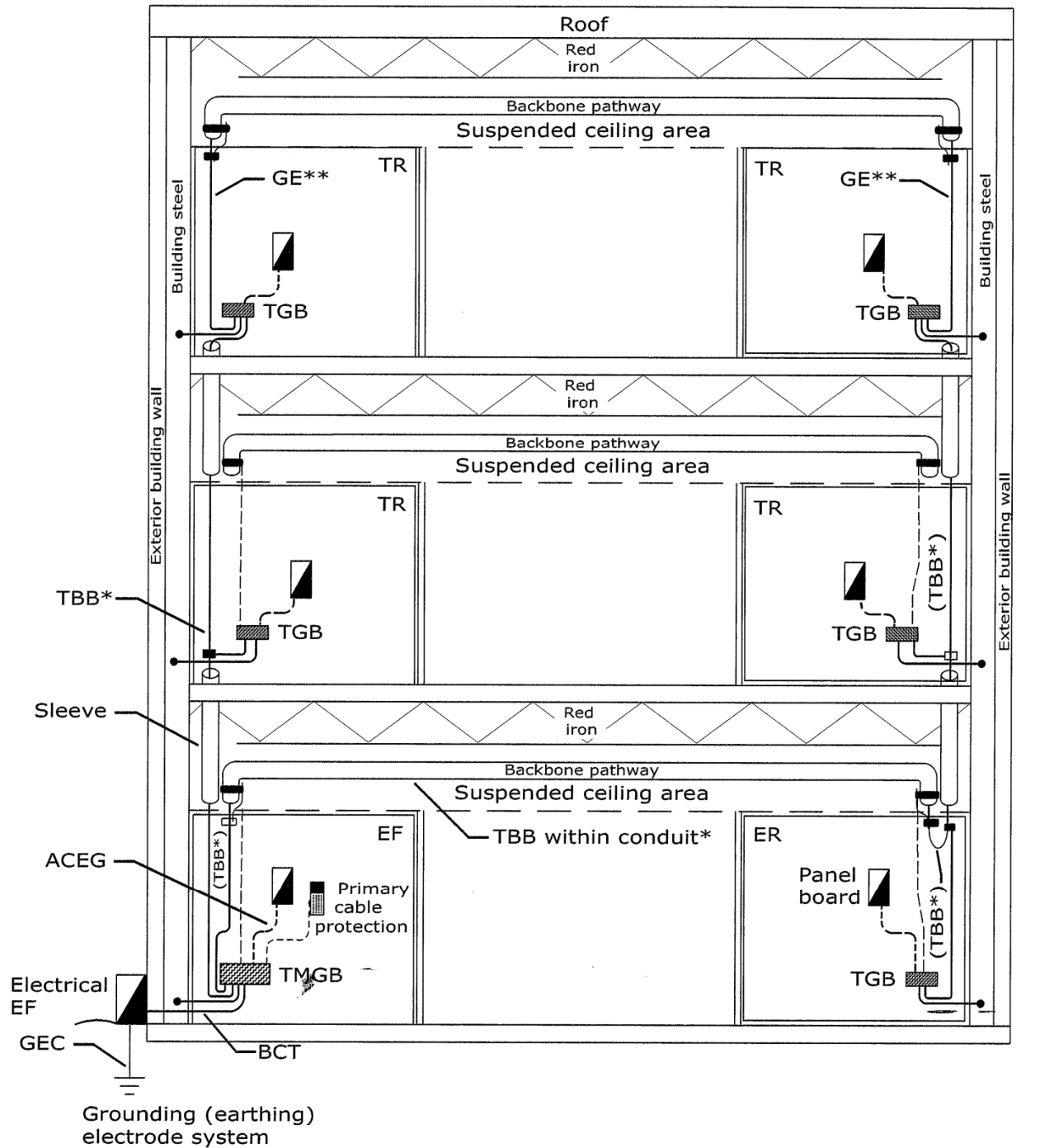

* May be optional installation. See section labeled Telecommunications Bonding Backbone in this chapter for alternative design arrangements.

** May be optional installation. See section labeled Grounding Equalizer in this chapter for alternative design arrangements.

- ACEG = Alternating current equipment ground
- BCT = Bonding conductor for telecommunications
- EF = Entrance facility
- ER = Equipment room
- GE = Grounding equalizer
- GEC = Grounding electrode conductor
- TBB = Telecommunications bonding backbone
- TGB = Telecommunications grounding busbar
- TMGB = Telecommunications main grounding busbar
- TR = Telecommunications room

Telecommunications grounding shall comply with this diagram.
Source: BICSI Telecommunications Distribution Methods Manual – 13th Edition.

2.54.4. For new facilities, grounding conductor sizes shall comply with the following chart.

<u>Between</u>	<u>and</u>	<u>Use</u>
1 ft.	20 ft.	4 AWG
20 ft.	26 ft.	3 AWG
26 ft.	33 ft.	2 AWG
33 ft.	44 ft.	1 AWG
44 ft.	52 ft.	1/0 AWG
52 ft.	66 ft.	2/0 AWG
66 ft.	84 ft.	3/0 AWG
84 ft.	105 ft.	4/0 AWG
105 ft.	125 ft.	250 kcmil
125 ft.	150 ft.	300 kcmil
150 ft.	175 ft.	350 kcmil
175 ft.	250 ft.	500 kcmil
250 ft.	300 ft.	600 kcmil
300 ft.	greater	750 kcmil

2.54.5. All grounding wires shall be:

- Copper
- Stranded
- Insulated
- Green colored
- Protected in conduit

- 2.54.6. MPOE busbars shall be sized a minimum of 4" x 24" x 1/4-inch thick and have sufficient pre-drilled holes for thirty (30) standard-sized 2-hole compression lugs.

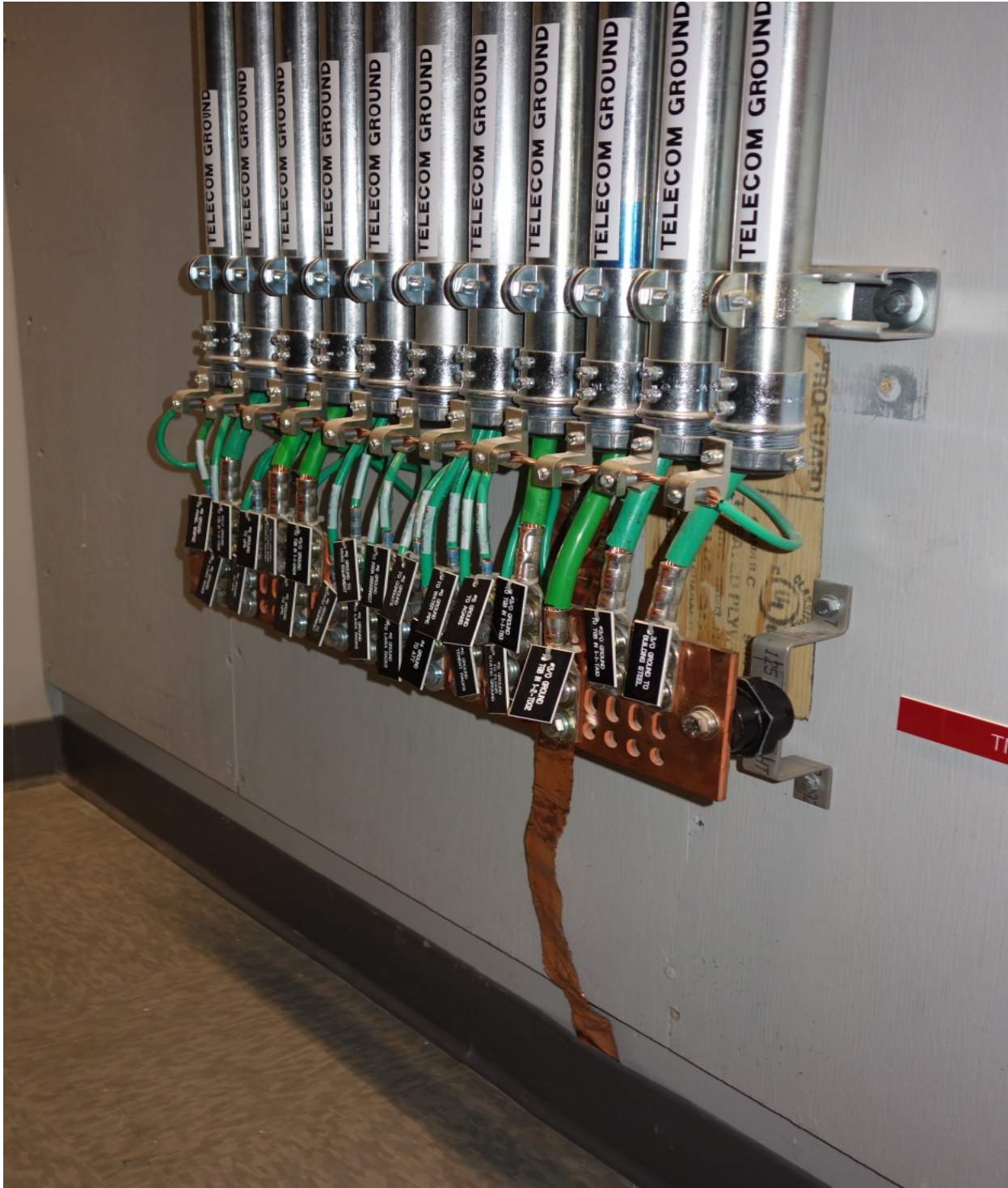

MPOE – Telecommunications Main Grounding Bus Bar (TMGB)

- 2.54.7. IT Room grounding busbars shall be sized at a minimum of 2" x 18" x 1/4-inch thick and have sufficient pre-drilled holes for fifteen (15) standard-sized 2-hole compression lugs.

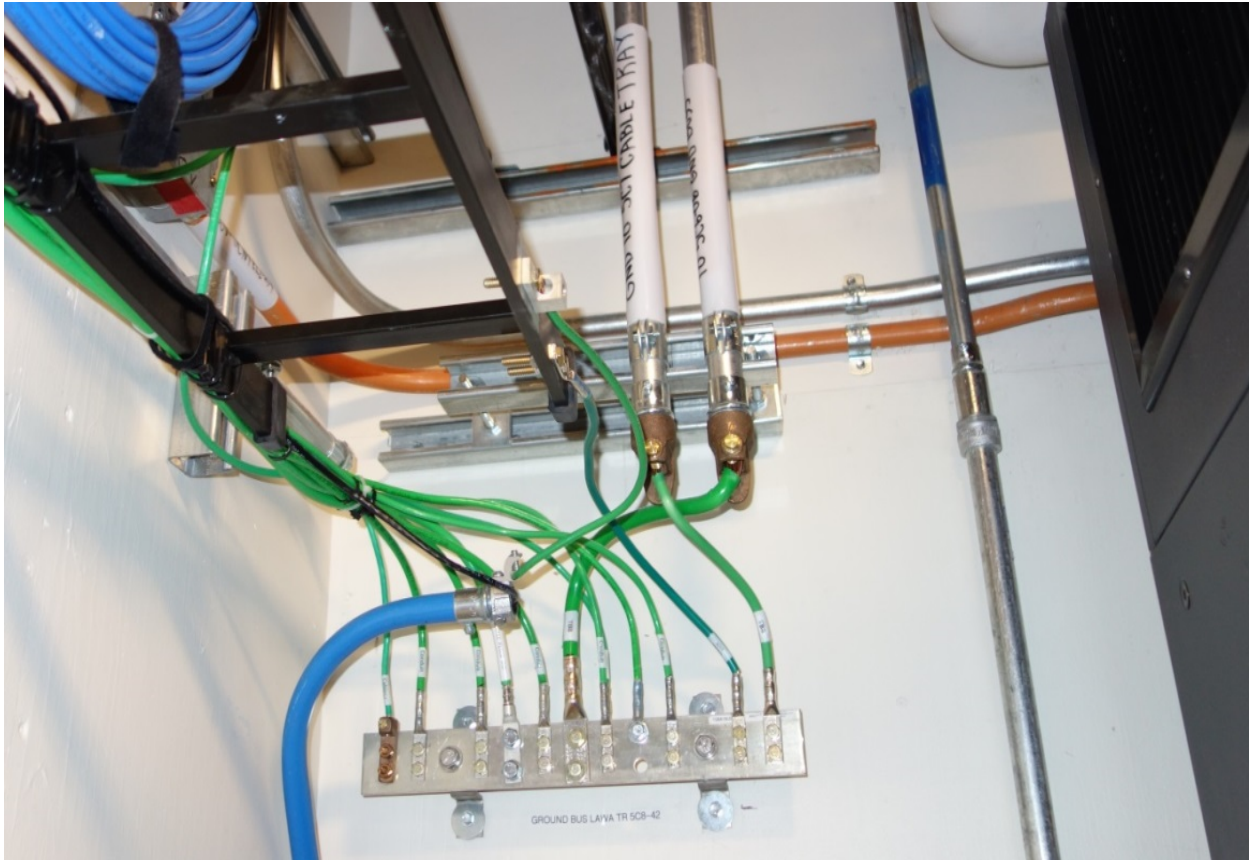

Typical IT Room Telecommunications Grounding Bus Bar (TGB).

- 2.54.8. Bus bars shall be wall-mounted and located at cable tray level height (8' 6") or eighteen (18) inches Above Finished Floor (AFF).
- 2.54.9. All equipment racks and cabinets shall connect to the TGB or TMGB through a Telecommunications Equipment Bonding Conductor that provides a common pathway to the busbar.
- 2.54.10. Grounding busbars shall be listed with a nationally recognized testing laboratory.
- 2.54.11. Grounding busbar surfaces shall be cleaned with a scrubbing pad prior to lug attachment, and covered with an anti-oxidant cream between the grounding lug and the busbar to decrease corrosion.
- 2.54.12. All grounding conductors shall be attached with 2-hole long-barrel compression lugs and have a 2-crimp minimum.
- 2.54.13. Grounding conductors may have exothermic welded joined segments but shall not have any splices.

2.55. L&S > COMMON ELEMENTS > GROUNDING EXISTING FACILITIES

2.55.1. Existing facility grounding designs shall comply with the following diagram.

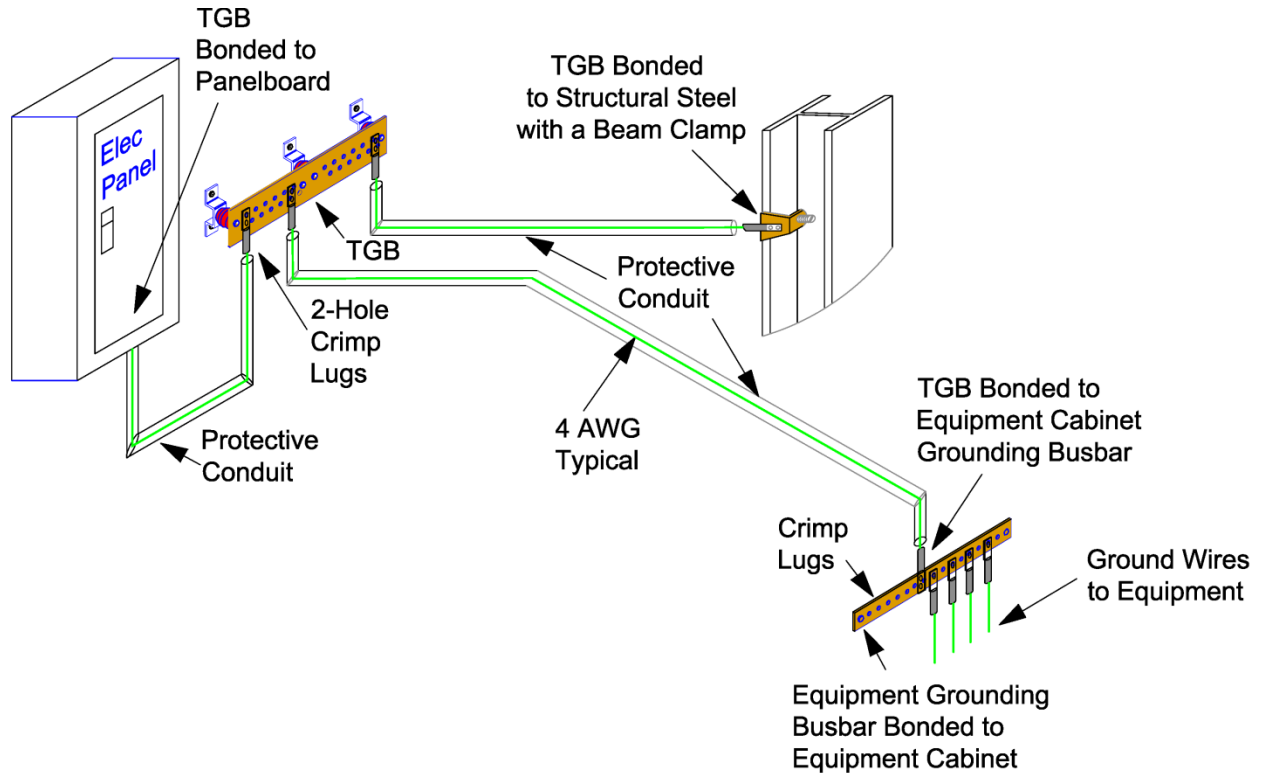

For grounding cable lengths less than 100 ft. and no TBB and no TBGEC required.

2.55.2. All grounding wires shall be:

- 4 AWG copper
- Stranded
- Insulated
- Green colored
- Protected in conduit

2.55.3. Individual Equipment cabinet and rack busbars shall pigtail off the Telecommunications Equipment Bonding Conductor (TEBC) and shall not have their grounding cables daisy-chained from cabinet-to-cabinet.

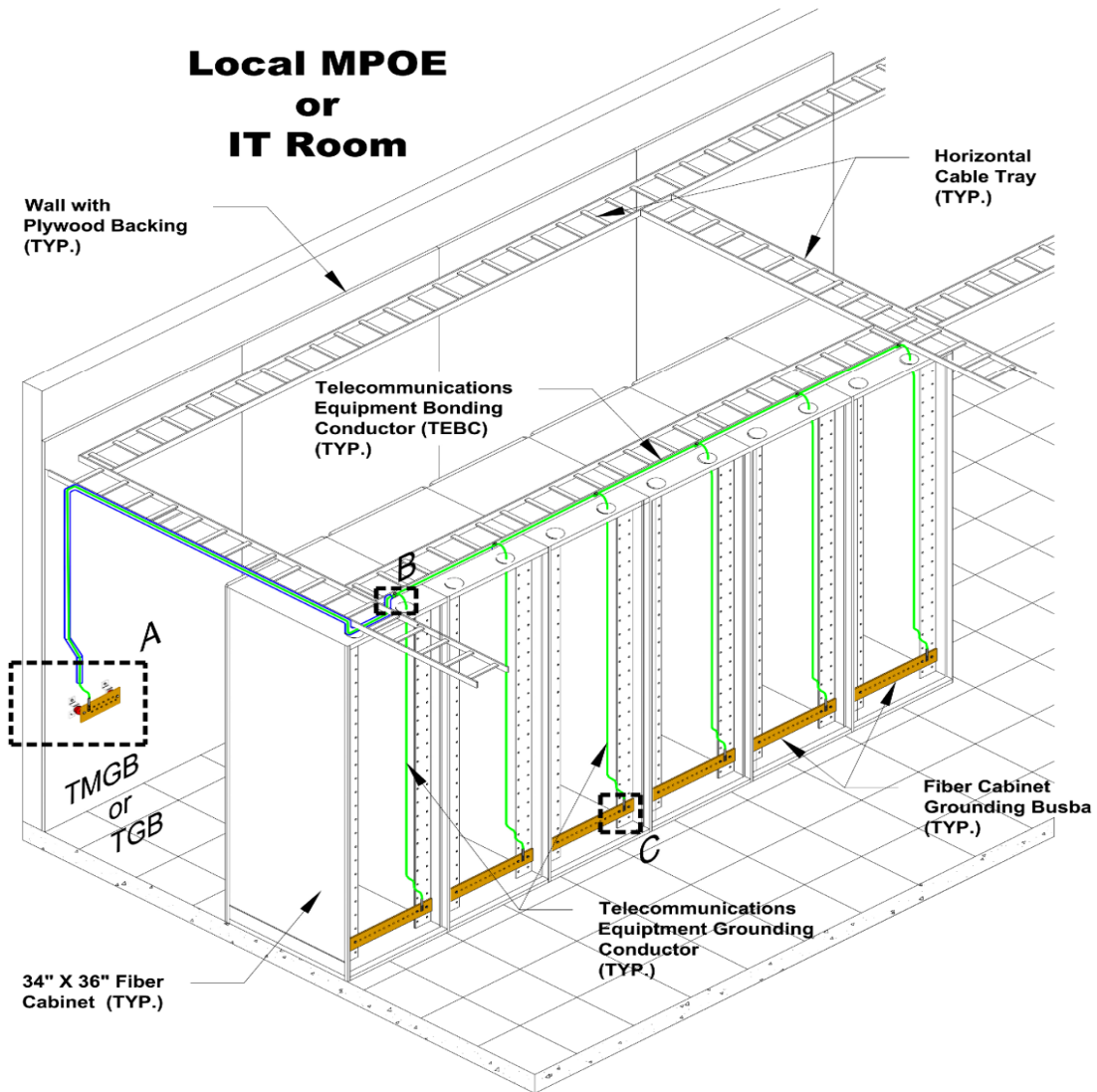
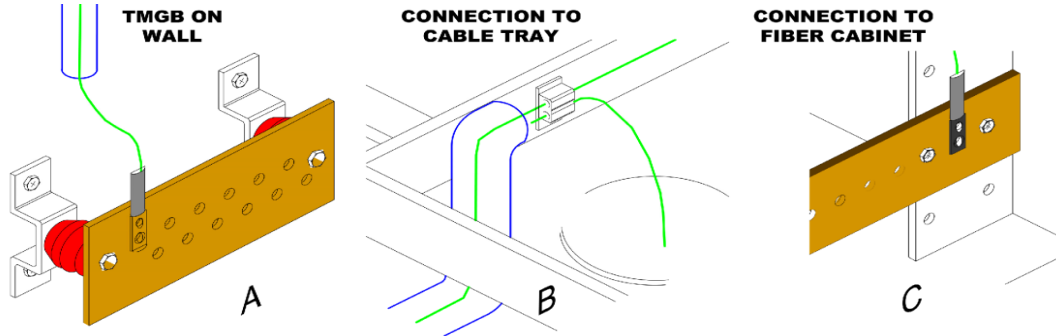

Equipment cabinet grounding busbars shall pigtail off the TEBC and not be daisy-chained.

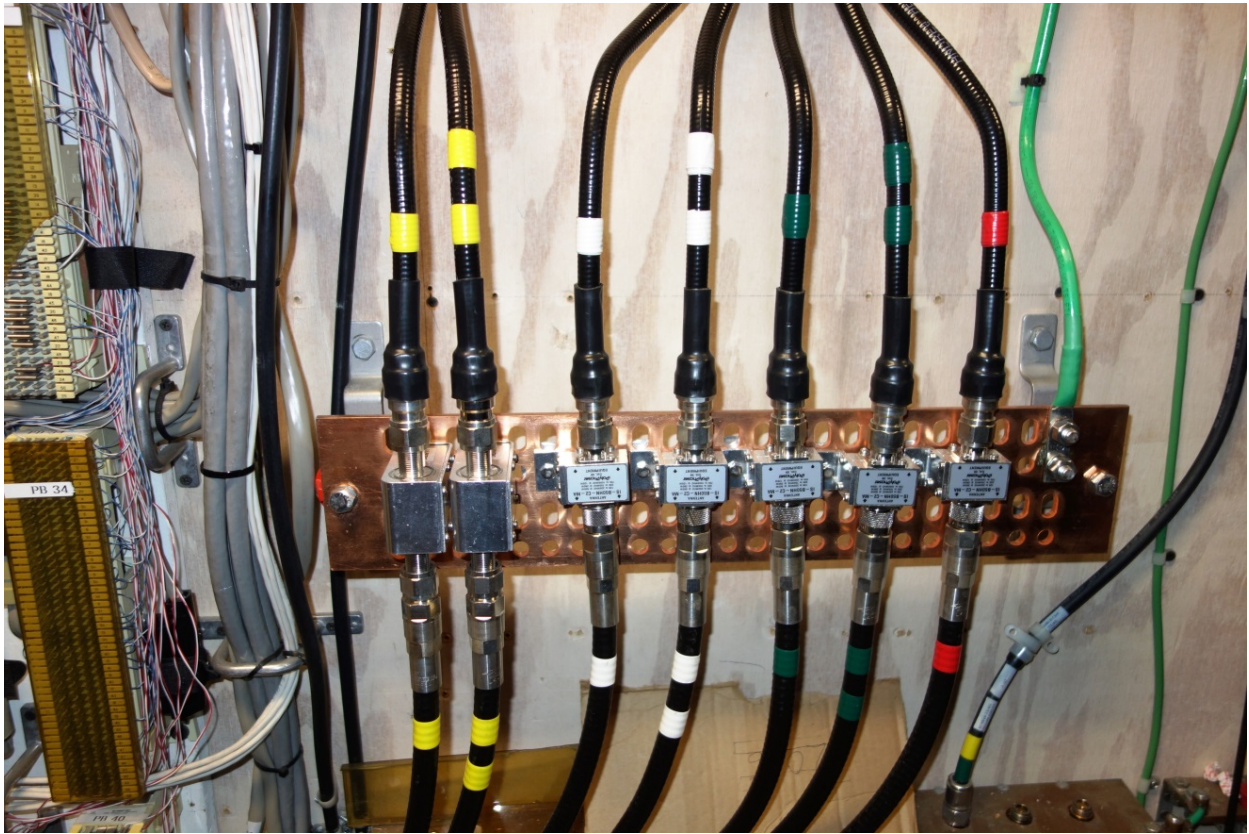

Antenna coax cable grounding bus bar shown.

2.56. L&S > COMMON ELEMENTS > HAZARDOUS MATERIALS

- 2.56.1. IT projects may be in or cross through areas that may contain lead based-paint, asbestos containing materials (ACM's) and/or other materials classified as toxic or hazardous by LAWA or Federal regulations.
- 2.56.2. The Contractor, and the Contractor's designer, shall take all necessary actions to mitigate any hazardous material.

Sample Area Map

Sample Type Asbestos

Lab Reference report no.:

Project Reference:

Note: ● = clean X = contaminated ; not drawn to scale

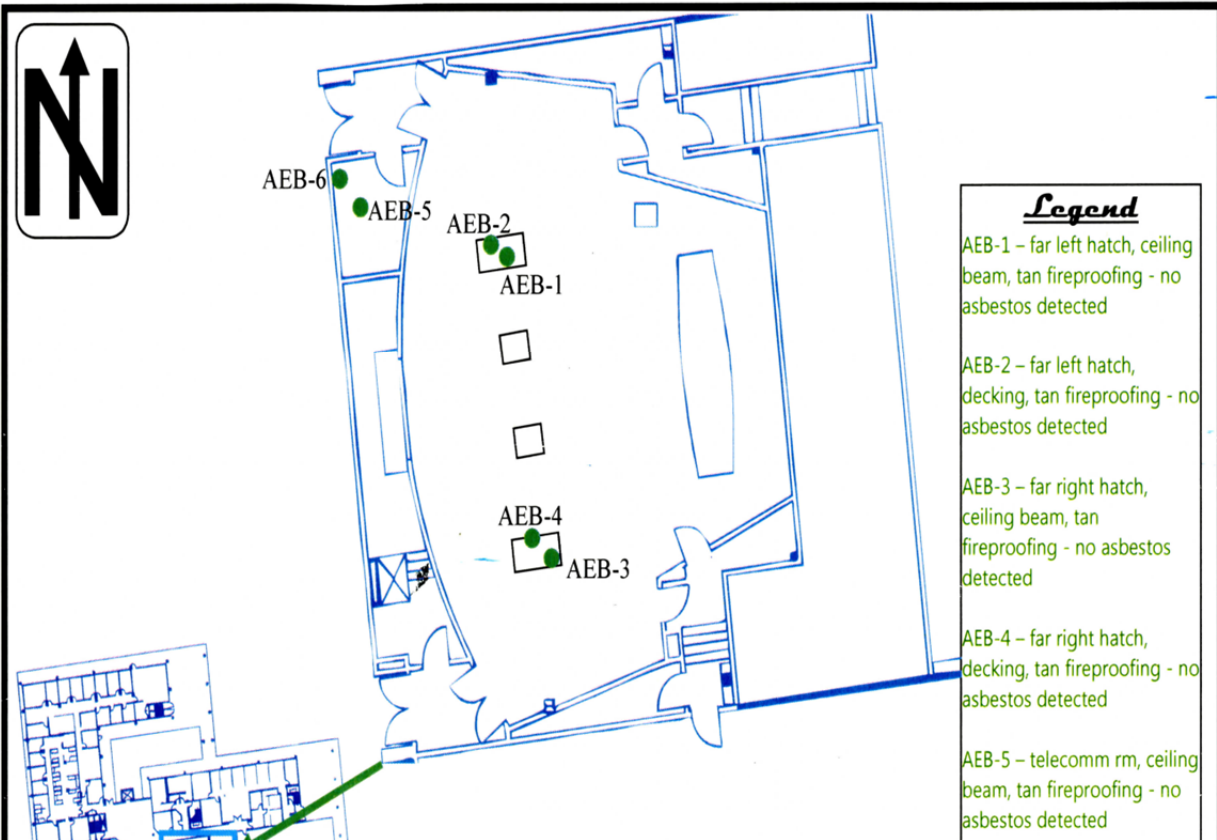

Testing required for areas suspected of having hazardous materials.

2.57. L&S > COMMON ELEMENTS > HVAC REMOTE MONITORING

- 2.57.1. All HVAC units shall have remote monitoring using a Liebert SSW-2E SiteLink interface allowing for communication with UPS and Mechanical systems. SiteLink shall include Liebert's leak detection system.



Liebert Site Scan electrical/mechanical monitoring units.



Remote monitor readout for the Liebert Site Scan unit.

2.58. L&S > COMMON ELEMENTS > LIGHTING

- 2.58.1. IT room lighting shall be installed in the aisle in front, behind, and between the cabinets at a level of 8-1/2 to 9 feet above finished floor.



2' x 2' LED light fixtures.



4-foot LED light fixtures.

- 2.58.2. Light fixtures shall be wired for both regular and emergency lighting.
- 2.58.3. Fifty percent (50%) of light fixtures shall be on stand-by power where available. Emergency lights shall also run during the day.
- 2.58.4. Lighting shall be bright enough to provide at least 538 lux or 50 foot-candles as measured at 18 inches off the finished floor.

2.59. L&S > COMMON ELEMENTS > LIQUIDS

- 2.59.1. IT Rooms and spaces shall be located away from sources of water and sewage (like rest rooms, restaurants, and concession spaces) – with the exception of existing legacy chilled water lines for Heating Ventilating and Air Conditioning (HVAC) units that are located within the IT rooms.
- 2.59.2. HVAC units shall be installed on concrete pads raised 4-inches above finished floor and extending out 6-inches from the equipment footprint in all directions.
- 2.59.3. Air Conditioning equipment shall have 2-inch drip pans placed underneath the entire perimeter of the HVAC unit.
- 2.59.4. HVAC units shall have condensate pipes that drain into the sewer or an evaporative unit.
- 2.59.5. Condensate drains shall be located as far as practical away from active IT equipment.



HVAC condensate containment pans prevent wet IT Room floors.



Enlargement of the condensate HVAC drip pan.



Ceiling-mount air conditioner with a fabricated drip pan and copper drain pipe.



Legacy HVAC condensate wall drain.

2.60. L&S > COMMON ELEMENTS > POSITIVE PRESSURE VENTILATION

2.60.1. All IT Rooms and MPOE's shall have positive pressure ventilation.



Legacy installation showing gap between doors allowing dirt inside.

2.61. L&S > COMMON ELEMENTS > SECURITY MONITORING

- 2.61.1. MPOE and IT Rooms shall have surveillance cameras within the room sufficient to cover all areas.
- 2.61.2. Camera model numbers shall be defined by the LAWA IT Security Systems Section.
- 2.61.3. All cameras shall be networked into the existing LAWA Video Management System as per LAWA's requirements for video storage.



Sample Legacy Netbotz surveillance camera - No longer used in IT rooms.



Sample Pan/Tilt/Zoom camera now used in IT rooms to replace Netbotz cameras.

2.62. L&S > COMMON ELEMENTS > SEISMIC ANCHORING

- 2.62.1. Back-to-back strut is permissible to use as a framework for pathway support and seismic anchoring if it is a minimum of 7' 6" above finished floor.



A strut framework for the seismic anchoring of cabinets ladder rack is shown.



Close-up of the seismic strut framework shown anchored to wall.

- 2.62.2. Strut is also permissible to create other support structures for junction boxes, etc.
- 2.62.3. All conduit, J-Hooks, cable tray, and equipment cabinets which exert force on the building structure shall be designed to meet seismic code.
- 2.62.4. All IT cabinet anchoring shall be designed to meet local seismic code based on a 2,000 pound fully populated cabinet weight.
- 2.62.5. All raceway support calculations shall meet all permit requirements.
- 2.62.6. Calculations shall be stamped by a California Professional Engineer and submitted for review by IMTG (Information Management and Technology Group).
- 2.62.7. Seismic detail drawings shall be provided as part of the as-builts.



Seismic supports shown connecting to strut that supports a cable tray.

1. Input data

Anchor type and diameter:	HIT-RE 500-SD + HAS, 3/4
Effective embedment depth:	$h_{\text{eff}} = 3.000 \text{ in.}$ ($h_{\text{st,inst}} = 3.000 \text{ in.}$)
Material:	ASTM F 568M Class 5.8
Evaluation Service Report:	ESR 2322
Issued Valid:	4/1/2010 -
Proof:	design method ACI 318 / AC308
Stand-off installation:	- (Recommended plate thickness: not calculated)
Profile	no profile
Base material:	cracked concrete, 2500, $f'_c = 2500 \text{ psi}$; $h = 4.750 \text{ in.}$, Temp. short/long: 32/32°F
Installation:	hammer drilled hole, installation condition: dry
Reinforcement:	tension: condition B, shear: condition B; no supplemental splitting reinforcement present
	edge reinforcement: none or < No. 4 bar
Seismic loads (cat. C, D, E, or F):	yes (D.3.3.5)



Geometry [in.] & Loading [lb, in.-lb]

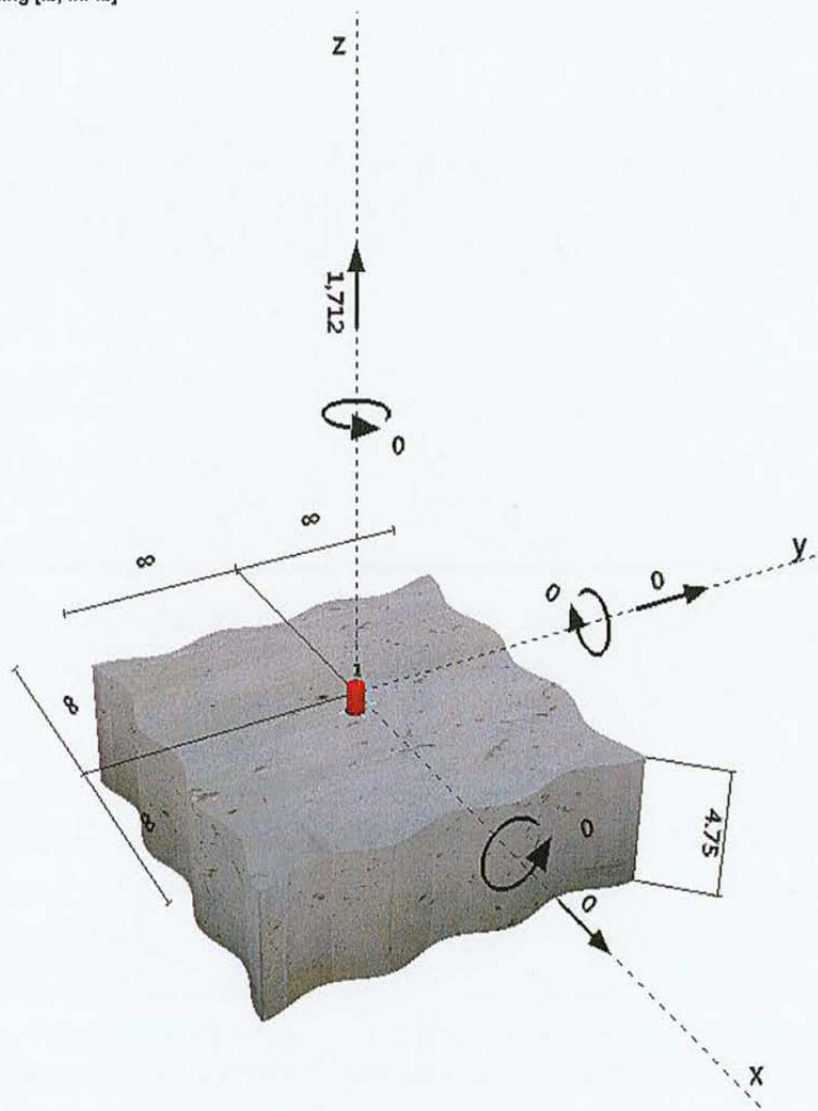

Sample partial input data sheet from a seismic structural calculation package.

2.63. L&S > COMMON ELEMENTS > TELEPHONES

- 2.63.1. Each MPOE and IT Room shall have one (1) wall-mount Cisco VoIP telephone installed near the center of the equipment cabinets.



Sample legacy IT room wall phones.

- 2.63.2. See LAWA IT for latest model number.
- 2.63.3. Wall phone shall be connected to the local network switch with CAT 6 cable.

2.64. L&S > COMMON ELEMENTS > UPS > SIZING

- 2.64.1. UPS's shall be sized according to the load served using the following chart as a guideline.

<u>Room Size</u>	<u>UPS Size</u>	<u>UPS Mounting</u>	<u>Manufacturer</u>
2 cabinets or less	5,000 VA	Rack-mount	APC
Between 3 and 5 cabinets	10 kVA	Floor-mount	Liebert
6 cabinets	20 kVA or greater	Floor-mount	Liebert
8 cabinets	30 kVA or greater	Floor-mount	Liebert

2.65. L&S > COMMON ELEMENTS > UPS > GENERAL

- 2.65.1. IT Room and MPOE UPS's (designed to service the entire IT Room) shall be installed in the electrical room or a room separate from, but adjacent to the IT Room.
- 2.65.2. IT Room and MPOE UPS's shall be backed up by the facility generator through an external Automatic Transfer Switch (ATS) that is installed in a room separate from the IT Room.
- 2.65.3. IT Room and MPOE UPS's shall be provided with a Liebert SiteLink system connected to LAWA's network for remote monitoring.

2.66. L&S > COMMON ELEMENTS > WALLS

- 2.66.1. Sanded 3/4" x 4' x 8' fire-rated plywood shall be installed on all walls of the IT Room, MPOE, and Service Provider entrance Facility.

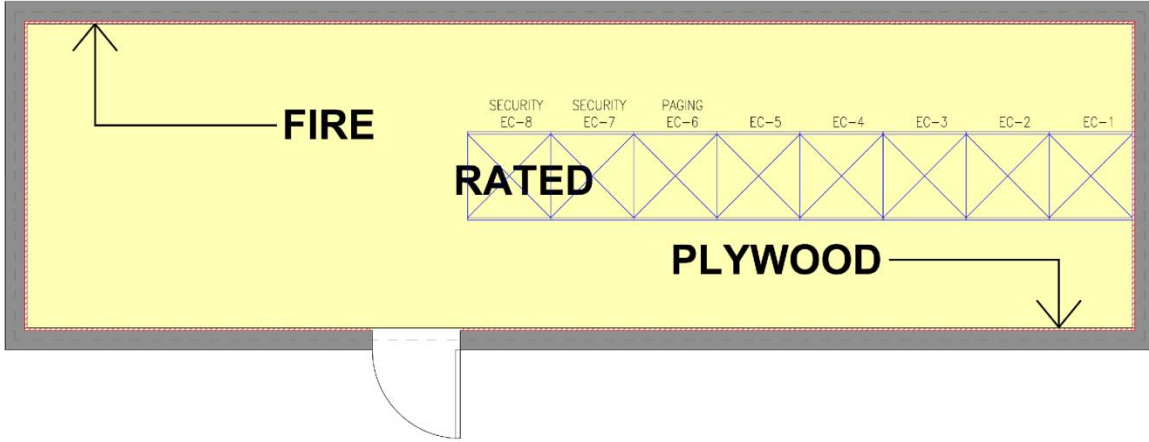

Plywood installed on walls opposite where cabinets are installed.

- 2.66.2. Plywood shall be painted offsite with two coats of white semi-gloss water-based paint. Plywood shall not be painted in the IT room.
- 2.66.3. In metal studs, plywood shall be fastened with #12 x 2" zinc-plated, pan or truss-head or k-lath self-drilling sheet metal screws or toggle bolts or equivalent.
- 2.66.4. In concrete walls, plywood shall be fastened with 5/16" or 1/4" toggle bolts or drop-in anchors or equivalent.
- 2.66.5. Plywood shall not be fastened with powder-actuated systems.
- 2.66.6. Fire-rated stamps shall not be painted over.



Unpainted stamps for local AHJ inspection.

- 2.66.7. Plywood shall be installed level just above the cove molding or if cove molding not installed, then plywood may be installed at floor level, and then cove molding shall be applied to the wall.
- 2.66.8. Plywood cutouts shall be made for all electrical and communications outlets allowing $\frac{1}{4}$ " overall clearance so that the face plate can be removed and the outlets accessed.
- 2.66.9. Plywood installed in existing legacy IT Rooms shall be installed in multiples of whole $\frac{3}{4}$ " x 4' x 8' sheets. Partial pieces of plywood shall not be allowed.
- 2.66.10. For renovations, plywood shall be installed in multiples of $\frac{3}{4}$ " x 4' x 8' sheets. Plywood shall be installed as indicated above.



Fire-rated plywood stamps shown unpainted on painted plywood backboard.

2.67. L&S > COMMON ELEMENTS > WINDOWS

2.67.1. Windows are not permitted without IMTG's approval.



Legacy IT room showing windows.