



1.1 STRUCTURAL

- A. To the extent possible, metal stud partitions will be constructed on a 6" high concrete curb.
- B. Plumbing chase and Custodial Rooms will have 6" high concrete curb at all perimeter walls.

1.2 MECHANICAL

- A. Restrooms will have a minimum of 15 air changes per hour.

1.3 PLUMBING

- A. To the extent possible, water shut-off valves, temperature control valves, electrical transformers, etc. will be located within 30 horizontal inches of a ceiling access panel.
- B. Alternative location of access panel will be located under the lavatory countertop concealed behind the stainless steel skirt.
- C. Plumbing service chase access will be through a door no less than 30" wide. Access to plumbing chase from inside restrooms rooms will be avoided. Access to plumbing chase from inside the Custodial Room will be avoided.
- D. Restroom Layouts in new construction and restroom renovations where space permits will incorporate a plumbing service chase with a minimum clearance of 18" from point of access to and behind all plumbing fixtures. Where plumbing fixtures require cleanouts, a 30" free and clear path will be provided for service equipment and personnel.
- E. If a plumbing service chase with the above mentioned clearances cannot be met, cleanouts shall be turned into the public space.
- F. Plumbing service chase will have a minimum of one (1) drain, centrally located, free and clear of any obstruction and in close proximity to back of fixtures.

1.4 ELECTRICAL

- A. At least one (1) convenience GFCI electrical outlet will be provided in at least one (1) ADA stall and one (1) above each diaper changing station.
- B. Provide one (1) convenience GFCI electrical outlet in plumbing service chase at each end of fixture banks to power maintenance equipment.
- C. One (1) distress button with data connection to the LAX Airport Response Coordination Center (ARCC) will be provided in each single use All Gender/Family Restroom, Nursing Room, and Pet Relief Room where isolated passengers can call for help in the event of an emergency. Distress button device faceplate shall be waterproof and have continuous caulking. Mounting height will be 15" from finished floor to center of distress call button. It shall be located adjacent to a water closet for fallen passengers to call for help.
- D. Electrical equipment will not be located in any Custodial Room, Restroom, or any other wet room.
- E. Provide one (1) GFCI electrical 120v outlet for each electrical adult changing table.

1.5 LIGHTING

- A. Continuous, wall to wall, indirect linear lighting will be installed above all lavatories, water closets, urinals and feature walls as the primary means of illuminating these areas.
- B. All other required lighting will be fully recessed in the ceiling.



PUBLIC RESTROOMS, DESIGN INTENT

Los Angeles World Airports

- C. Self-illuminating mirrors, mirror edge lighting, wall sconces, or candelabra fixtures will not be used.

1.6 DOORS

- A. Unless otherwise required by Building Code or if unique space constraints exist, doors will not be used to enter restrooms.
- B. Restroom entry vestibules will have 48" wide minimum clear openings that are arranged to allow free-flow traffic without sightlines into the restrooms.
- C. Where doors are required, doors, frames and hardware will be in compliance with the door and lock specifications provided in Section 08 00 00 of the Guide Specifications (Design & Construction Handbook).

1.7 CEILINGS

- A. Ceiling heights will be 9'-0" minimum above finished floor.
- B. Porous ceiling materials are not acceptable.
- C. Ceiling will be cement plaster or water resistant gypsum board.
- D. All ceilings will be painted.
- E. All access panels, registers and grills will be painted to match ceiling.

1.8 TOILET PARTITIONS

- A. Toilet partitions will be stainless steel as per specifications provided in section 10 21 13 of the Guide Specifications (Design & Construction Handbook).
- B. Typical toilet stalls in new construction and in new restroom layouts in existing structures where space permits will be 3'-6" x 6'-6" as shown in *Figure 1.8B*.
- C. Ambulatory and accessible stall widths will be sized to meet the applicable code requirements. In existing structures where spatial constraints do not permit the above, code requirements will govern.

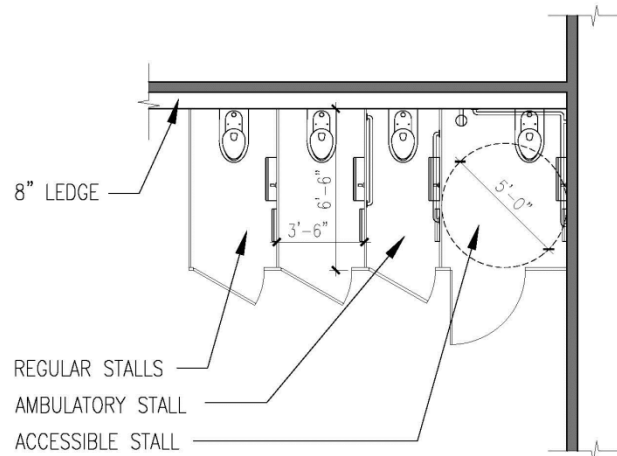

Figure 1.8B
PREFERRED TOILET STALL SIZES



PUBLIC RESTROOMS, DESIGN INTENT
Los Angeles World Airports

- D. Toilet partitions will be ceiling hung and rigidly fastened to structural steel supports concealed in ceiling plenum.
- E. To limit partition racking, additional floor pedestal supports will be provided every 2-3 stalls.

1.9 FINISHES

A. Design Color Palette

- 1. Restrooms colors will be limited to three (3) distinguishable values of white to grey color scale (preferably warm grey), a single accent color in specific locations and natural finished stainless steel.
- 2. Restroom Vestibule/entry walls will be the darkest and richest value (i.e. Dark Grey). Floors and bases are to be the middle value (i.e. Medium Grey). Ceilings, wall field tile and lavatory/counters will be the lightest value (i.e. White).
- 3. Accent colors are to be a single hue or color of glass tile and are limited to above the water closets and on feature walls defined as single plane walls without openings, fixtures or accessories.
- 4. Each restroom is limited to (1) one color.

B. Walls

- 1. Wall tile finish assembly will be per the specifications provided in Section 09 30 00 of the Guide Specifications (Design & Construction Handbook).
- 2. Wall field tile will be ceramic tile laid up in a horizontally balanced and consistent pattern from corner to corner and bottom to top. Rectangular tiles will be laid horizontally. Horizontal stack bond pattern is preferred. Wall field tile will start with a full tile above the wall base tile. See *Figure 1.9B3*.
- 3. Wall field tile will be square or rectangular with no dimension less than 4".
- 4. Behind water closets, the wall field tile will be from top of wall base tile to approximately 60" above finish floor (AFF) and end with a full tile.
- 5. Behind water closets where wall field tile ends (approx. 60" AFF) glass color accent tile, starting with a full height tile, will run to the ceiling as shown in *Figure 1.9B5*.
- 6. Glass Tile will be square or rectangular and with no dimension less than 4". Size and bond pattern of glass tile will match the field tile pattern where possible and course out with field tile in all cases.
- 7. If accent tile is used, it will be above 60" and run to the ceiling. If accent tile is not used, wall field tile will run to ceiling. No exposed wall finishes will be painted gypsum board.
- 8. Tile grout will be epoxy and white for all wall tile applications.
- 9. Colored accent tile will only be used above urinals where urinals and water closets are on a common wall. In such cases, the ledges and accent color tile will be consistent from inside corner to inside corner.



PUBLIC RESTROOMS, DESIGN INTENT

Los Angeles World Airports

10. Restroom layouts in new construction will have a solid surface ledge at approximately 60" AFF behind water closets and urinals and in existing structures where space permits. Ledge solid surface material will match the lavatory countertops.
11. Transitions from one material to another or one color to another, will only occur at inside corners and at stainless steel cased openings between two adjacent spaces. The use of two colors or dissimilar materials is not permitted on walls in the same plane regardless of whether they are separated by a floor to ceiling stainless steel cased opening
12. Stainless Steel (306, No 6 Finish) flush corner guards will be used at all outside corner of all tile walls from top of wall base to ceiling. At the end of tiled partitions, single stainless steel end cap installed flush to the surface of the tile can be used in lieu of two flush corner guards.
13. Custodial Room wall finish will have tile installed above the mop sink to a height of 36 inches. The remainder of the wall finish will be painted impact resistant, water resistant gypsum board.

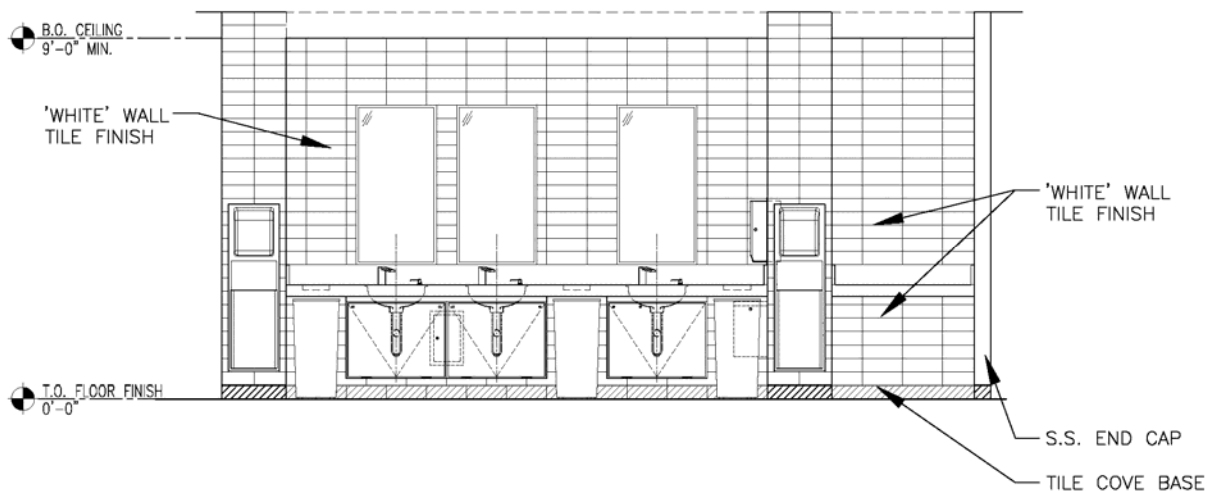

Figure 1.9B3
WALL FINISH AT LAVATORIES



PUBLIC RESTROOMS, DESIGN INTENT
Los Angeles World Airports

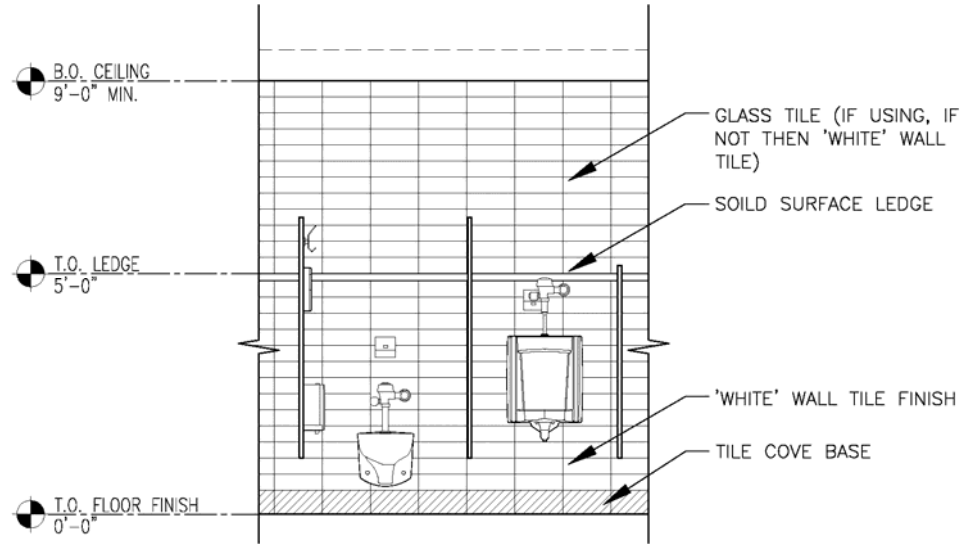

Figure 1.9B5
WALL FINISH AT URINALS AND WATER CLOSETS

C. Floors

1. Restroom floor tile finish assembly will be per the specifications provided in Section 09 30 00 of the Guide Specifications (Design & Construction Handbook).
2. Floor finish will have positive slope to floor drain(s).
3. All exposed concrete floors will be smooth and have a high performance, waterproof polyurethane sealant that is chemical resistant, and abrasion resistant.
4. Waterproof membrane at finished floors shall extend up the wall structure for at least 3 feet high behind all wall hung plumbing fixtures and 12 inches high for walls without plumbing fixtures.
5. Restroom floor tile finish color will be **'Medium Grey'**.
6. Tile grout will be epoxy and **'Medium Grey'** for all floor tile applications.
7. Restroom tile cove base will be provided and match floor tile and extend up the wall as shown in *Figure 1.9C7*. Non-tile cove bases and cove strips are not acceptable.

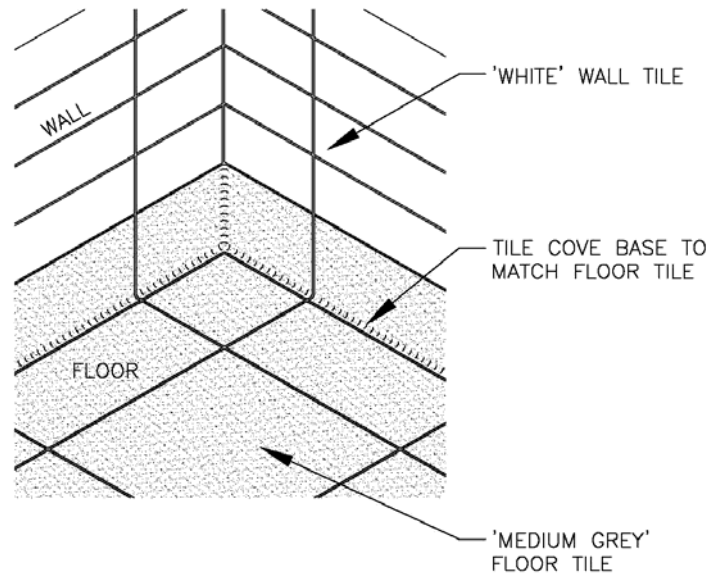

Figure 1.9C7
TILE COVE BASE

1.10 UNDER COUNTERTOP LAVATORIES/TRASH DROP LAYOUTS

- A. Restroom countertops will be per specifications provided in section 06 61 16 of the Guide Specifications (Design & Construction Handbook).
- B. Restroom countertops will be solid surface acrylic polymer product.
- C. Engineered stone is not acceptable.
- D. Countertops will all have positive slope to lavatories.
- E. A continuous integral splash will be provided at all walls adjacent to lavatories and trash drops.
- F. Integrally mixed automatic faucet and soap dispenser will be installed at 45 degree angle from centerline of lavatory.
- G. A circular stainless steel finished thru counter trash drops will be provided at the end of each pair of lavatory /wash stations.
- H. A standard removable stainless steel trash receptacle will be provided under each trash drop.
- I. Stainless steel trash receptacles shall be at least 29 inches tall, no more than 15 inches deep and no more than 14 inches wide.
- J. No enclosure will be provided in front of trash receptacles.
- K. One (1) bulk soap dispensing reservoir accessible with removal of the trash receptacle will be provided at each restroom. The entire restroom layout needs to begin with the soap reservoir cabinet.
- L. A removable stainless steel skirting (matching the S.S. toilet partition pattern and finish) will meet ADA code requirements and will be provided under each lavatory to allow access to plumbing for maintenance purposes.
- M. Clear dimension of 30-1/2" will be maintained from finish floor to bottom of counter for the full length of counter.



PUBLIC RESTROOMS, DESIGN INTENT
Los Angeles World Airports

- N. Floor finish will be sloped to and from this line of demarcation to achieve positive slope to floor drain(s).

1.11 ACCESSORIES

- A. All Public Restrooms will be equipped with a diaper changing station. Location of diaper changing station preferential order:
1. Along main circulation path: solid surface fixed-type ledge/countertop with no depressions, or stainless steel with a front lip.
 2. Along main circulation path: Recessed, stainless steel, “flip down” model.
 3. In ADA stall: Recessed, stainless steel, “flip down” model.
- B. Coat hooks will bear 150# weight, installed on latch side of the toilet stall where partition door opens out. If partition door opens in, coat hook will be installed on the hinge side in the door shadow free and clear of partition door impact as shown in *Figure 1.11B*. At end conditions where adjacent wall is demising, coat hook to be on adjacent demising wall and clear of partition door impact. Coat hooks will be anchored to integral structural members inside the toilet partitions sized to carry the load. Coat hooks installed on toilet partitions doors are not acceptable.
- C. Paper Towel Dispensers will be located adjacent to lavatory stations on the side wall to minimize hand water drip accumulation along the passenger circulation paths. Provide a Paper Towel Dispenser in compliance with ADA requirements.
- D. Paper Towel Dispensers are the primary drying source. A Warm Air Dryer is a secondary drying source and will be per specifications provided in section 10 28 00 of the Guide Specifications (Design & Construction Handbook).
- E. Wall mounted foam/liquid soap dispensers are not allowed.
- F. Restroom Layouts in new construction and restroom renovations where space permits will have through counter trash drops located at both ends of lavatory/counters and typically at every two lavatory stations.
- G. In restroom renovations where spatial limitations prohibit *item 1.11.F* above, a minimum two (2) trash drops for every three (3) wash stations will be provided.
- H. Under exceptional circumstances and only when approved by LAWA, one (1) trash drop will be provided for every three (3) wash stations. Individual stainless steel framed mirrors (24”x48”) will be provided as shown in *Figure 1.9B3* in new construction or sized and mounted from top of splash in restroom renovations.
- I. One (1) Emergency call button speaker phone will be installed in each individual isolated Public Restrooms, Nursing Room, Pet Relief Room, Family Restrooms and All Gender Restrooms as per section 27 21 00 of the Guide Specifications (Design & Construction Handbook). Mounting height shall be 15” above finished floor.



PUBLIC RESTROOMS, DESIGN INTENT

Los Angeles World Airports

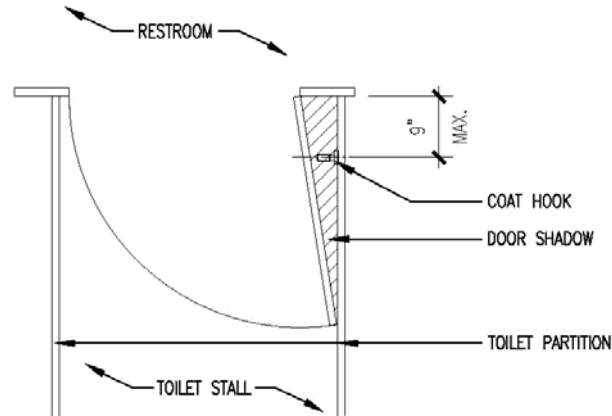

NOTE: PREFERRED TOILET PARTITION DOOR WILL SWING OUT. IN THE EVENT THAT SPACE DOES NOT PERMIT THIS AND A PARTITION DOOR MUST SWING IN, THIS DIAGRAM ILLUSTRATES THE COAT HOOK PLACEMENT IN THE DOOR SHADOW PREVENTING DOOR AND COAT HOOK IMPACT.

Figure 1.11B
SWING-IN PARTITION DOOR COAT HOOK

1.12 CIRCULATION SPACE

- A. Circulation space between lavatory counter and toilet compartments will be 7'-0" minimum as shown in *Figure 1.12D*.

1.13 NURSING ROOM

- A. Required in commercial airports with more than 1,000,000 enplanements per year at each terminal post security as described in the State of California Assembly Bill 1787.
- B. Floor tile finish per section 1.9 of this document.
- C. Wall tile finish per section 1.9 of this document.
- D. Ceiling finish per section 1.7 of this document.
- E. Restroom layouts in new construction and renovation projects will provide one (1) private Nursing Room for passengers post security in each Terminal.
- F. The Nursing Room will not be accessible from inside the Restrooms. It will be accessible from the main public circulation path or directly from the entry vestibule to the Women's Restroom as shown in *Figure 1.12D*.
- G. The Nursing Room door will not open directly onto the main public circulation path as shown in *Figure 1.12D*.
- H. A water closet or urinal is not allowed in the Nursing Room.
- I. A diaper changing surface is not allowed in the Nursing Room.
- J. The Nursing Room will have a thumb-turn locking mechanism with indicator display per section 08 71 00 of the Guide Specifications (Design & Construction Handbook).
- K. The Nursing Room will have the following minimum amenities per Guide Specifications of the LAWA Design and Construction Handbook (in compliance with ADA requirements):
 - 1. Lavatory with faucet and soap dispenser as described in section 1.10 of this document.



PUBLIC RESTROOMS, DESIGN INTENT

Los Angeles World Airports

2. 30" minimum wide countertop adjacent to lavatory where space is available.
3. Paper Towel dispenser.
4. Trash container.
5. Convenience GFCI electrical duplex outlet located above the countertop, opposite the lavatory.
6. One (1) single, padded bench or chair for nursing passengers to sit.

1.14 SINGLE USE FACILITY / ALL GENDER / FAMILY RESTROOMS

- A. Required in any business establishment, place of public accommodation, or state or local government agency and shall be identified as all-gender toilet facilities by signage that is designated for use by no more than one occupant at a time or for family or assisted use as described in the State of California Assembly Bill 1732.
- B. This room shall serve and accommodate passengers traveling with companions, passengers traveling with the opposite sex and passengers traveling with children.
- C. Signage for this room shall be identified as All Gender Restroom per the signage standards in the LAX Terminal and Wayfinding Standards (Design & Construction Handbook).
- D. Floor tile finish per section 1.9 of this document and match the Public Restrooms.
- E. Wall tile finish per section 1.9 of this document and match the Public Restrooms.
- F. Ceiling finish per section 1.7 of this document and match the Public Restrooms.
- G. One (1) separate single use All Gender Restroom will be provided in new construction and restroom renovations.
- H. All Gender Restroom doors will not open directly onto the main public circulation path as shown in *Figure 1.12D and 1.14*
- I. A diaper changing station will be provided per section 1.11 of this document.
- J. One (1) GFCI duplex outlet will be provided above the countertop, opposite the lavatory.
- K. One (1) ADA compliant adult size water closet will be provided.
- L. One (1) Adult Changing Station will be provided. It will be a powered height adjustable model, flip down, with wired hand control, and holder. Unit will plug into 120v outlet located within 3 feet of model. Table surface will be solid, durable and easily cleanable. Table dimensions will be a minimum of 30"x70" and include a safety rail. Model will not have a curtain attachment, or a water collection tray.
- M. One (1) ADA compliant urinal is allowed where space is available.
- N. If space allows, provide one (1) single padded bench or chair to accommodate companion seating or other family members.



PUBLIC RESTROOMS, DESIGN INTENT
Los Angeles World Airports

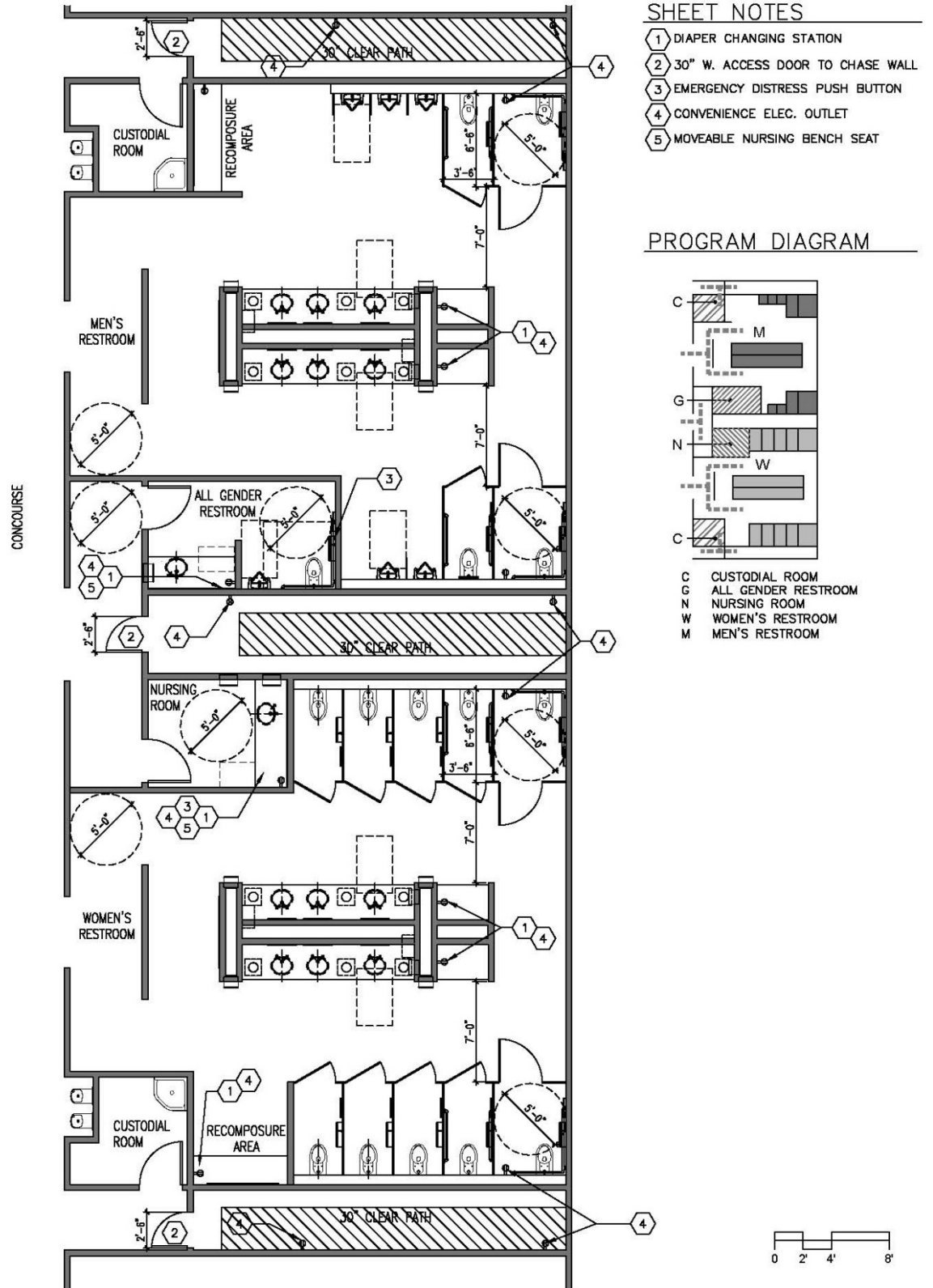



PUBLIC RESTROOMS, DESIGN INTENT
Los Angeles World Airports

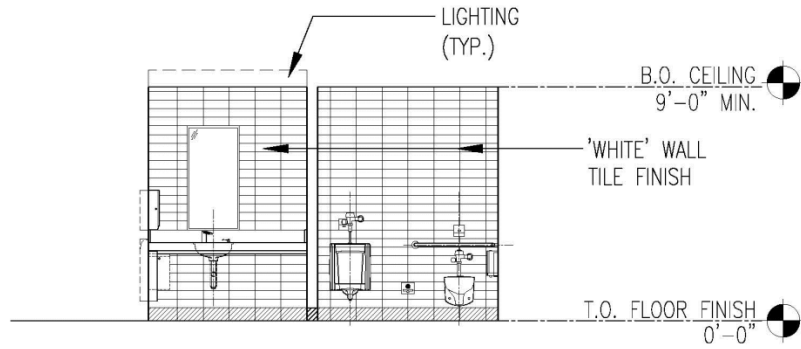

INTERIOR ELEVATION – ALL GENDER RESTROOM

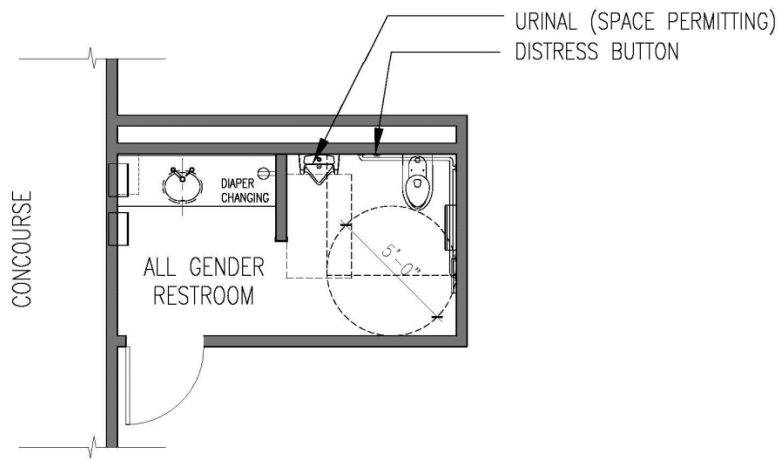

FLOOR PLAN – ALL GENDER RESTROOM

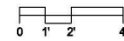

Figure 1.14
FAMILY RESTROOM PLAN AND ELEVATION

END OF SECTION