

LAX Tenant Signage Standards



*Los Angeles
World Airports*

Los Angeles International Airport

Prepared by
Planning and Development Group
September 2018

General Information

Introduction 1.1
 Purpose & Intent 1.2
 Intent of Tenant Signage at LAX 1.2
 Purpose of Tenant Signage Standards 1.2
 Procedures 1.3
 Sign Submittal & LAWA Approval 1.3
 Review & Compliance 1.3

Standards & Regulations

Sign Regulations 2.1
 Responsibility & Intent 2.1
 Sign Placement 2.1
 Illumination 2.1
 Assemblage 2.2
 Materials 2.2
 Fabrication & Installation 2.3
 Maintenance 2.3
 LAWA Standard Font 2.3
 Applicable Code Requirements 2.4
 ADA Code Requirements 2.5
 Regulation Enforcement 2.6
 Alliances, Partnerships & Code Share 2.7
 LAWA Wayfinding Signs 2.8
 U.S. Customs Signage 2.9
 Informational Signs Not Related to
 Construction 2.10
 Temporary Sign Requirements
 During Construction 2.11
 Ordering Signs 2.11
 Installing Signs 2.11
 Sign Holders 2.11

Maintenance of Signs and

 Sign Holders 2.12
 Project Identification Sign 2.12
 Promotional Signs 2.13
 Coming Soon Graphics 2.13
 Prohibited Signs 2.13
 Acceptable Caution and
 Warning Signs 2.13
 Signs not produced or installed by
 the PDG Sign Shop 2.13

Terminal Signs

Exterior

 Jetway 3.1
 Curbside Check-in 3.2
 Curbside Check-in - Alliance 3.3

Interior

 Ticketing Backwall 3.4
 Ticketing Backwall - Alliance 3.5
 Ticket Kiosk 3.6
 Queue 3.7
 Countertop 3.8
 Luggage Size Check 3.9
 Boarding Wall 3.10
 Baggage Claim 3.12
 Baggage Service Office 3.14
 Baggage Service Office - Alliance 3.15
 Information Display System 3.16
 Passenger Lounge Directional 3.17
 Passenger Lounge Identification 3.18
 Office Identification 3.19

Office & Warehouse Signs

Exterior

Restrictions 4.1
Tenant Sign Types 4.2
Master Tenant Standards 4.3
Master Tenant Signature Sign Sizes 4.4
Sub-Tenant Standards 4.5
Sub-Tenant Signature Sign Sizes 4.6
Signature Sign Sizes 4.7

Hangar & Service Building Signs

Exterior

Restrictions 5.1
Master Tenant 5.2
Master Tenant Sign Types 5.3
Sub-Tenant 5.6
Sub-Tenant Sign Types 5.7
Signature Sign Sizes 5.10

Facilities Signs

Exterior

Street Address. 6.1
Monument 6.2
Fence 6.3
Directional 6.4

Terminal and Door Numbering

Overview & Rules. 7.1
Exceptions 7.2
Door Tag Numbering Procedure 7.3
Example of MAXIMO designations . . . 7.5
Door Tag Numbering Components 7.6
Door Numbering Process 7.7
Rooms with Multiple Entrances. 7.9
Front Door Numbering System and
Terminal Address 7.10

Terminal Stair Numbering

Overview, Guidelines, and Approval. . . . 8.1
Clockwise Numbering 8.2

Design Review Process

Step 1 - Conceptual Design Submittal . . . 9.1
Conceptual Design Submittal Checklist . 9.1
Step 2 - Design Development &
Construction Documents 9.2
Tenant Construction 9.2

Glossary 10.1

General Information



*Los Angeles
World Airports*

Los Angeles International Airport



People looking for destinations and information require signs—text and graphic elements to guide them. In a civic environment such as Los Angeles International Airport (LAX), signs identify traffic routes, buildings, facilities and activities. These are all elements which communicate information.

Graphic elements are an integral part of the visual landscape at LAX—the image over-lap of two and three dimensional forms together make up our civic architecture. It is important that these elements, which identify and inform, be visually integrated to their site and structure.

The LAX Tenant Signage Standards are designed to promote a well-integrated, complete signage program that will help the public use the airport efficiently and with a minimum of confusion. These standards cover both exterior as well as interior signage for all of the property under the jurisdiction of Los Angeles World Airports (LAWA).

These Standards will function as an efficient reference source, while at the same time promote tenant signage that is attractive and utilizes colors and materials that are compatible with its surroundings.

Please note that these Tenant Signage Standards are not applicable to concession signage. For that information refer to LAWA's Concession Design Guidelines document dated August 2006.

Intent of Tenant Signage at LAX

Tenants are encouraged to be expressive and imaginative when designing signs to aid the public in using airport facilities efficiently and with a minimum of confusion. In short, the acceptable criteria for each sign is that it address the immediate needs of airport users.

The intent of signage is to provide adequate direction so that the sign systems will:

1. Provide an effective source of needed information.
2. Maintain quality of design that is compatible with the aesthetics of LAX. Great importance is placed on good taste, originality and fine materials.
3. Be attractive and use colors and materials that are compatible with the design of individual terminals.

Advertising is allowed on an annual exclusive contractual basis. Inquiries are to be directed to:

Commercial Development Group
Los Angeles World Airports
6053 W. Century Boulevard, Suite 400
Los Angeles, CA 90045
Tel: (424) 646-7200
Fax: (424) 646-9256

Purpose of the Tenant Signage Standards

The Tenant Signage Standards establish conformance criteria for all tenant signage proposed for existing, new and remodeled facilities under LAWA jurisdiction at the airport and its environs. These Standards replace the LAX Sign Code dated April 16, 1975. They are meant to provide the maximum limitations for tenant signing of any kind allowed in these areas.

The Standards will be periodically reviewed by LAWA and are subject to revision at its discretion. Tenants will be notified of revisions to the Standards. All tenants are encouraged to submit suggestions for improvements to:

Signage and Graphics Manager
Los Angeles World Airports
Planning and Development Group
6053 W. Century Blvd., Suite 603
Los Angeles, CA 90045

Sign Submittal & LAWA Approval

Tenants are required to follow the submittal process for all proposed signs as detailed in the Design Review Process section of these Standards. All tenant signs must have the written approval of the Signage and Graphics Manager, or his/her designee prior to installation. New, changed or renovated signs will conform to these guidelines.

It is understood that any signs not having the express written approval of the Deputy Executive Director, Commercial Development Group will not be installed. Any existing installed sign not having the approval of LAWA will be removed.

If any existing sign exceeds the limitation stated in the Standards, but has been previously approved by LAWA, that sign will be allowed to remain installed. However, if there is to be a change, modification, renovation or relocation in any way involving previously approved and installed signage, LAWA will require that this signage be upgraded to conform to the current Standards.

Temporary signs must be submitted for review to the Planning and Development Group prior to installation. Refer to the “Temporary Signs” information in the Standards & Regulations section for details.

Review & Compliance

All signs are subject to periodic reviews by LAWA to insure compliance to these Standards. Signs will be inspected for content compliance and to insure that the minimum sign fabrication quality is maintained. This will include sign structure, paint or finish, and applied materials, i.e., plastics, vinyl lettering, fasteners, etc. Internally illuminated signs will be checked for proper working order before final acceptance.

In the event that an existing sign is found to be out of compliance with these Standards, LAWA will notify the tenant with a written notice. The tenant is required to remove and refurbish the sign up to or exceeding the quality of the original permitted condition according to the guidelines described in the Regulation Enforcement section of these Standards. If the tenant’s sign does not satisfy permitted condition standards at the end of the prescribed adjustment period, LAWA reserves the right to directly resolve the matter by removing it and billing all costs to the tenant.

Standards & Regulations



*Los Angeles
World Airports*

Los Angeles International Airport



Responsibility & Intent

1. Signage in public areas is the responsibility of LAWA. Signage within leased areas is the responsibility of the tenant.
2. All signs will be of an informative nature designed to meet the immediate needs of the public. Signs of an advertising or promotional nature, including contact information, are not permitted.
3. Freestanding or pole-mounted signs are used for information and directional information only.
4. All signs will meet all federal and local safety standards and code requirements, including all ADA Guidelines.
5. Signs not covered in these standards are to be considered prohibited. Exceptions may be granted if such additional signage serves the public.
6. All verbiage on signs must be displayed in English only. No foreign languages are allowed.

Sign Placement

1. No signs will be permitted on doors or windows except those required to meet safety standards. Some exceptions are noted in these Standards.
2. No signs will be permitted on the roof of any building. This regulation also applies to any structure atop a building, such as ticketing building pylons.

3. All signs are to be surfaced-mounted within the architectural elevation of the demised premises unless otherwise approved by LAWA.
4. No signage will be permitted on semicircular, center metal walls in the remote bus holding areas or semicircular center core walls in the satellite buildings unless otherwise approved by LAWA.

Illumination

1. Only one sign per business establishment may be illuminated between the hours of sunset and 10:30 p.m., according to the City of Los Angeles energy conservation ordinance.
2. Only individually mounted, internally illuminated letters, pin mounted and back washed letters are acceptable. No cabinet signs are permitted.
3. No exposed neon, animated, or flashing signs are permitted. Internally illuminated signs will be kept to a minimum using translucent acrylic diffusion to control the brightness. Illuminated signs will be allowed only in specific circumstances mentioned in the text of these standards. All illuminated signs will meet all code requirements and bear the label of the Underwriters Laboratories, Inc.

Assemblage

1. No exposed can, raceways, or crossovers will be permitted.
2. Capital Height (Cap. Ht.) is defined as the distance from the top of a capital letter form to the bottom of the same letter form. Capital Height when applied to number forms is measured as the distance from the top to the bottom at the tallest numeral.
3. Letter area height is defined as the distance from the top of the top line of the sign to the bottom of the last line of the sign. This also applies to the maximum vertical distance of sign artwork to include logo/signatures, copy, etc.
4. Copy application must be achieved by screen process or cut-out lettering appliqué only.
5. Reference is made within the text of these Standards to the term “corporate signature”. This is defined as the company’s name in recognized style and form, and/or the company’s logo.

Acceptable Materials

1. Porcelain enamel on aluminum or aluminized sheet steel
2. Anodized aluminum
3. Paint on aluminum—paint must be linear polyurethane for all under coats and top coats
4. Acrylic and fiberglass with satin finish only

The materials listed above are not acceptable for illuminated signs.

Unacceptable Materials

1. Rustic, unfinished or distressed wood
2. Rustic stone or brick
3. Plastic
4. Any oxidizing metal
5. Clay
6. Simulated or faux finish



Figure 2a: Capital height

Fabrication & Installation

The fabrication and installation of all signs will be of a permanent nature using established methods and quality materials and hardware. Only high quality workmanship performed by qualified tradespeople will be permitted.

Attachment hardware and connections of all signs must be non-corrosive and engineered to insure public safety.

Fabrication and installation must comply with all applicable City of Los Angeles Building and Sign Codes.

Maintenance

Tenants must maintain each approved sign in a neat, clean, orderly and safe manner. Failure to maintain an approved sign will result in revocation of approval and subsequent removal.

LAWA Standard Fonts

Exterior Signage

The LAWA approved font for exterior signs at Los Angeles International (LAX), Van Nuys (VNY), and Palmdale Regional (PMD) Airports is Franklin Gothic Demi. The approved font for Ontario International Airport (ONT) is Helvetica Bold Condensed.

Interior Signage

Helvetica Medium is the font standard for interior wayfinding signs for all airports under LAWA jurisdiction.

The approved fonts should be used as the default typefaces respectively for all directional and secondary text on signage where the tenant's corporate font is not used.

Franklin Gothic Demi

abcdefghijklmnopqrstuvwxy 0123456789
ABCDEFGHIJKLMN OPQRSTUVWXYZ [!@#\$%^&*(")?]

Helvetica Bold Condensed

abcdefghijklmnopqrstuvwxy 0123456789
ABCDEFGHIJKLMN OPQRSTUVWXYZ [!@#\$%^&*(")?]

Helvetica Medium

abcdefghijklmnopqrstuvwxy 0123456789
ABCDEFGHIJKLMN OPQRSTUVWXYZ [!@#\$%^&*(")?]

Figure 2b: The LAWA approved fonts.

Applicable Code Requirements

The tenant will have sole responsibility for compliance with all applicable federal, state, and local building codes, ordinances and other jurisdictional regulations including, but not limited to, the following:

- a) City of Los Angeles Department of Building & Safety
- b) City of Los Angeles Fire Department
- c) Los Angeles County Department of Health Services
- d) City of Los Angeles Department of Public Works
- e) City of Los Angeles Cultural Affairs Department
- f) Regional Water Quality Control Board
- g) SBC Communications
- h) Southern California Gas Company
- i) California Occupational Safety and Health Administration (CALOSHA).

Access for the disabled will be provided, as required by the City of Los Angeles, Title 24 of the California Administrative Code, the Americans with Disabilities Act of 1990, and any and all other applicable statutes, rules, regulations, codes and ordinances.

The tenant will be responsible for submitting the construction documents to the City of Los Angeles Department of Building and Safety and other jurisdictional agencies for plan check review and approval and for securing all the necessary building permits.

ADA Code Requirements

All tenants are required by law to adhere to the most current Americans with Disabilities Act (ADA) guidelines. The guidelines define four categories of interior and exterior signs:

1. Permanent Room Designation Signs

“Signs which designate permanent rooms and spaces” whose designation will not change, must comply with the highest standards. This includes tactile and Braille lettering raised at least 1/32” from the plaque surface. They must use exclusively, upper case characters of at least 5/8” cap height, but not exceeding 2” cap height. Typestyle will be “sans serif” or “simple serif”. Characters must have a width-to-height ratio of between 3:5 and 1:1, and a stroke width-to-height ratio of between 1:5 and 1:10. The use of pictograms or symbols on permanent room designation signs is optional, but where used they must be located on a border or field of at least 6” in height. An equivalent Grade 2 Braille and tactile written description must be placed directly below the symbol (with the exception of arrows) and may not intrude into the 6” field specified above. Characters and background must be eggshell, matte or other non-glare finish, which is recommended as between 11 and 19 degrees on a 60-degree glossimeter. Characters are recommended to have a minimum 70% reflectance contrast with their background.

2. Overhead Signs

Signs that are “protected or suspended overhead” including hanging or “flag” mounted signs must meet requirements for clearance, character proportion and height, sign finish and contrast.

They may use upper and lower case characters, cap height must be 3” minimum, and there must be at least 80” of clearance below the bottom of the sign.

3. Directional and Informational Signs

Wall mounted “signs which provide direction to or information about functional spaces” are not required to have tactile and Braille lettering. However, they must meet requirements for character proportion, sign finish and contrast. They may use upper and lower case characters. The cap height is not specified, but “characters and numbers on signs will be sized according to the viewing distance from which they are to be read”.

4. Temporary Information Signs

“Building directories, menus and all other signs that provide temporary information about rooms and spaces, such as the current occupant’s name, are not required to comply” with the guidelines.

5. Exterior Signs

The requirements for exterior and interior signs are generally the same. Most exterior signs are not required to have tactile and Braille lettering—other than in the situation where a sign is provided to designate a permanent room, such as a bathroom which is directly accessed from the outside. However, exterior signs must meet requirements for character proportion, sign finish, and contrast. They may use upper and lower case characters. Similarly, all of the conditions affecting overhead signs and protruding objects described in this section should be observed.

Regulation Enforcement

All tenants must obtain the written approval of LAWA for each sign. Any sign installed without the written approval of LAWA will be removed.

Upon notification of the demand to remove a non-conforming or non-permitted sign, the tenant must

- remove a permanent sign within 14 days
- remove a temporary sign within 5 days.

If the tenant does not remove the sign in the allotted time, LAWA will remove it and any expenses for this service will be paid by the tenant.

As already stated, previously approved existing signs that do not conform to these Standards will be allowed to remain installed. However, if there is to be a change, modification, renovation or relocation in any way involving previously approved and installed signage, LAWA will require that this signage be upgraded to conform to the current Standards.

Tenants may change or alter an existing permanent sign only with the written approval of LAWA. Any sign modifications will be the responsibility of the tenant. If leasehold improvement is modified, LAWA will require the signage to conform to the current sign codes.

All tenant signs are subject to discretionary periodic reviews by LAWA.

Alliances, Partnerships and Code Share Signs

To address the impact of airline alliances to airport signage, LAWA has established standards for the display of sub-tenant identification. Alliance graphics will be limited to corporate signatures, subordinate and adjacent to the primary tenant's signature sign.

Alliance signs may be ganged or grouped beside primary tenant signs and may not exceed the approved primary corporate identity sizes. Alliance signs are permissible in most areas where primary tenant identity signs are displayed, at the discretionary approval of LAWA.

All alliance signs must meet or exceed the regulations set out in these Standards for materials, fabrication and installation. Tenants may only display code share signs after submittal to—and approval by—LAWA for each sign. Airlines listed on the alliance signs must have an operating permit and current base with LAWA.

Refer to the Airline Alliance information in the Terminal Signs section for details.

LAWA Wayfinding Signs

Airport wayfinding signs are the sole jurisdiction of LAWA. Included in this sign category are roadway signs, parking structure signs, terminal under-canopy signs located along the upper and lower level curbsides, the interior terminal wayfinding signs and directional signs in public buildings controlled by the airport authority. All exterior wayfinding signs at LAX are limited to the generic LAWA font, Franklin Gothic Demi. All interior wayfinding signs and identification signs for TDD stations, telephones, AED units, etc. are limited to the Helvetica Font. No logos or graphics will be displayed on LAWA wayfinding signs.

Roadway and terminal under-canopy signs are restricted to airline names; where appropriate, an airline may be designated as an “International” carrier if operating both domestic and international flights. Designations not permitted on roadway and terminal signs include such terminology such as “First Class,” “Business Class,” “Group Check-In,” “Gold Member,” “Platinum Member,” “Executive Class,” “Economy Class,” etc. All designations are the sole discretion of LAWA.

Where possible, each airline will be given its own sign can in front of the terminal in which it operates. When space is at a premium, it is LAWA’s discretion to determine how best to utilize the space available. Tenants may request directional text for display on LAWA’s interior directional signs. Terminology is limited to text directing travelers to ticketing, the boarding gates, facilities and services offered to the public. Individual concessions or airline names are not displayed on terminal wayfinding signs.

U.S. Customs Signage Guidelines

Signage in the Federal Inspection Service Area (FIS) in Terminals 2, 6 and the Tom Bradley International Terminal is the responsibility of Los Angeles World Airports. Signage in Federal Inspection Service Areas in Terminals 4 and 5 is the responsibility of the Airline Tenants.

All signage in the Federal Inspection Service Areas are mandated to strictly adhere to U.S. Customs and Border Protection signage guidelines for verbiage, colors and sign specifications and can be found in the CBP signage manual.

All signage in the Federal Inspection Service Areas must be generic in nature. References to the U.S. Department of Agriculture, U.S. Department of Immigration and U.S. Customs Department must be removed since they exist under the umbrella of one government agency.

Informational Signs Not Related to Construction

Temporary signs may only be displayed after submittal to—and approval by—LAWA. The following requirements apply to all types and conditions of temporary signs.

Terms and Conditions

1. All signs are subject to approval on a case-by-case basis prior to fabrication.
2. Approval to display is based on the proposed location and intent with a limited time permit.
3. Approved temporary signs may be visible for a term not to exceed 45 days.
4. Sign content is restricted to information only. No advertising allowed.
5. Submittals must include scaled dimensioned drawings indicating copy, colors, fabrication method and materials, and a location map.

All submittals are due a minimum of 14 days prior to fabrication. Submit to:

Signage and Graphics Manager
Los Angeles World Airports
Planning and Development Group
6053 W. Century Blvd., Suite 603
Los Angeles, CA 90045

Temporary Sign Requirements During Construction

General

Construction activity can create very complex navigational challenges for the passenger. Temporary signs may be necessary to safely and efficiently move passengers through the airport environment in affected areas. The primary goal of the temporary signs is to maintain the integrity of the wayfinding system.

It is important to have consistency between permanent and temporary signs. Temporary signs will be similar in appearance with the exception of fabrication materials and mounting methods. This process allows the signage system to maintain visual continuity, clear messaging, and a sense of permanence thus instilling confidence in the passengers as they find their way through the airport. The PDG Sign Shop will design and produce all temporary wayfinding signage necessary during construction and/or as a result of construction as an interim solution to a forthcoming permanent plan.

Ordering Signs

Three weeks prior to the start of any project, a barricade and temporary signage site walk shall take place in order to determine necessary signage that may be needed during construction. Based on the site walk the PDG Sign Shop will then:

- Draft a Sign Plan
- Distribute the Draft Sign Plan to the Project Manager, Airport Operations Zone Manager and any necessary stakeholders for review and comment

- Schedule any follow-up site walks as needed to verify sign plan in the field
- Schedule site walk for future phases
- Revise and resubmit Sign Plan
- Produce Signs
- Schedule Installation or Delivery

To schedule a Site Walk contact Angela Flores at Aflores@lawa.org
424-646-7086 (desk)
310-776-0871 (cell)

Installing Signs

Whenever possible, the PDG Sign Shop will install the signs. However, due to project timing, sign locations or necessary mounting methods, some signs will require installation by the contractor. The signs and sign placement plan will be provided to the contractor for such instances.

Sign Holders

Appropriate sign holders such as A-frames and stanchion frames will be provided along with temporary signs as necessary. Sign holders shall be placed in accordance with the approved sign plan and must be returned once the detour is no longer in affect.

Maintenance of Signs and Sign Holders

The PDG Sign Shop is responsible for maintaining all temporary signs and sign holders for the duration of the project. The contractor is responsible for reporting any defaced, damaged or missing signs or sign holders to the PDG Sign Shop. All signs and sign holders must be returned to the PDG Sign Shop when the project or associated phase of the project is completed.

The PDG Sign Shop is located at 8100 Westchester Pkwy, Trailer 3 and can be reached by contacting Mark Henry at Mhenry@lawa.org
424-646-7167 (desk)
602-501-8376 (cell)

Project Identification Sign

One 12” x 12” project identification sign shall be placed on every construction entrance in public areas. Only one sign is needed on a set of double doors. All other regulatory signs shall be placed on the inside of the work area.

These signs will be provided by the PDG Sign Shop based on the barricade plan or site walk. Additional or replacement signs are available upon request.

The sign shall have the following information (See sample image below):

- CAUTION
- Construction Area
- Authorized Personnel Only
- Project Title
- Contractor name
- Contractor logo
- Contractor phone number



Promotional Signs

Contractor and their sub-contractors shall not display company signs and logos in public areas.

Coming Soon Graphics

The LAWA Project Manager will notify the Contractor of any Airport approved graphics and messaging other than wayfinding required for placement along the barricades and/or fencing during construction.

Prohibited Signs

The following signs and sign material are not permitted and may not be displayed on a temporary basis:

- Paper, poster or foam board signs
- Hand-written signs
- Paper banners
- Signs not approved by the LAWA Project Manager
- Vertical lettered signs
- Sign mounted using visible tape

Acceptable Caution and Warning Signs

In addition to one 12” x 12 project identification sign, upon occasion, it may be necessary to post signage on the public facing side of barricading or doors for public safety. When it is necessary to advise the public of a potential safety hazard such as welding, laser in use, and/or powder actuated tools in use, please notify the PDG Sign Shop in advance of these activities for temporary warning signage.

Signs not produced or installed by the PDG Sign Shop

The PDG Sign Shop does not produce or install the following types of signs:

- Permanent signs
- Roadway traffic detour signs
- Backlit signs
- Signs requiring electricity
- Taxiway signs
- Runway signs
- Braille signs
- Non-PDG project related signs
- Contractor signage (OSHA requirements, safety rules, etc.,)

Terminal Signs



*Los Angeles
World Airports*

Los Angeles International Airport



Description

Tenant corporate signature signs will be permitted on jetway walls as permanently mounted panels.

Location

- A primary signature sign panel may be attached to the exterior jetway wall section closest to the aircraft. Sign panel position is horizontally centered and 6 inches above center vertically.
- Sign must be installed a minimum of 4 feet away from support yokes, power cabinets, or hydraulics and will not interfere with the mechanical, electrical or physical operation of jetway.
- No signs are permitted on top or below the jetway, on pivot unit or operator station.

Sign Size

The maximum panel dimensions are 8 feet square (8' x 8') and not more than 2 inches thick.

Image & Text Size

Image is limited to the corporate signature only; no additional copy, slogans or information.

Colors & Fonts

The image and text of the corporate signature colors only are permitted.

Materials

Sign construction is limited to a metal panel with painted or silkscreened graphics. No dimensional elements, illumination, windows, frames, attachments or cutouts are permitted. Fixture by concealed mechanical fasteners.

Quantity

One (1) sign is permitted per jetway side. Maximum total is 2 signs on each jetway.

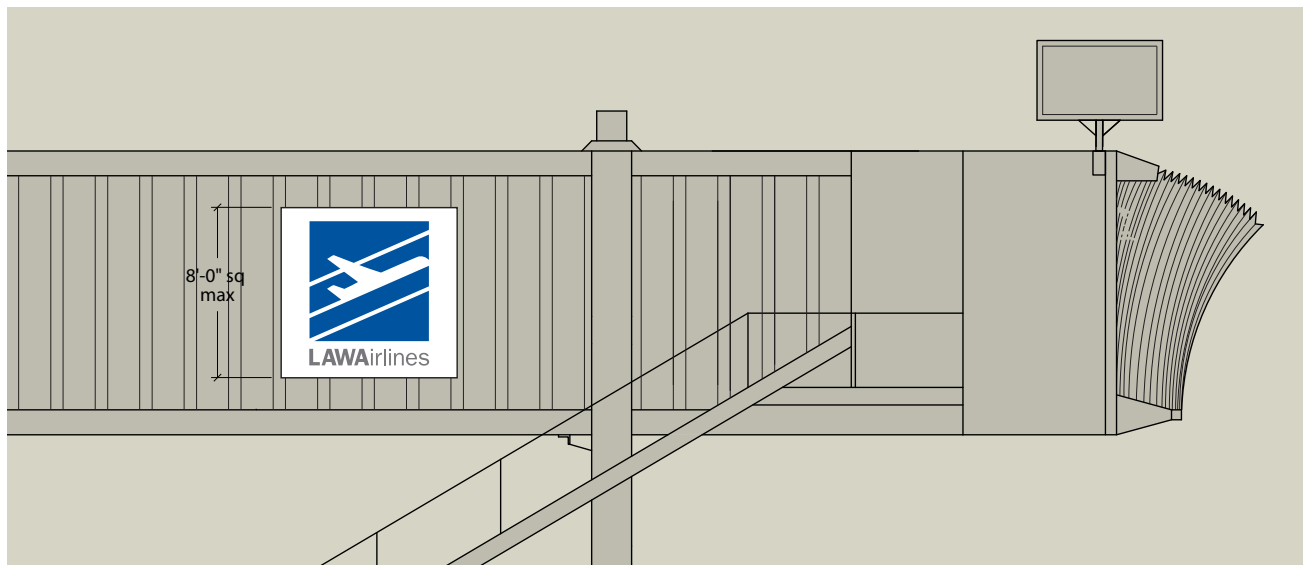

Figure 3a: Corporate signature panel sign on jetway exterior wall.

Description

Tenant corporate signature signs will be permitted on curbside check-in counters.

Location

- 1 A primary signature sign may be attached to the check-in counter. No signs permitted on walls, sidewalks, systems, or housings.
- 2 A secondary stanchion sign is permitted at the head of a queuing line.

Sign Size

- 1 The primary signature sign will be a maximum panel size of 3 feet, 6 inches wide by 18 inches high.
- 2 The stanchion top sign will be framed and firmly attached to the stanchion post top only. Maximum dimensions are 14 inches by 18 inches.

Image & Text Size

- 1 The combined letter area and logo height is not to exceed 6 inches and will fit comfortably within the sign panel.

- 2 The corporate signature and accompanying text will fit comfortably within a panel sign. Text will not exceed a maximum capital height of 6 inches. A minimum 1-inch edge margin will be maintained around the copy.

Colors & Fonts

- 1 The colors and fonts of the corporate signature are acceptable. Text should follow the tenant's corporate guidelines or use the LAX exterior wayfinding font.
- 2 The colors and fonts of the corporate signature are acceptable. Text should follow the tenant's corporate guidelines or use the LAX wayfinding font.

Materials

- 1 The sign panel will be painted aluminum or acrylic with screened or vinyl copy.
- 2 Standard frame as provided by manufacturer.

Quantity

- 1 2 One (1) per check-in position.

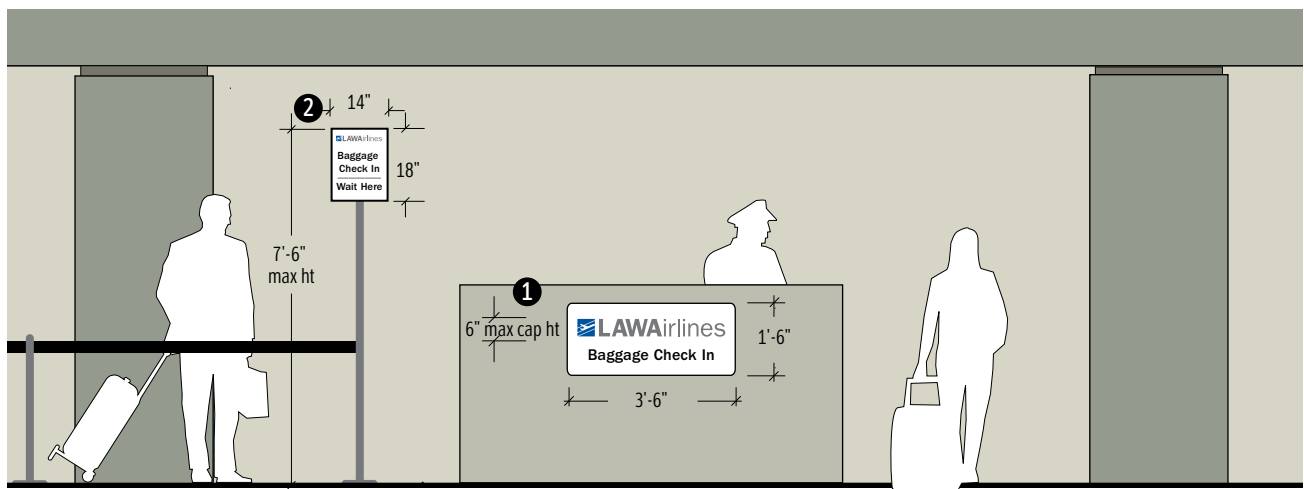

Figure 3b: Curbside identification signs showing tenant corporate signature and LAX standard font Franklin Gothic Demi

Description

Airline alliance tenant signature signs will be permitted on curbside check-in counters.

Location

A signature sign may be attached to the check-in counter. Multiple panels will be displayed in one line below the primary tenant sign. No signs permitted on walls, sidewalks, conveyor systems, or housings.

Sign Size

The airline alliance signature sign will be a maximum panel size of 3 feet, 6 inches wide by 9 inches high.

Image & Text Size

The maximum combined letter and logo height per airline name will not exceed 1 inch. Names will be flush left columns. A minimum 1-inch edge margin will be maintained around the copy on the panel.

Colors & Fonts

The colors and fonts of the corporate signature are acceptable. Text should follow the tenant's corporate guidelines or use the LAX exterior wayfinding font.

Materials

The sign panel will be painted aluminum or acrylic with screened or vinyl copy.

Quantity

One (1) per check-in position.

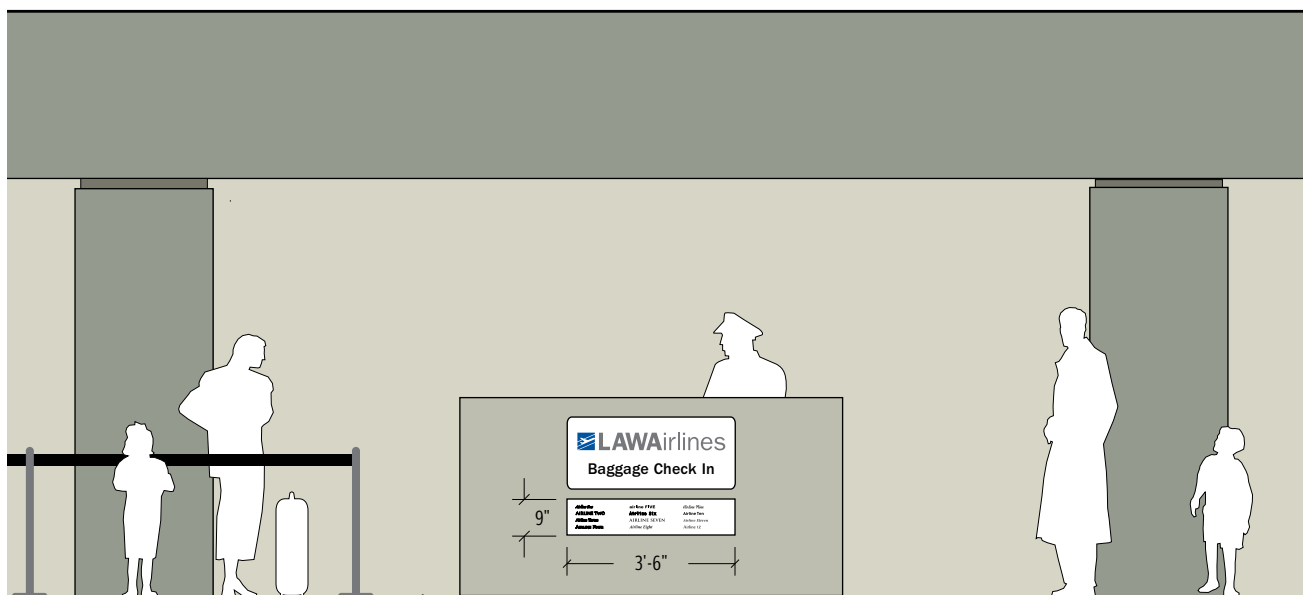

Figure 30: Airline alliance identity sign on the baggage check-in counter.

Description

Tenant corporate signature signs may be displayed on the wall behind the ticket counter. Non-standard sign types, (e.g., edge-lit or back washed illumination) as well as wall treatments (subdued graphics, wall textures) are acceptable with approval.

Location

The signature sign will be centered vertically over the counter space on the wall directly behind the counter.

Sign Size

The total length will not exceed 75% of the length of the lease line.

Image & Text Size

The preferred sign is an individually mounted dimensional tenant corporate signature with a logo/logotype maximum height of 18 inches.

Colors & Fonts

The colors and fonts of the corporate signature are acceptable. The finish and illumination must match or exceed LAWA signage standards.

Materials

Acceptable materials are painted aluminum or acrylic.

Quantity

One (1) sign is permitted for each 25 feet of the lease line.



Figure 3c: Dimensional copy is the preferred treatment for corporate signature signs on walls behind ticket counters.

Description

Airline alliance signature sign panels listing airlines that have an operating permit and current base with LAWA is permitted in the baggage service office area. As an alternate, airline alliance corporate signatures may be fabricated as dimensional graphics.

Location

All airline alliance signs will be installed to the side of the primary tenant identity sign on the wall directly behind the counter. No alliance sign will be displayed apart or separate from the primary tenant sign.

Sign Size

The airline alliance sign panel will be a maximum height of 18 inches and not more than 1 inch thick.

Image & Text Size

The maximum combined letter and logo height per airline name will not exceed 1 inch. Names will be flush left columns. A minimum 1-inch edge margin will be maintained around the copy on the panel.

Colors & Fonts

The colors and fonts of the corporate signature are acceptable. The finish must match or exceed LAWA signage standards.

Materials

Acceptable materials are painted aluminum or acrylic with screened or vinyl graphics. Internal illumination of alliance signs is not permitted.

Quantity

One (1) airline alliance tenant sign is permitted for each primary corporate signature sign per 25 feet of the lease line.

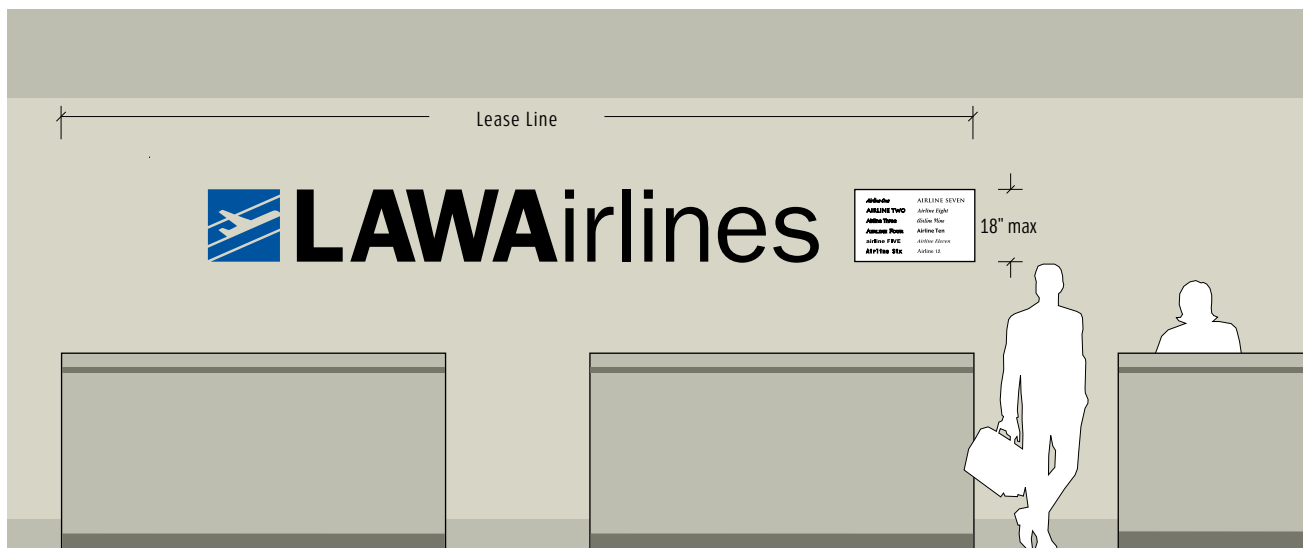

Figure 3p: Alliance identity signs beside the primary tenant's corporate signature sign behind the ticketing counter.

Description

A tenant corporate signature may be affixed to the structure surrounding a ticket kiosk when a kiosk is installed away from the primary ticketing area.

Location

The corporate signature will be vertically and horizontally centered on the customer side of the kiosk. No signs are permitted on the back or sides of the monitor or its cabinet.

Sign Size

The sign size will not exceed 75% of the total frontage area of the kiosk.

Image & Text Size

The combined letter area and logo height will not exceed 6 inches. A minimum 2-inch edge margin will be maintained around the signature.

Colors & Fonts

The image and text of the corporate signature will contrast with the kiosk background color. Fonts should follow the tenant's corporate standards or use the LAX interior wayfinding font.

Materials

The corporate signature will be reproduced as screened or vinyl graphics applied to the housing surface of the kiosk.

Quantity

One (1) sign per kiosk.

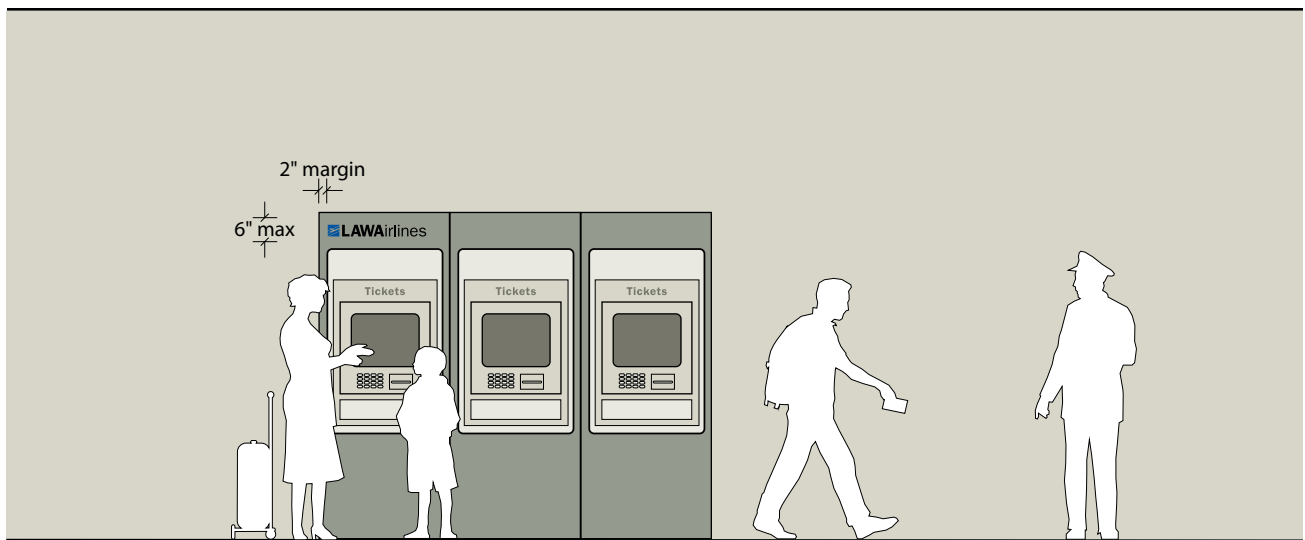

Figure 3d: Ticket kiosk with tenant signature sign.

Description

Queue area signs are permissible on queue ribbons and stanchion toppers in tenant leased spaces only.

Location

- 1 Stanchion top signs will be framed and firmly attached to the stanchion post top only. No queue area signs will be permitted on—or attached to—other surfaces including floors, walls, structural supports, columns, and ceilings.
- 2 Copy on queue ribbons will be printed graphics of one piece with the tape material. No signs will be attached to the ribbon.

Sign Size

- 1 Maximum frame dimensions are 14 inches wide by 18 inches high.
- 2 The corporate signature height will fit comfortably on the ribbon.

Image & Text Size

- 1 The corporate signature and accompanying text will fit comfortably within a panel sign. Text will not exceed a maximum capital height of 6 inches. A minimum 1-inch edge margin will be maintained around the copy.
- 2 The signature height will not exceed a minimum 1/4-inch edge margin above and below the copy.

Colors & Fonts

- 1 2 The image and text of the corporate signature colors are acceptable. Fonts should follow the tenant's corporate standards or use the LAX interior wayfinding font.

Materials

- 1 Standard frame as provided by manufacturer.
- 2 Screened copy on ribbon fabric.

Quantity

- 1 Maximum two (2) stanchion top signs at each queue position; one (1) per boarding zone lane.
- 2 One (1) signature per every 3 feet of ribbon.

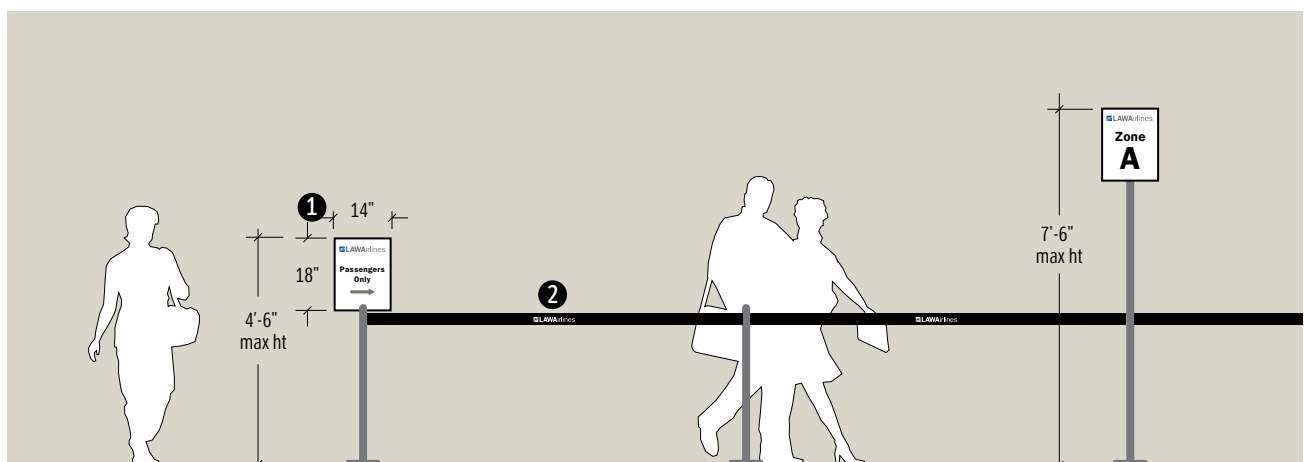

Figure 3e: Queue line tape and stanchion signs.

Description

Display signs consisting of the tenant's corporate signature and accompanying informational text will be permitted on ticket counters.

Location

Display signs will be displayed on service counters only. No display signs will be permitted on—or attached to—other surfaces including ticket kiosks, conveyor systems, housings, stanchions or structures.

Sign Size

Maximum dimensions are 12 inches by 14 inches.

Image & Text Size

The corporate signature and accompanying text will fit comfortably within a panel sign. Text will not exceed a maximum capital height of 6 inches. A minimum 1-inch edge margin will be maintained around the copy.

Colors & Fonts

The image and text of the corporate signature colors are acceptable. Fonts should follow the tenant's corporate standards or use the LAX interior wayfinding font.

Materials

Acceptable material is acrylic with screened or cut vinyl copy, acrylic frame or window with metal or plastic support.

Quantity

One (1) sign is permitted for each 15 feet of counter length.

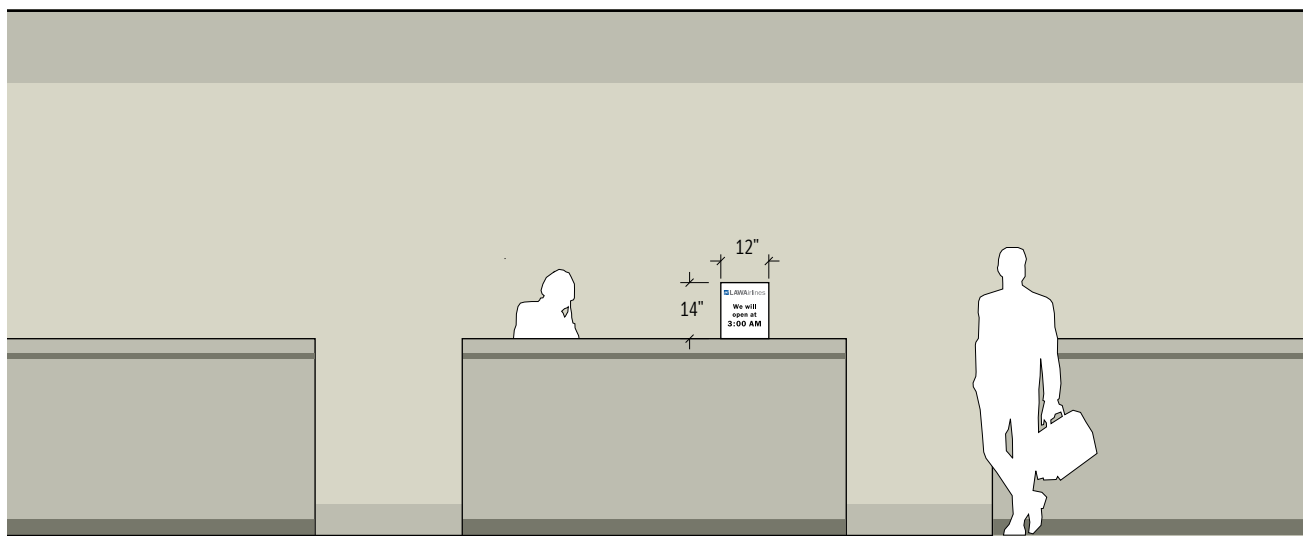

Figure 3f: Countertop informational sign.

Description

Informational signs consisting of the tenant's corporate signature and accompanying text will be permitted on luggage size check apparatus.

Location

The sign copy will be positioned on the customer sides of the device.

Sign Size

The sign size will not exceed 75% of the total frontage area of the apparatus. The luggage size check apparatus height will not be greater than 3 feet.

Image & Text Size

Copy will be limited to a corporate signature and minimal instructional text. No promotional or advertising copy or graphics will be allowed. The combined letter area and logo height will not exceed 6 inches. A minimum 1-inch edge margin will be maintained around the copy.

Colors & Fonts

The image and text of the corporate signature colors are acceptable. Fonts should follow the tenant's corporate standards or use the LAX interior wayfinding font.

Materials

Acceptable material is metal or acrylic with screened or cut vinyl copy.

Quantity

One (1) sign is permitted for each side of the device.

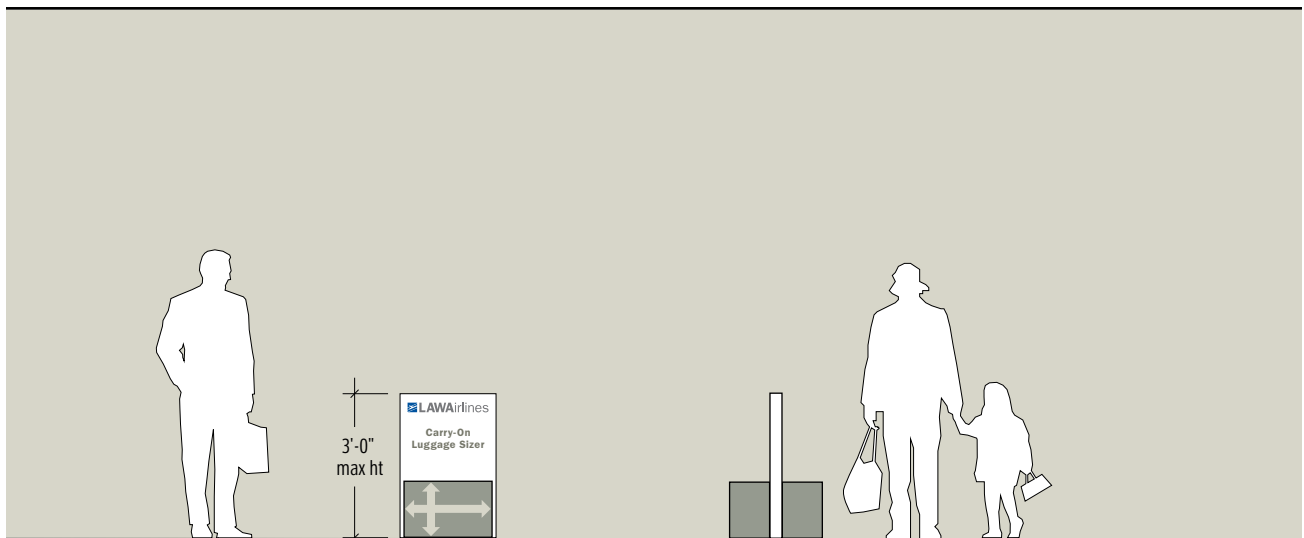

Figure 3g: Standard luggage sizers minimize clutter in the terminal.

Description

Tenant signature and informational signs are permitted in the boarding area. These signs will be reviewed by LAWA on a case-by-case basis. All signs will be of an informative nature designed to meet the needs of the traveling public. No promotional or advertising copy or graphics will be allowed.

- 1 If flight schedule monitors are provided by LAWA, electronic message displays will be controlled remotely from each gate podium by the airline agents.
- 2 Tenant corporate signature and informational signs may be attached to the structure surrounding the monitor.

Location

Signs are permitted within the tenant's own boarding area only. The preferred location is vertically centered on the wall directly behind the counter.

Sign Size

- 1 Determined by the monitor size.
- 2 The total sign size will not exceed 75% of the total frontage length of the counter.

1 2 See Figure 3h.

Image & Text Size

- 1 Image and text sizes will be determined by the monitor's capabilities.
- 2 Copy may consist of a corporate signature and flight information only. Copy will fit comfortably within the display area and may not encroach a minimum 2-inch edge margin.

Colors & Fonts

- 1 The image and text of the corporate signature colors are acceptable.
- 2 Informational text should follow the tenant's corporate font standards or use the LAWA approved interior wayfinding font. Informational text will appear in black or white only.

Materials

- 1 Determined by the monitor's display system.
- 2 Fixed signage will be permitted instead of the video monitor, as long as the signage does not extend beyond the intended video monitor display area. A fixed sign will be either screened or vinyl copy applied to an acrylic panel or other existing substrate.

Quantity

- 1 2 One (1) display sign per service position.

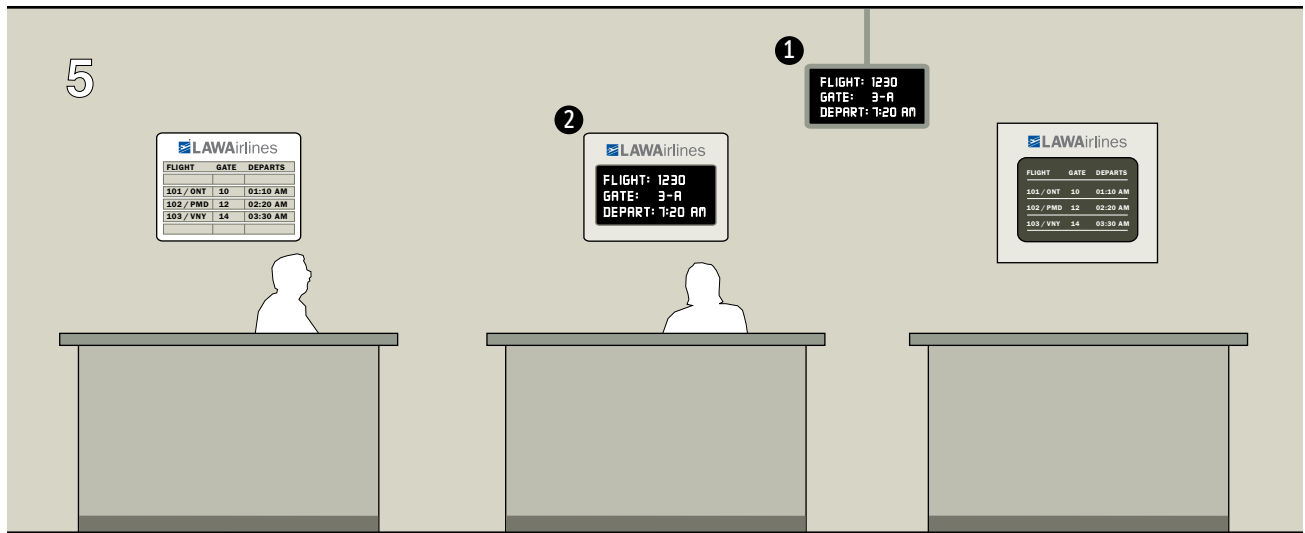

Figure 3h: Types of flight informational signs in the boarding area include static panels with changeable message strips and electronic display monitors.

Description

Tenant signature and informational signs are permitted in the baggage claim area.

- 1 Remotely controlled electronic LED displays will provide airline, flight number, and points of origin information. This signage may also include audio messaging capability to announce the displayed information.
- 2 Display signs consisting of the tenant's corporate signature and accompanying informational text only will be permitted on baggage carousel islands.

Location

Signage in the baggage claim area is limited to the LED monitors and the top of the carousel island. No signs will be attached to floors, walls, windows, conveyor systems, housings, freestanding stanchions or structures.

Sign Size

- 1 Message size is determined by the LED monitor.
- 2 The display sign will not exceed 4 feet by 3 feet in size. A double-sided panel or a four-sided cube will be allowed.

1 2 See Figure 3i.

Image & Text Size

- 1 Image and text sizes will be determined by the monitor's capabilities.
- 2 Copy will consist of a corporate signature and minimal informational text only. No promotional or advertising copy or graphics will be allowed. Copy will fit comfortably within the display area and may not encroach a minimum 2-inch edge margin.

Colors & Fonts

The image and text of the corporate signature colors are acceptable. Fonts should follow the tenant's corporate standards or use the LAX interior wayfinding font.

Materials

- 1 Determined by the monitor's display system.
- 2 Acceptable material is metal or acrylic with screened or applied cut vinyl copy.

Quantity

- 1 One (1) monitor per baggage carousel area.
- 2 One (1) sign per baggage carousel.

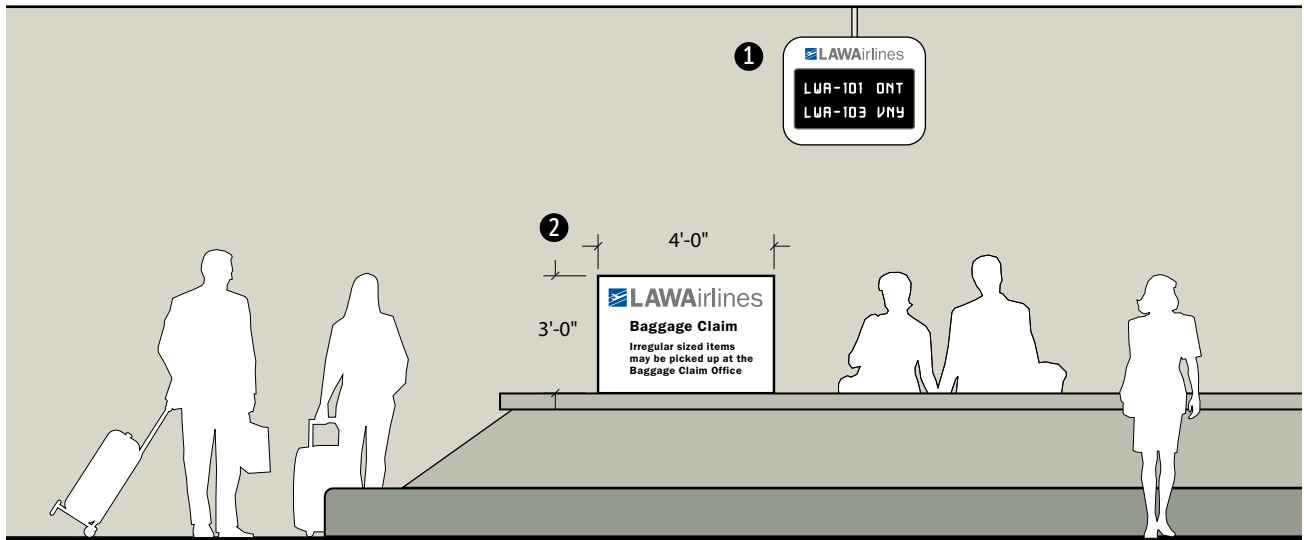

Figure 3i: Two standardized sign types help to minimize disorder in the baggage claim area.

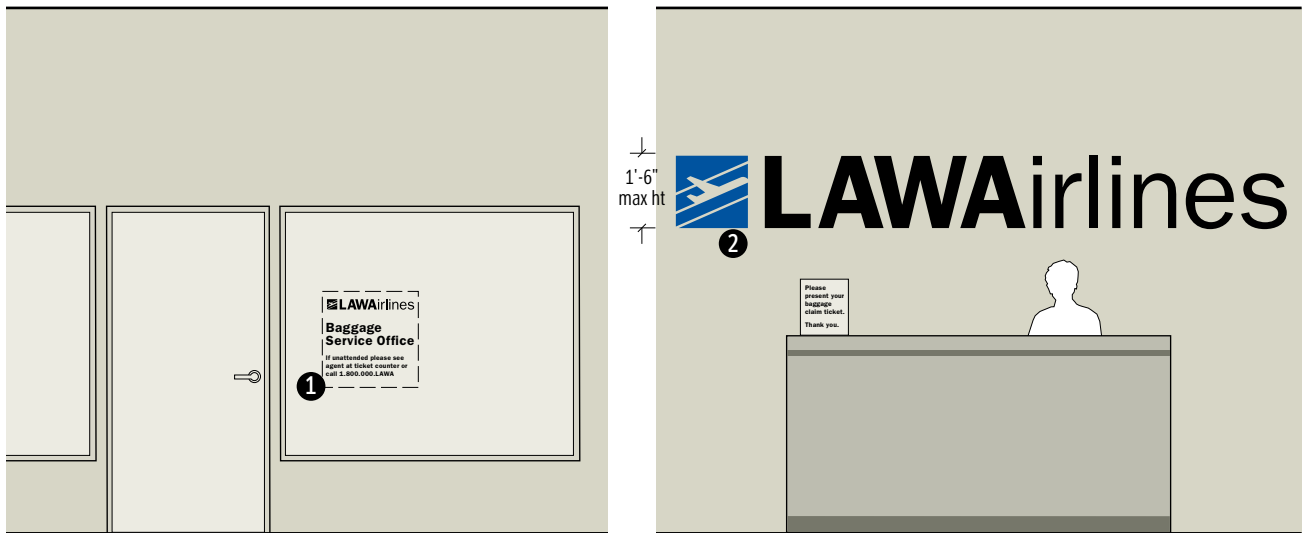

Figure 3j: An informational sign on the exterior window ① and a corporate signature sign ② inside the baggage service office.

Description

Tenant signature and informational signs are permitted in the baggage service office area. Signs within the office space will comply with the requirements and aesthetics of these Standards.

Location

- 1 An informational office sign may be located in the window adjacent to the entrance door.
- 2 A corporate signature sign may be attached to the wall directly behind the service counter. No signs will be attached to the exterior side of the window or adjacent surfaces.

Sign Size

- 1 The window sign must fit within a single area not to exceed 2 feet wide by 2 feet high.
- 2 The corporate signature sign will not exceed 75% of the length of the counter and a maximum height of 18 inches.

1 2 See Figure 3j.

Image & Text Size

- 1 Copy will be limited to the tenant's corporate signature and brief descriptive text such as "Baggage Services," phone numbers, hours, etc.
- 2 The office interior sign will be limited to the corporate signature and brief descriptive text such as "Baggage Services."

Colors & Fonts

The image and text of the corporate signature colors are acceptable. Informational text on the office window will be black or white only. Fonts should follow the tenant's corporate standards or use the LAX interior wayfinding font.

Materials

- 1 The affixed window sign will be either screened or vinyl graphics applied to the office interior side of the glass surface.
- 2 Corporate signature sign will be an acrylic panel or dimensional copy.

Quantity

- 1 One (1) informational window sign per office.
- 2 One (1) corporate signature sign per office.

Description

An airline alliance signature sign panel listing airlines that have an operating permit and current base with LAWA is permitted in the baggage service office area.

Location

An airline alliance sign panel will be installed to the side of the primary tenant identity sign on the wall directly behind the baggage service counter. No alliance sign will be displayed apart or separate from the primary tenant sign.

Sign Size

The airline alliance panel will be a maximum height of 18 inches and not more than 1 inch thick.

Image & Text Size

The maximum combined letter and logo height per airline name will not exceed 1 inch. Names will be flush left columns. A minimum 1-inch edge margin will be maintained around the copy on the panel.

Colors & Fonts

The colors and fonts of the corporate signature are acceptable. The finish must match or exceed LAWA signage standards.

Materials

Acceptable materials are painted aluminum or acrylic with screened or vinyl graphics. Internal illumination of alliance signs is not permitted.

Quantity

One (1) airline alliance panel sign per office.



Figure 3q: Airline alliance panel sign behind the service counter inside the primary tenant's baggage service office.

Description

A tenant corporate signature may be affixed to the structure surrounding an information display system.

Location

The corporate signature will be vertically and horizontally centered on the monitor housing above the video monitor. No signs are permitted on the sides of the monitor or its cabinet.

Sign Size

The sign size will not exceed 75% of the total area above the monitor.

Image & Text Size

The combined letter area and logo height will not exceed 6 inches. A minimum 2-inch edge margin will be maintained within the display area.

Colors & Fonts

The image and text of the corporate signature will contrast with the monitor cabinet color. Fonts should follow the tenant's corporate standards or use the LAX interior wayfinding font.

Materials

The corporate signature will be reproduced as screened or vinyl graphics applied to the housing surface of the monitor.

Quantity

One (1) sign per display system.

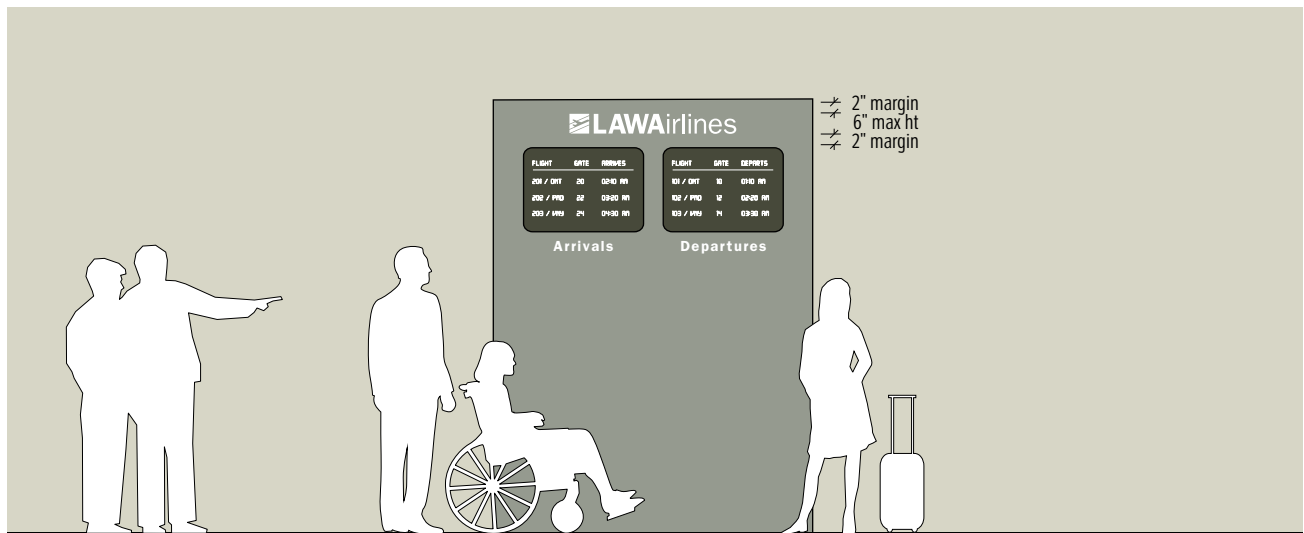

Figure 3k: Tenant corporate signature may be placed on the cabinet face of flight schedule monitors.

Description

Directional signs for tenant passenger lounges may be requested to LAWA for inclusion on terminal wayfinding signs. No other directional signs—freestanding or attached—are permitted.

Location

Directional text and arrow may be included on terminal wayfinding signs. No tenant logos or signatures are allowed. Placement of copy and graphics to be determined by LAWA.

Sign Size

Sign size will be determined by LAWA.

Image & Text Size

The combined letter and arrow height will be a maximum of 4 inches or as determined by LAWA.

Colors & Fonts

The image and text will follow LAWA’s standards for LAX wayfinding signage.

Materials

Sign materials will be consistent with LAWA’s standards for LAX wayfinding signage.

Quantity

As determined by LAWA according to lounge location, sign space availability and location of wayfinding directional signs.



Figure 31: Directions to tenant passenger lounges may appear on airport directional signs by request to LAWA.

Description

Passenger lounge identification signs are permitted at the entrance to the tenant's lounge.

Location

Lounge identification signs will be located on the entrance door or wall immediately adjacent to it. No signs are permitted on walkways, windows, corridor walls, freestanding stanchions or structures.

Sign Size

All signs must fit within a single area 2 feet wide by 2 feet high. ADA tactile and Braille copy are required. Whenever possible this sign will incorporate an entry push button or card key.

Image & Text Size

Copy will be limited to the tenant's corporate signature and brief descriptive text such as service hours, phone numbers, etc. Copy will fit comfortably within the display area and may not encroach a minimum 1-inch edge margin.

Colors & Fonts

The image and text of the corporate signature colors are acceptable. Fonts should follow the tenant's corporate standards or use the LAX interior wayfinding font. Informational text will be black or white only.

Materials

Acceptable materials are polished or brushed metal, painted aluminum or acrylic.

Quantity

One (1) sign per entrance.

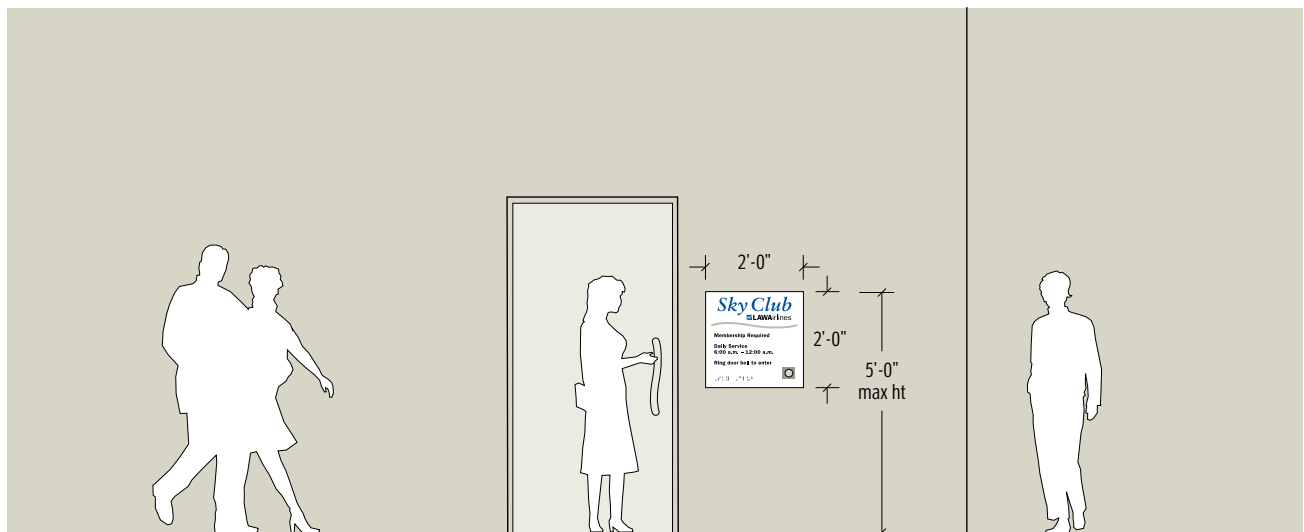

Figure 3m: Passenger lounge signs include ADA required tactile identification.

Description

Tenant identification may appear on room identification signs.

Location

A room identification sign is required at each doorway to tenant leased interior spaces.

Sign Size

The sign size will not exceed 8 inches by 10 inches.

Image & Text Size

Room identification signs must conform to all ADA and local code requirements for copy size and tactile messages.

Colors & Fonts

The colors and fonts of the corporate signature are acceptable. Informational text will be white or black only and use the fonts of the tenant's corporate guidelines or LAX interior wayfinding font. Tactile messages must conform to ADA requirements.

Materials

Acceptable materials are polished or brushed metal, painted aluminum or acrylic.

Quantity

One (1) sign per entrance.

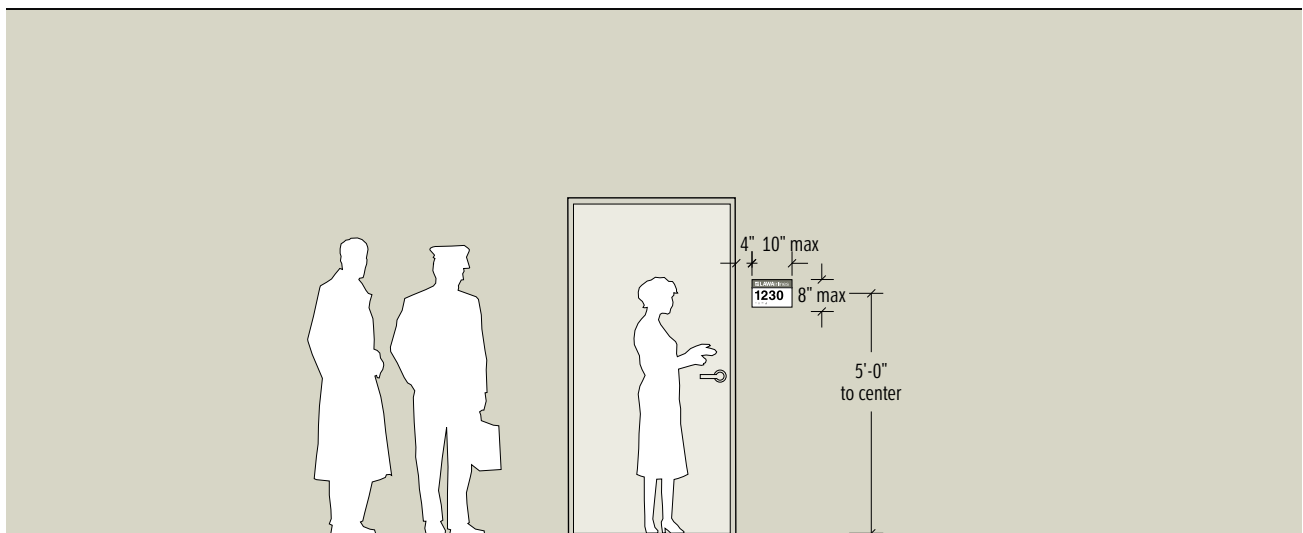

Figure 3n: Room identification signs which comply to ADA code standards are required by law.

Office & Warehouse Signs



*Los Angeles
World Airports*

Los Angeles International Airport



Exterior Signage

Tenant office and warehouse buildings under LAWA jurisdiction are subject to the following restrictions.

1. Architectural elements should be utilized for sign application when possible, i.e., header, soffit, fascia, parapet.
2. Where possible, signage to be positioned at parapet, but not to extend above or below.
3. All signs must be permanently mounted, using individual letters only.
4. Individually mounted, internally illuminated letters are required for master and sub-tenant signage.
5. Lettering is limited to corporate name or corporate name and “Express,” “Air Cargo,” “Air Freight” or “Transfer” provided that they are registered corporate identities.
6. Where possible, all sign information should be located above roll-up doors.
7. No signage is permitted on bay or roll-up doors.
8. All roll-up doors in bays must be the same color.
9. Bay identification number(s) will be allowed over each bay. The maximum height is 9 inches.
10. Signage mounted above a bay must be centered directly over the bay. Sign width cannot exceed the width of the bay.
11. When two or more bays are represented by the same sign, one sign will be centered between the two bays, if possible.
12. No temporary attachments will be permitted.
13. No stenciling will be permitted.
14. No internally illuminated can signs will be permitted.
15. No plaques or painted on numbers; numbers must be cut out, individually mounted.
16. No back washed, spot lighted, flashing, or animated signs are permitted.
17. No window signs will be permitted.
18. No roof signs or signs mounted on top of parapet will be permitted.
19. No vertically mounted lettering is permitted.
20. Signage may not violate an architectural feature or extend beyond a vertical architectural feature or fascia.
21. No signage on awnings or canopies is permitted.
22. No paper, handmade or hand lettered sign will be permitted.
23. If sign is positioned within 3 feet of architectural elements such as doors or windows, it must be centered over that element and may not extend above, below or cover it in any way.
24. Signs will not exceed the width of any vertical architectural element, wall, or façade exists.
25. “No Parking” signs may repeat where necessary, but must be located individually and may not overlap or extend on to any other signage or architectural feature.

Permitted Tenant Signs

Master tenant office and warehouse buildings may include a corporate signature sign and a regulatory or informational sign as needed (Figure 4a). Multiple tenant buildings with a master tenant and one or more sub-tenants may include a corporate signature sign and a regulatory or informational sign for each occupant. (Figure 4b). Refer to the Master Tenant and Sub-Tenant standards on the following pages for details.



Figure 4a: Master Tenant Building

- ① Primary master tenant corporate signature
- ② Secondary corporate signature with service text
- ③ Regulatory or informational sign

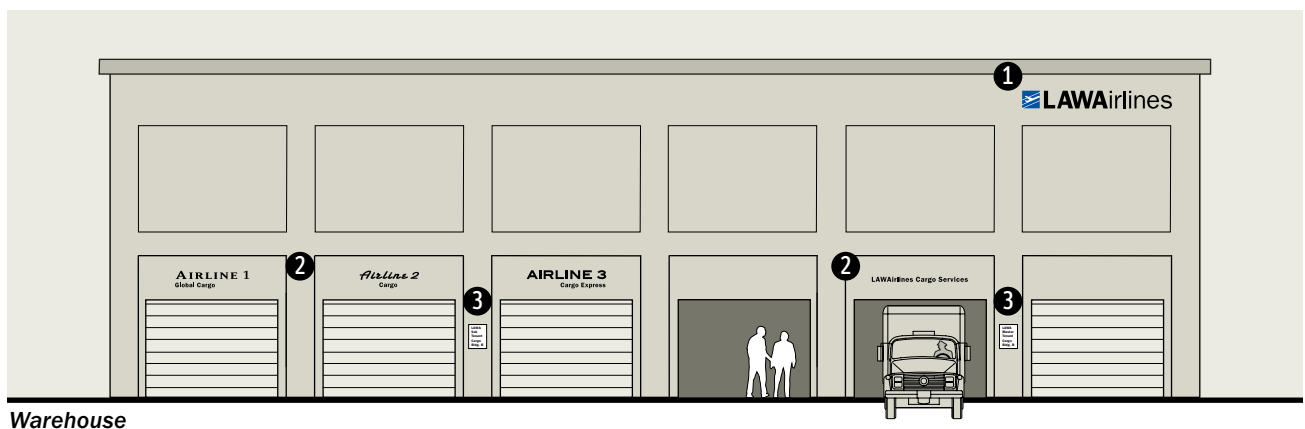

Figure 4b: Multiple Tenant Building

- ① Primary master tenant corporate signature
- ② Secondary corporate signature with service text; master tenant service sign
- ③ Regulatory or informational sign

Description

Corporate signature signs and a regulatory or informational sign are permitted on tenant office and warehouse buildings. These signs must be reviewed by LAWA on a case-by-case basis.

Location

- ❶ The master tenant's corporate signature sign may be placed on any side of the building. The sign must align with a vertical or horizontal architectural feature where possible.
- ❷ The tenant's corporate signature may be installed above a warehouse bay door.
- ❸ A regulatory or information sign is permitted as needed for building operations.

Sign Size

Refer to the master tenant building size diagrams in this section for visual reference.

- ❶ Refer to the Master Tenant Signature Sign Size chart in these Standards to determine primary corporate sign size. *(Figure 4e)*
- ❷ Tenant corporate signature signs above a bay door may not exceed 8 feet in width or the width of the bay door, whichever dimension is less. *(Figure 4e)*
- ❸ Tenant informational signs must not exceed 8 square feet in area.

❶❷❸ See Figures 4a, 4b, 4c.

Image & Text Size

- ❶❷ Refer to the Master Tenant Signature Sign Sizes chart in these Standards. *(Figure 4e)*
- ❸ Maximum capital height for regulatory or information signs is 6 inches. No corporate signature is allowed on this sign. *(Figure 4e)*

Colors & Fonts

The image and text of the corporate signature colors are acceptable. Fonts should follow the tenant's corporate standards or use the LAX exterior wayfinding font.

Materials

- ❶❷ Dimensional copy of fabricated aluminum and acrylic.
- ❸ See the approved materials list and general restrictions in these Standards.

Quantity

- ❶❷ A maximum of two (2) master tenant signature signs are permitted on each building. No more than one (1) per structure side.
- ❸ No more than one (1) per structure is permitted.

Master Tenant Buildings & Corporate Signature Signs

Building size and tenant status are the basic criteria for establishing the size of corporate signature signs. These diagrams and the following charts convey maximum sign sizes for buildings occupied by a single tenant.



Figure 4c: Building height and width determine the maximum sign size for corporate signatures.

Description

Corporate signature signs and a regulatory or informational sign are permitted for sub-tenants on office and warehouse buildings. These signs must be reviewed by LAWA on a case-by-case basis.

Location

- 1 The master tenant's corporate signature sign may be placed on any side of the building. The sign must align with a vertical or horizontal architectural feature where possible.
- 2 The sub-tenant's corporate signature may be installed at the office entrance and/or above a warehouse bay door.
- 3 A regulatory or information sign is permitted as needed for building operations.

Sign Size

Refer to the master tenant building size diagrams in this section for visual reference.

- 1 Refer to the Master Tenant Signature Sign Sizes chart in these Standards to determine primary corporate sign size. *(Figure 4e)*
- 2 Refer to the Sub-Tenant Signature Sign Sizes chart in these Standards to determine primary corporate sign size. *(Figure 4e)*
- 3 Tenant informational signs must not exceed 6 square feet in area.

1 2 3 See Figures 4a, 4b, 4d.

Image & Text Size

- 1 Refer to the Master Tenant Signature Sign Sizes chart in this section. *(Figure 4e)*
- 2 Refer to the Sub-Tenant Signature Sign Sizes chart in this section. *(Figure 4e)*
- 3 Maximum capital height for regulatory or information signs is 6 inches. No corporate signature is allowed on this sign.

Colors & Fonts

The image and text of the corporate signature colors are acceptable. Fonts should follow the tenant's corporate standards or use the LAX wayfinding font, Franklin Gothic Demi.

Materials

- 1 2 Dimensional copy of fabricated aluminum and acrylic.
- 3 See the approved materials list and general restrictions in these Standards.

Quantity

- 1 A maximum of two (2) master tenant signature signs are permitted on each building. No more than one (1) per structure side.
- 2 A maximum of two (2) sub-tenant signature signs are permitted on each building. No more than one (1) per structure side.
- 3 No more than one (1) informational sign per tenant is permitted on each structure side.

Multiple Tenant Buildings & Corporate Signature Signs

Building size and tenant status are the basic criteria for establishing the size of corporate signature signs. These diagrams and the following charts convey maximum sign sizes for buildings with more than one tenant.



Figure 4d: Building height and width determine the maximum sign size for corporate signatures.

Tenant Status & Corporate Signature Signs

Corporate signature sign dimensions are determined by building height/width measurements and tenant status. The primary corporate signature sign may never appear longer than one-third (1/3) the length of the building frontage or taller than the established maximum signature height indicated.

LAWA stipulations for master tenant and sub-tenant signs for office and warehouse buildings are indicated in the following charts.

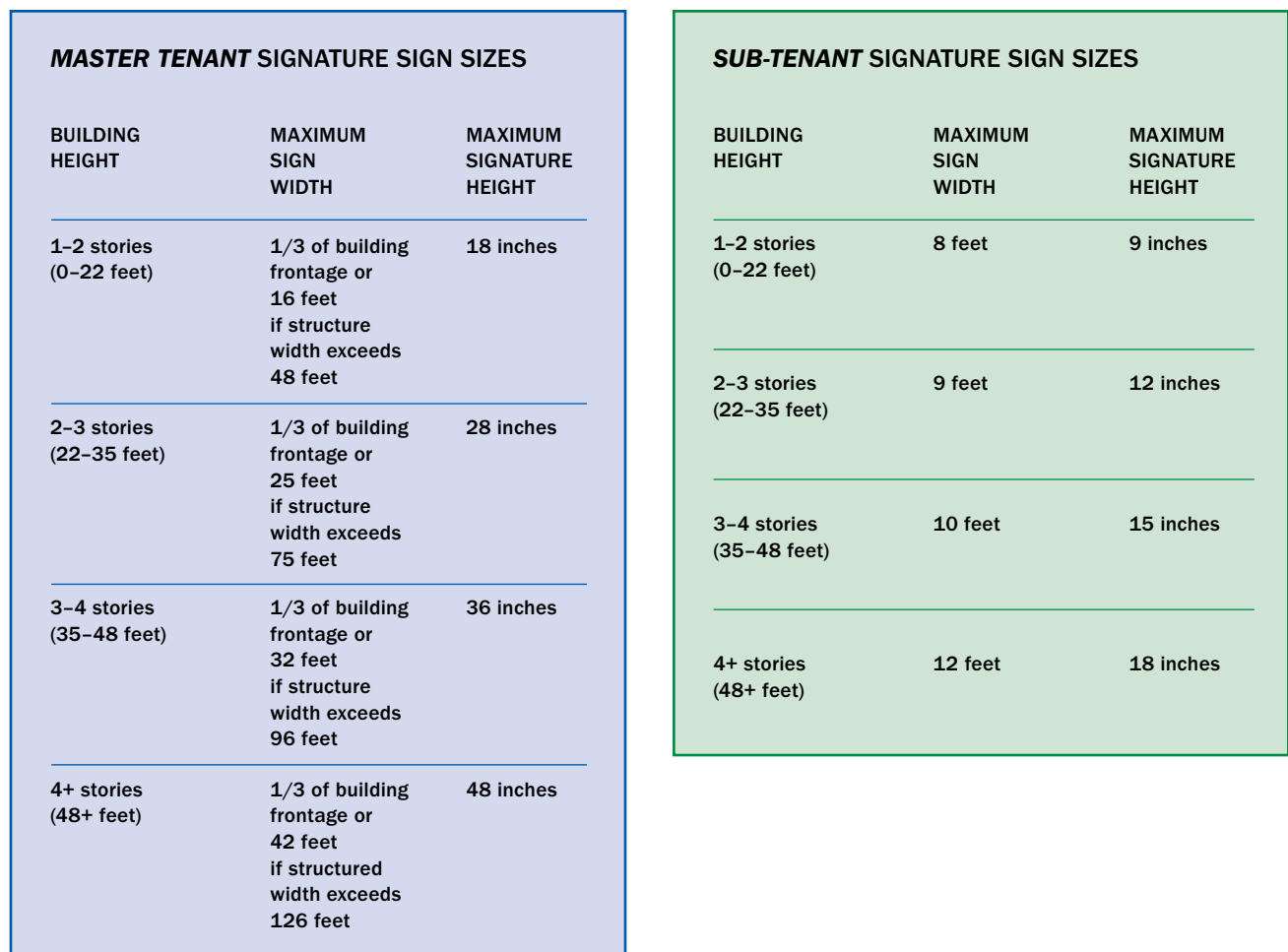

Figure 4e: Building size to corporate signature sign size specifications.

Hangar & Service Building Signs



*Los Angeles
World Airports*

Los Angeles International Airport



Exterior Signage

Hangars and service buildings under LAWA jurisdiction are subject to the following restrictions.

1. Architectural elements should be utilized for sign application when possible, i.e., header, soffit, fascia, parapet.
2. Where possible, signage to be positioned at parapet, but not to extend above or below.
3. All signs must be permanently mounted, using individual letters only.
4. Individually mounted, internally illuminated letters are required for master and sub-tenant signage.
5. Lettering is limited to corporate name or corporate name and “Express,” “Air Cargo,” “Air Freight” or “Transfer” provided that they are registered corporate identities.
6. Where possible, all sign information should be located above roll-up doors.
7. No signage is permitted on bay or roll-up doors.
8. All roll-up doors in bays must be the same color.
9. Bay identification number(s) will be allowed over each bay. The maximum height is 9 inches.
10. Signage mounted above a bay must be centered directly over the bay. Sign width cannot exceed the width of the bay.
11. When two or more bays are represented by the same sign, one sign will be centered between the two bays, if possible.
12. No temporary attachments will be permitted.
13. No stenciling will be permitted.
14. No internally illuminated can signs will be permitted.
15. No plaques or painted on numbers; numbers must be cut out, individually mounted.
16. No back washed, spot lighted, flashing, or animated signs are permitted.
17. No window signs will be permitted.
18. No roof signs or signs mounted on top of parapet will be permitted.
19. No vertically mounted lettering is permitted.
20. Signage may not violate an architectural feature or extend beyond a vertical architectural feature or fascia.
21. No signage on awnings or canopies is permitted.
22. No paper, handmade or hand lettered sign will be permitted.
23. If sign is positioned within 3 feet of architectural elements such as doors or windows, it must be centered over that element and may not extend above, below or cover it in any way.
24. Signs will not exceed the width of any vertical architectural element, wall, or façade exists.
25. “No Parking” signs may repeat where necessary, but must be located individually and may not overlap or extend on to any other signage or architectural feature.

Description

Corporate signature signs and a regulatory or informational sign are permitted on tenant hangars and service buildings. These signs will be reviewed by LAWA on a case-by-case basis.

Location

- 1 The master tenant's primary corporate signature sign may be placed on any side of the building. The sign must align with a vertical or horizontal architectural feature wherever possible.
- 2 A regulatory or information sign is permitted as needed for building operations.

Sign Size

Refer to the master tenant Building Sizes page in this section for visual reference.

- 1 Refer to the Master Tenant Sign Types diagrams and Master Tenant Signature Sign Sizes chart in this section.
- 2 Tenant informational signs must not exceed 8 square feet in area.

1 2 See *Figures 5a-d*.

Image & Text Size

- 1 Refer to the Master Tenant Sign Types diagrams and Master Tenant Signature Sign Sizes chart in this section.
- 2 Maximum capital height for regulatory or information signs is 6 inches. No corporate signature is allowed on this sign.

Colors & Fonts

The image and text of the corporate signature colors are acceptable. Fonts should follow the tenant's corporate standards or use the LAX wayfinding font, Franklin Gothic Demi.

Materials

- 1 Dimensional copy of fabricated aluminum and acrylic.
- 2 See approved materials list and general restrictions.

Quantity

- 1 A maximum of two (2) master tenant signature signs are permitted on each building. No more than one (1) per structure side.
- 2 No more than one (1) informational sign per structure side is permitted.

Master Tenant Structures & Corporate Signature Signs

Structure size and tenant status are the basic criteria for establishing the size of corporate signature signs.

These diagrams and the following charts convey maximum sign sizes for buildings occupied by a single tenant.

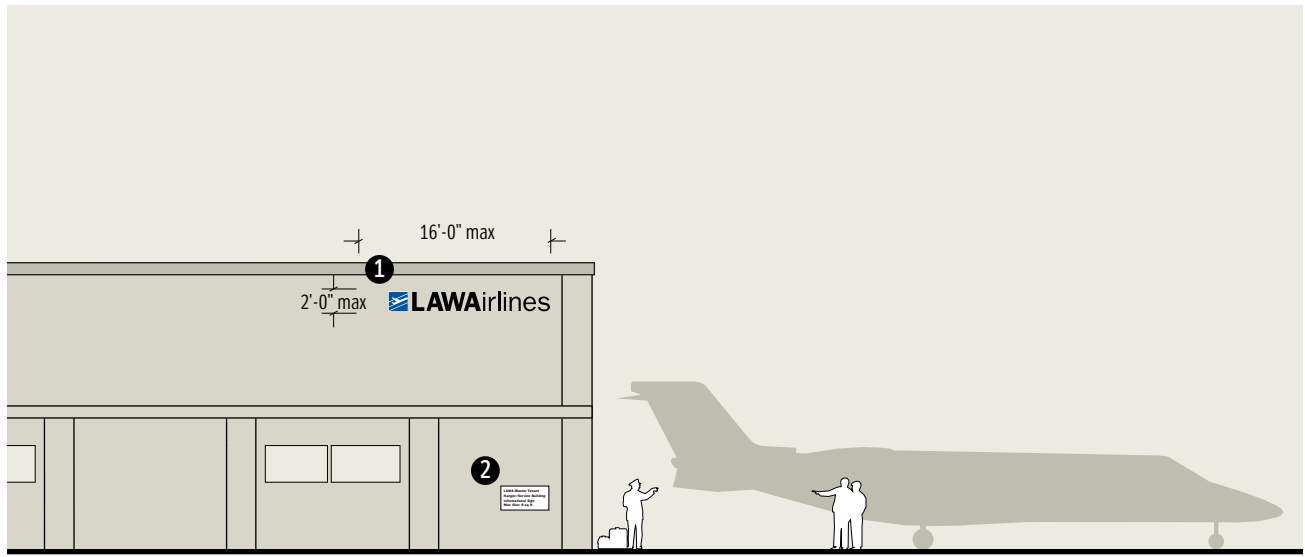

Figure 5a: Master Tenant Building

- ① Primary master tenant corporate signature for a structure up to 2 stories in height (22 feet)
- ② Regulatory or informational sign

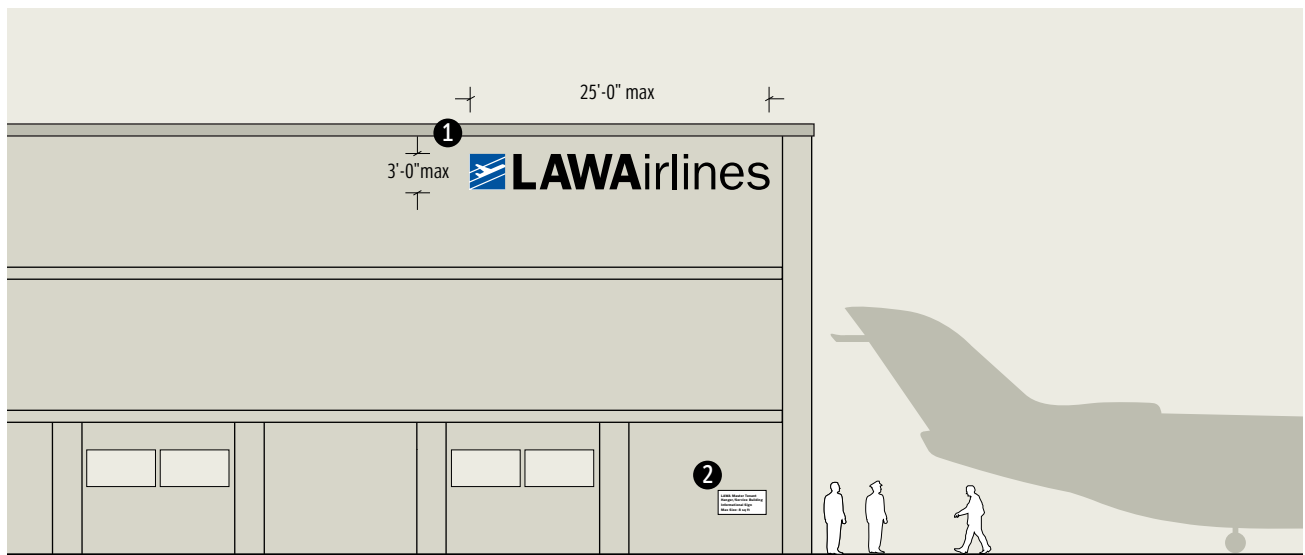

Figure 5b: Master Tenant Building

- ① Primary master tenant corporate signature for a structure up to 3 stories in height (35 feet)
- ② Regulatory or informational sign



Figure 5c: Master Tenant Building

- ① Primary master tenant corporate signature for a structure up to 4 stories in height (48 feet)
- ② Regulatory or informational sign



Figure 5d: Master Tenant Building

- ① Primary master tenant corporate signature for a structure greater than to 4 stories in height (48+ feet)
- ② Regulatory or informational sign

Description

Sub-tenants are permitted a corporate signature sign and a regulatory or information sign on tenant hangars and service buildings. These signs must be reviewed by LAWA on a case-by-case basis.

Location

- 1 A corporate signature sign may be placed on any side of the building. The sign must align with a vertical or horizontal architectural feature wherever possible.
- 2 A regulatory or information sign is permitted as needed for building operations.

Sign Size

- 1 Refer to the Sub-Tenant Sign Types diagrams and Sub-Tenant Signature Sign Sizes chart in this section.
- 2 Tenant informational signs must not exceed 8 square feet in area.

1 2 See Figures 5e-h.

Image & Text Size

- 1 2 Refer to the Sub-Tenant Sign Types diagrams and Sub-Tenant Signature Sign Sizes chart in this section.
- 3 Maximum capital height for regulatory or information signs is 6 inches. No corporate signature is allowed on this sign.

Colors & Fonts

The image and text of the corporate signature colors are acceptable. Fonts should follow the tenant's corporate standards or use the LAX exterior wayfinding font.

Materials

- 1 2 Dimensional copy of fabricated aluminum and acrylic.
- 3 See the approved materials list and general restrictions in these Standards.

Quantity

- 1 A maximum of two (2) master tenant signature signs are permitted on each building. No more than one (1) per structure side.
- 2 A maximum of two (2) sub-tenant signature signs are permitted on each building. No more than one per structure side.
- 3 No more than one (1) informational sign per tenant is permitted on each structure side.

Multiple Tenant Structures & Corporate Signature Signs

Structure size and tenant status are the basic criteria for establishing the size of corporate signature signs.

These diagrams and the following charts convey maximum sign sizes for buildings with more than one tenant.



Figure 5e: Multiple Tenant Building

- ① Primary master tenant corporate signature for a structure up to 2 stories in height (22 feet)
- ② Secondary corporate signature
- ③ Regulatory or informational sign



Figure 5f: Multiple Tenant Building

- ① Primary master tenant corporate signature for a structure up to 3 stories in height (35 feet)
- ② Secondary corporate signature
- ③ Regulatory or informational sign



Figure 5g: Multiple Tenant Building

- ① Primary master tenant corporate signature for a structure up to 4 stories in height (48 feet)
- ② Secondary corporate signature
- ③ Regulatory or informational sign

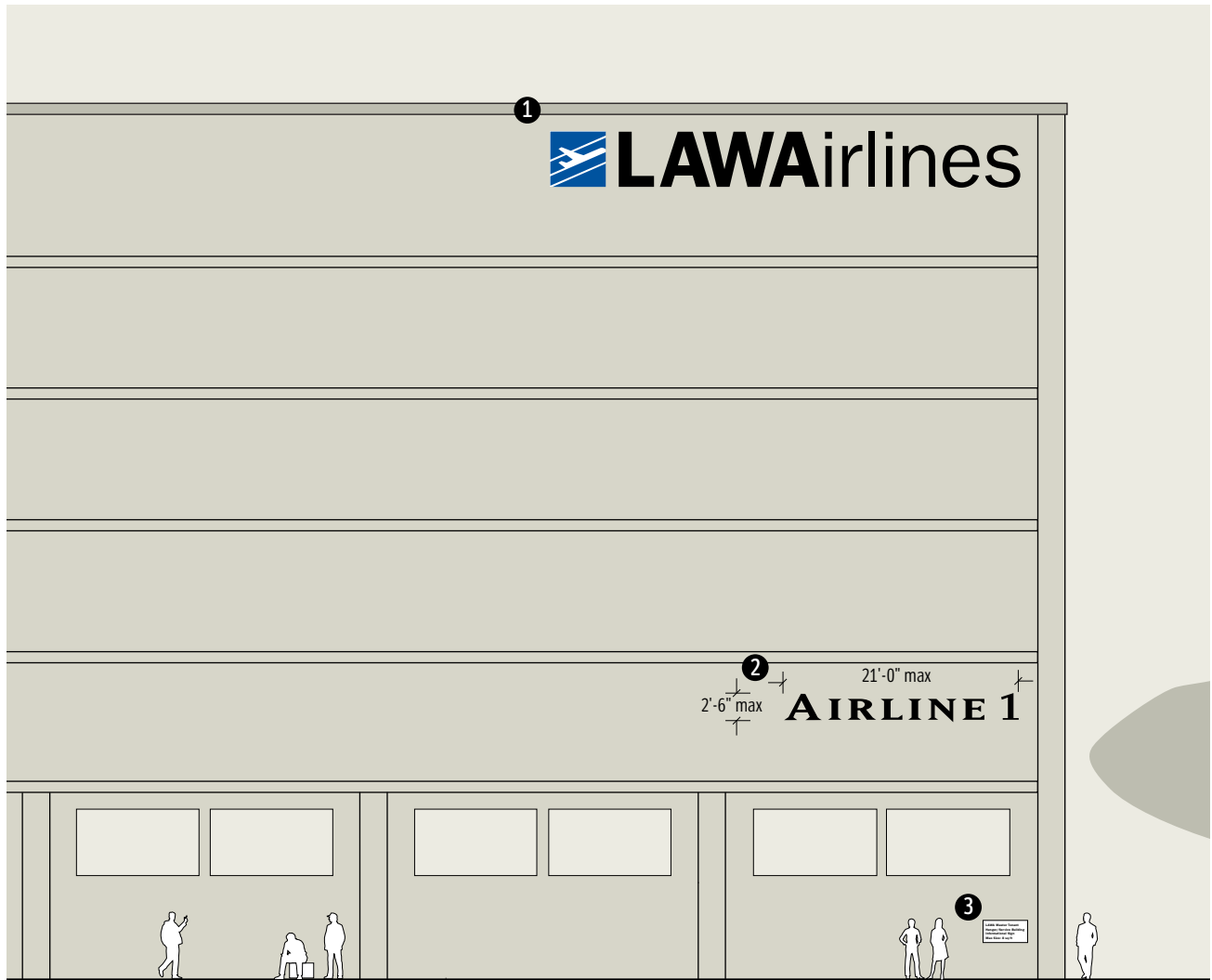

Figure 5h: Multiple Tenant Building

- ① Primary master tenant corporate signature for a structure greater than to 4 stories in height (48+ feet)
- ② Secondary corporate signature
- ③ Regulatory or informational sign

Tenant Status & Corporate Signature Signs

Corporate signature sign dimensions are determined by structure height/width measurements and tenant status.

Signature sign dimensions are calculated in the following charts.

The maximum length of these signs are:

- one-third (1/3) the length of the building frontage for primary signature signs and
- one-sixth (1/6) the length of the building frontage for secondary signature signs.

MASTER TENANT SIGNATURE SIGN SIZES		
STRUCTURE HEIGHT	MAXIMUM SIGN WIDTH	MAXIMUM SIGNATURE HEIGHT
1-2 stories (0-22 feet)	16 feet if building width exceeds 48 feet	2 feet 0 inches
2-3 stories (22-35 feet)	25 feet if building width exceeds 75 feet	3 feet 0 inches
3-4 stories (35-48 feet)	32 feet if building width exceeds 96 feet	4 feet 0 inches
4+ stories (48+ feet)	42 feet if building width exceeds 126 feet	5 feet 0 inches

SUB-TENANT SIGNATURE SIGN SIZES		
STRUCTURE HEIGHT	MAXIMUM SIGN WIDTH	MAXIMUM SIGNATURE HEIGHT
1-2 stories (0-22 feet)	8 feet	1 feet 0 inches
2-3 stories (22-35 feet)	12-1/2 feet	1 feet 6 inches
3-4 stories (35-48 feet)	16 feet	2 feet 0 inches
4+ stories (48+ feet)	21 feet	2 feet 6 inches

Figure 5i: LAWA stipulations for master tenant and sub-tenant signs on hangars and service buildings.

Facilities Signs



*Los Angeles
World Airports*

Los Angeles International Airport



Description

All buildings will have street address numbers and street name visible to the general public. Refer to all applicable municipal codes, including the Los Angeles City Fire Department requirements, before sign submittal to LAWA. LAWA will review these signs on a case-by-case basis.

Location

The address is required at the front of the building facing the street it is addressed to and facing the runway/taxiway if building applies. The address will be a minimum of 8 feet above finish grade and clearly visible from the street.

Sign Image & Text Size

The preferred sign is composed of individually mounted copy. Letter/numeral size is determined as follows.

- Width: must be 1/2 the capital height. The stroke width of any portion must not be less than 1/10 of the height.
- Height: must be 2 inches taller than 1/10 of the street setback distance in feet, as expressed in inches.

Capital Height Formula:

Measure	Distance from street (= total feet)
Convert	Feet to inches (= Total Inches)
Divide	Total Inches divided by 10 (= 1/10 cap. ht.)
Add	Add 2 inches (1/10 cap. ht. inches + 2 inches)
Sum	= Capital Height (inches)

Panel signs are acceptable and will be a maximum size of 2 feet by 1 foot.

Colors & Fonts

There must be at least 70% contrast of value between the address copy and the sign background. A sans serif font is required. The preferred font is the LAX standard exterior wayfinding font.

Materials

Acceptable materials are polished or brushed metal, painted aluminum or acrylic.

Quantity

- One (1) sign at the front of the building facing the street.
- One (1) sign on the building frontage facing the runway if necessary.

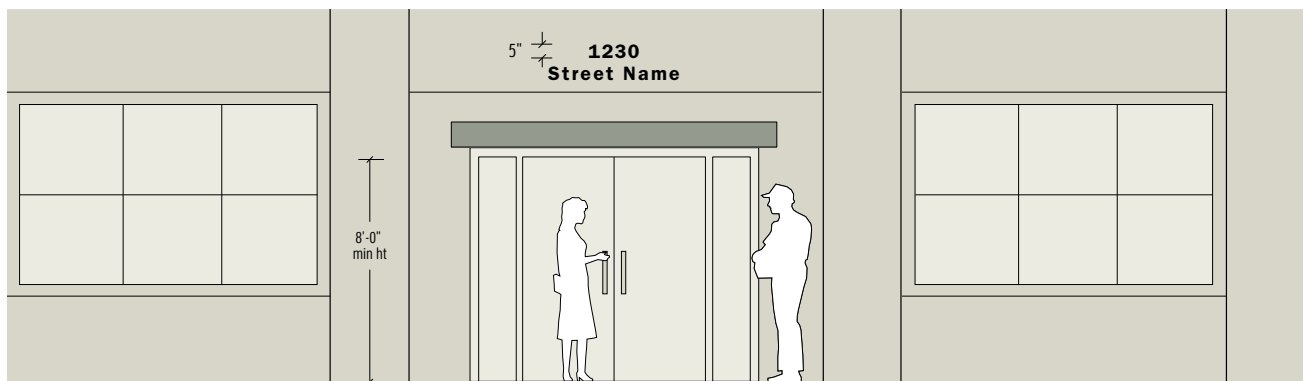

Figure 6a: Address size for a building set back 30' from the street (30' = 30" | 30" ÷ 10" = 3" | 3" + 2" = 5").

Description

Each air freight complex and/or building is permitted one monument directory sign at the primary entrance to the site, or inclusion on an existing directory sign at LAWA's discretion. A new sign must be clearly visible from the street and passing vehicular traffic from both directions. These signs will be reviewed by LAWA on a case-by-case basis.

Location

A directory sign may be erected as a freestanding monument at the facility's vehicular entrance

Sign Size

- A. Building complex or multiple tenant building: maximum sign area is 60 square feet.
- B. Single structure with major tenant with a maximum of 2 sub-tenants: maximum sign area is 32 square feet.

Image & Text Size

Primary corporate signatures are limited to 8 inches in height. Master tenant text messages are limited to

a maximum capital height of 8 inches. Sub-tenant text messages are limited to a maximum height of 3-1/2 inches

Colors & Fonts

- ① Corporate signature images, fonts and colors are acceptable for master tenant sign directories only.
- ② Sub-tenant signs on directories must not use corporate signature images, fonts and colors. A common sans serif font and color for all sub-tenant entries is required. Use the LAX exterior wayfinding font whenever possible.

Materials

Materials selection must be submitted for review by LAWA. Preferred construction materials are aluminum and acrylic.

Quantity

- A. A maximum of one (1) directory monument per building complex is permitted.
- B. A maximum of one (1) directory monument per building is permitted.

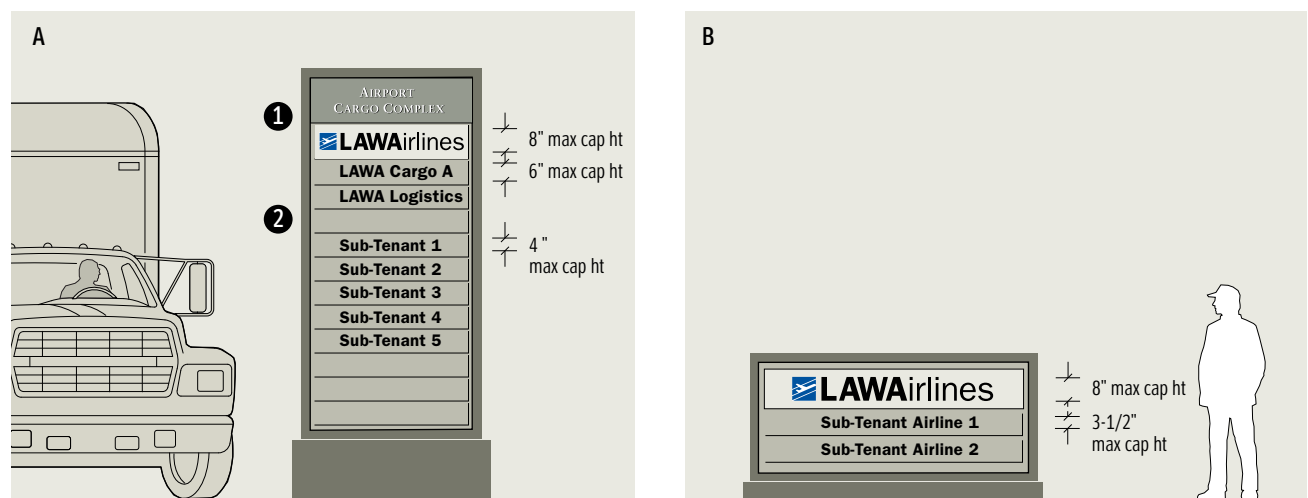

Figure 6b: Monument signs direct vehicle traffic at the complex site and individual building entrances.

Description

Where a directional sign is needed to guide vehicle traffic and no monument directory is installed, each tenant is permitted to attach one (1) sign as needed to a fence under LAWA jurisdiction. These signs will be reviewed by LAWA on a case-by-case basis.

Location

Fence signs will be firmly attached to fence supports where possible. Sign tops must align at a height of 7 feet when possible.

Sign Size

The sign will be a maximum size of 3 feet wide by 2 feet, 6 inches high and not more than a total area of 7.5 square feet.

Image & Text Size

The sign copy will be limited to the tenant's corporate signature and minimal directional information and directional arrows. The signature

will not be longer than 75% of the sign width. Text messages are limited to a maximum capital height of 3-1/2 inches. No colored borders or other graphics are allowed.

Colors & Fonts

- The background of the sign must be white.
- The image and text of the corporate signature colors are acceptable.
- Fonts for informational text should follow the tenant's corporate standards or use the LAX exterior wayfinding font.
- Informational text must be black.

Materials

Approved construction materials are painted aluminum with screened or vinyl copy on a non-illuminated panel.

Quantity

One (1) sign per tenant.

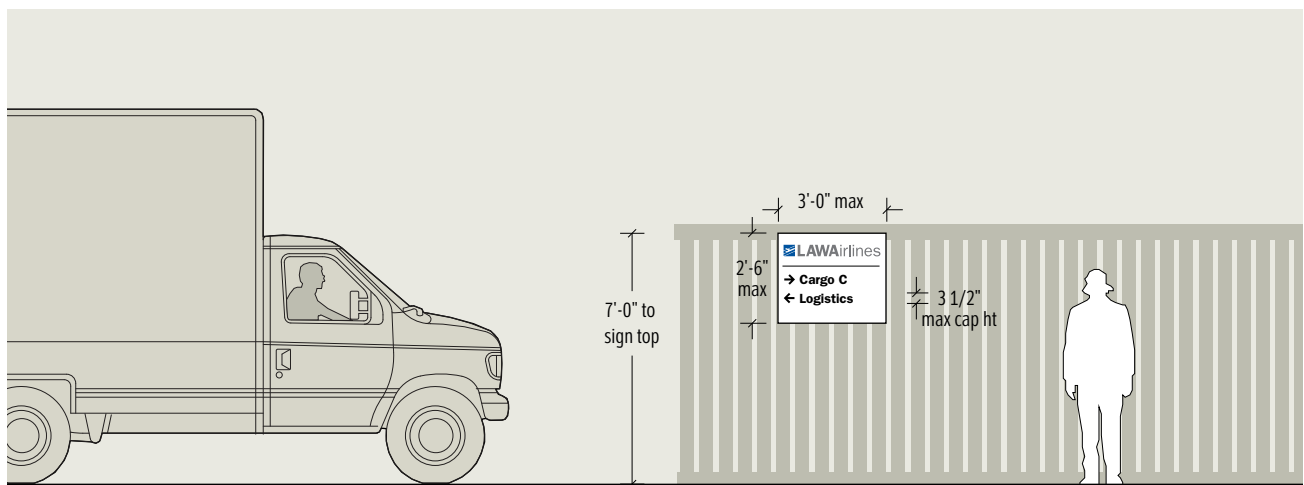

Figure 6c: Fence signs are permitted but not desired.

Description

Each tenant is permitted to display a non-illuminated directional sign for vehicle traffic when no other directional signs exist. These signs will be reviewed by LAWA on a case-by-case basis.

Location

A directional sign may:

- ❶ be erected as a freestanding post sign
- ❷ be attached to a fence, or
- ❸ be attached to the exterior walls on the shipping dock side of the tenant's own building (with the written approval of all other building occupants).

Sign Size

The maximum sign sizes are:

- ❶ 3 feet wide by 4 feet high
- ❷ 3 feet wide by 2 feet, 6 inches high
- ❸ 3 feet by 4 feet.

Image & Text Size

The sign copy will be limited to the tenant's corporate signature and minimal directional information and directional arrows. The signature will not be longer than 75% of the sign width. Text messages are limited to a maximum capital height of 3-1/2 inches. No colored borders or other graphics are allowed.

❶❷ See *Figures 6d*. ❸ See *Figure 6e*.

Colors & Fonts

- The background of the sign must be white.
- The image and text of the corporate signature colors are acceptable.
- Fonts for informational text should follow the tenant's corporate standards or use the LAX exterior wayfinding font.
- Informational text must be black.

Materials

Approved construction materials are painted aluminum with screened or vinyl copy on a non-illuminated panel.

Quantity

One (1) sign only per tenant. Whenever possible, master and sub-tenants will combine all information on one sign to eliminate redundancy.

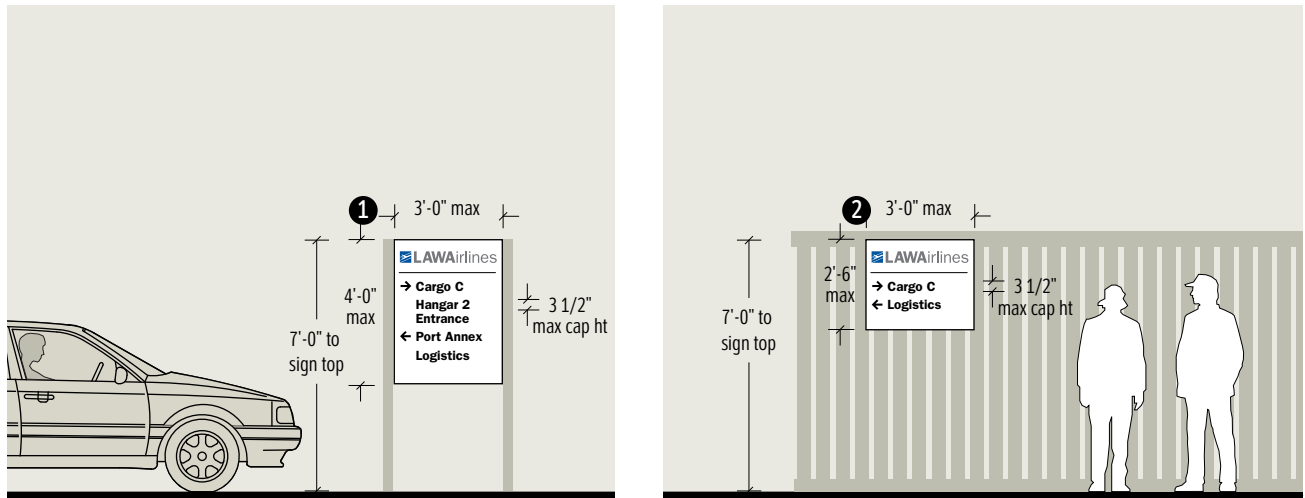

Figure 6d: Directional signs guide vehicular traffic to tenant buildings when other such signs do not exist.

- ① Post and panel type directional sign
- ② Fence sign



Figure 6e: Directional signs attached to tenant buildings are acceptable but not preferred.

- ③ Panel directional sign attached to exterior wall

Terminal and Door Numbering



*Los Angeles
World Airports*

Los Angeles International Airport

Overview

These guidelines were developed to provide a consistent door numbering system that will be utilized airport wide. They are based on the MAXIMO database system developed as a way of tracking airport assets.

Background

Throughout the years, Los Angeles International Airport (LAX), in response to public demand, constructed a number of different terminals. Each terminal utilized its own door numbering system. As the airport continues modernization efforts, LAWA is moving toward standardized approaches to building systems, including room and door numbering.

A separate exterior “front door” numbering system (shown in Diagram 08) has been developed and installed that specifically addresses the needs of first responders.

Rules

1. The proposed door numbering system is based on the MAXIMO naming conventions assigned to rooms in order to maintain a “family” of naming sequences. While based on MAXIMO, this is a system of door numbering that focuses on public usage.
(Refer to Diagram 01)
2. The fonts used for the door numbers will consist of a combination of Helvetica Medium and Helvetica Heavy. The heavy font will be approximately 2.25 times the height of the medium font.
(Refer to Diagram 01)

3. Doors will be numbered in a clockwise direction on both sides of door. Door numbering on the inside of doors shall be display on door tags only.
(Refer to Diagram 02)
4. In any given area, the starting point is determined by the door that is in closest proximity to the main public entrance along the street in the central terminal area (CTA). The starting point should also be close to a group or cluster of doors rather than an isolated door to establish sequential door numbering that is obvious to all.
(Refer to Diagram 02)
5. Doors that LEAD FROM a corridor/path into rooms or other areas will be assigned the designation already assigned by MAXIMO.
(Refer to Diagram 02)
6. Doors located along the length of a corridor will be assigned sequential designations.
(Refer to Diagrams 02 & 04)
7. No sub-room door designations will be added to the numbering string, rather a designation using a simple capital letter such as “A”, “B”, “C”, “D”, etc. will be used.
(Refer to Diagram 03)
8. When a space has two or more door entrances from an interior corridor, the doors shall have the same designation plus an additional lower case letter.
(Refer to Diagram 04)

Exceptions

- Doors that lead from a sector/passageway to a jet bridge will be assigned the Gate number/naming convention.
(Refer to Diagrams 01)
- Doors along a sector/passageway *THAT RUN CROSSWISE* but do not open into rooms or interior spaces will be assigned the sector/passageway designation. These doors will display the terminal number, level, sector/passageway followed by a period and a lower case alpha character.
(Refer to Diagrams 05)
- Doors *ALONG* a sector/passageway that open to the airfield will be assigned the sector/passageway designation.
(Refer to Diagrams 06)

Steps:

1. Obtain map related to the project scope from LAWA GIS Division with MAXIMO numbering designations displayed on the map indicating sectors, passageways and rooms.
2. Abbreviate the MAXIMO numbering designations for display on door plates and on door tags. Refer to the “Los Angeles World Airports Terminal Wayfinding Standards” for door plate description and drawing.
3. For door tags: add an additional lower case “.a”, “.b”, “.c”, “.d”, etc. to indicate the door number (as opposed to the room number) for LAWA Maintenance quality control purposes.

Abbreviated MAXIMO number displayed on door tag:

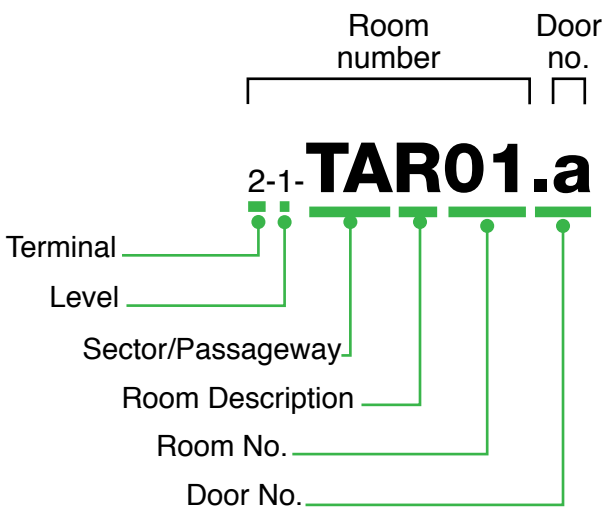

Final door tag will display the numbering sequence in white on a PMS 661 dark blue field:



Helv. Neuv. Hvy. / Helv. Reg

Original MAXIMO number:

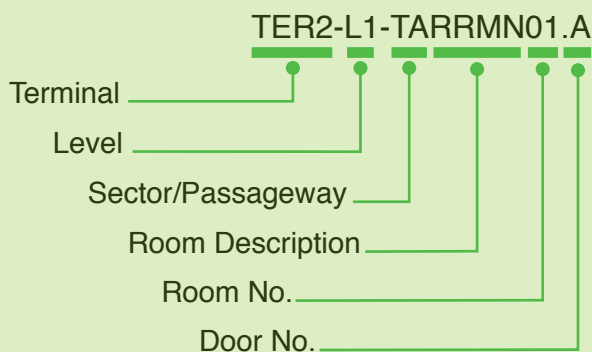

The following example depicts how terminal ROOM NUMBERS supplied by the LAWA GIS Division is abbreviated for display on the door tags and door plates:

(Diagram 01)

Example of a MAXIMO designation with descriptions for the sequence:

TER02.L1TARRMN01.a

**TERMINAL 2, LEVEL 1, TICKETING SECTOR,
PASSAGEWAY A, ROOM DESCRIPTION, DOOR 01,
PRIMARY DOOR “.a”**

**(this condition always exists to identify a door from
a room. Subsequent doors will be identified with a
lower case “.b”, “.c”, “.d”, “.e”, etc.)**

For door tag numbering string apply the following:

- The terminal (expressed as a single digit) followed by a dash
- The floor level (expressed as a single digit) followed by a dash
- The MAXIMO sector and MAXIMO passageway
- The room description, if any (expressed as single or double letters) Refer to page 14 for a list of abbreviations.
- The two-digit door number
- Concluding with an “.a”, “.b”, “.c”, “.d”, etc. for all doors associated with a room.

2-1-TAR01.a

For illustration purposes only, colors are used to describe the end state of the door tag shown below.

Final door tag will display the numbering sequence in white on a PMS 661 dark blue field:

2-1-TAR01.a

Helv. Neuv. Hvy. / Helv. Reg

(Diagram 02)

The map below displays sector, corridor, room and door numbers similar to those supplied by LAWA GIS Division and derived from MAXIMO. All door tags and plates display an abbreviated version of the MAXIMO naming conventions supplied by LAWA GIS Division.

For door tag numbering string, follow the steps described on page 6.

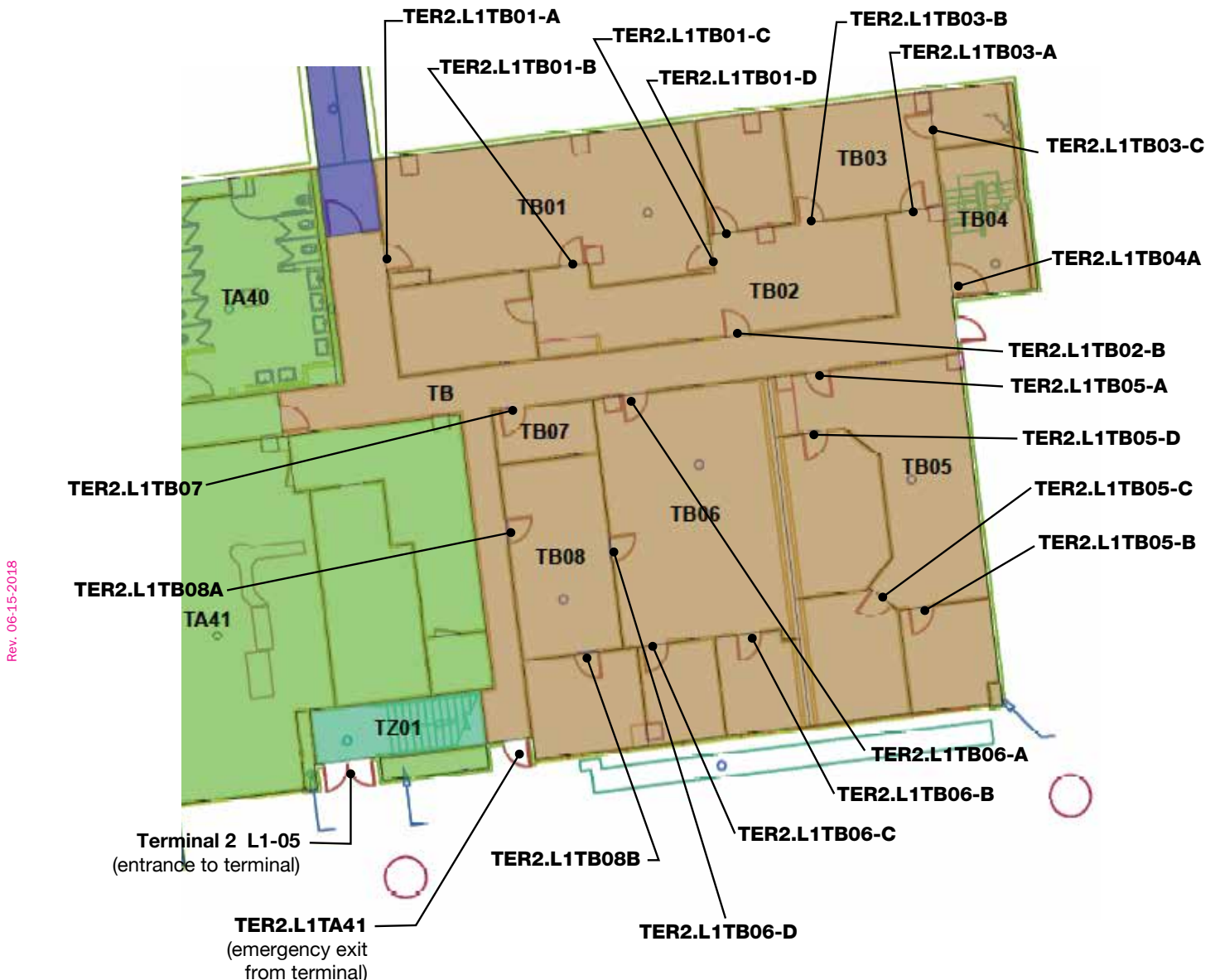

Rev. 06-15-2018

(Diagram 03)

Door tag numbers derived from previous page:

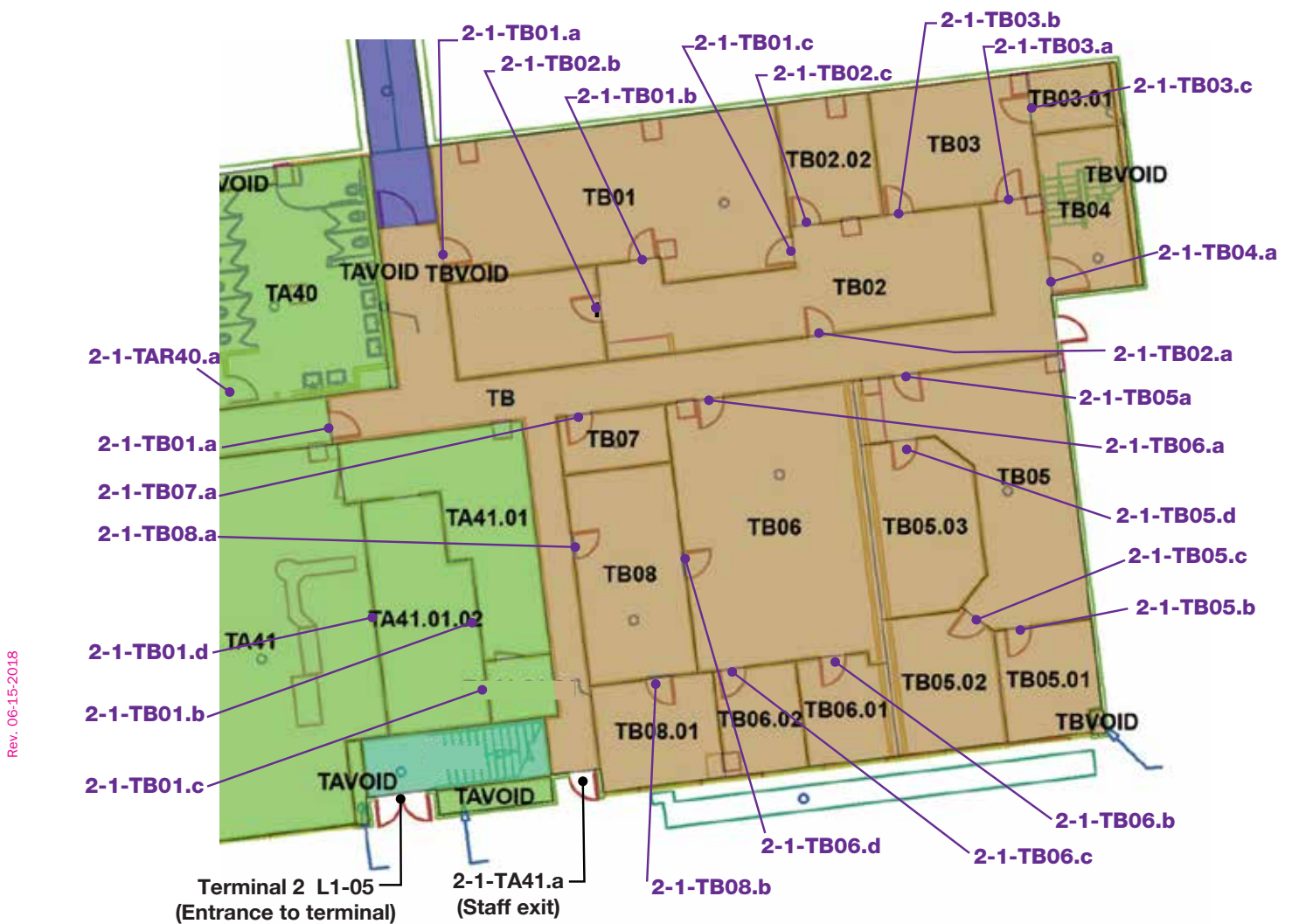

(Diagram 04) Door Numbering Process

The map below displays sector, corridor, room and door numbers similar to those supplied by LAWA GIS Division and derived from MAXIMO. All door tags and plates display an abbreviated version of the MAXIMO naming conventions supplied by LAWA GIS Division.

All doors, including subroom doors are designated with a lower case letter such as “.a”, “.b”, “.c”, “.d”, etc. and included in the numbering string.

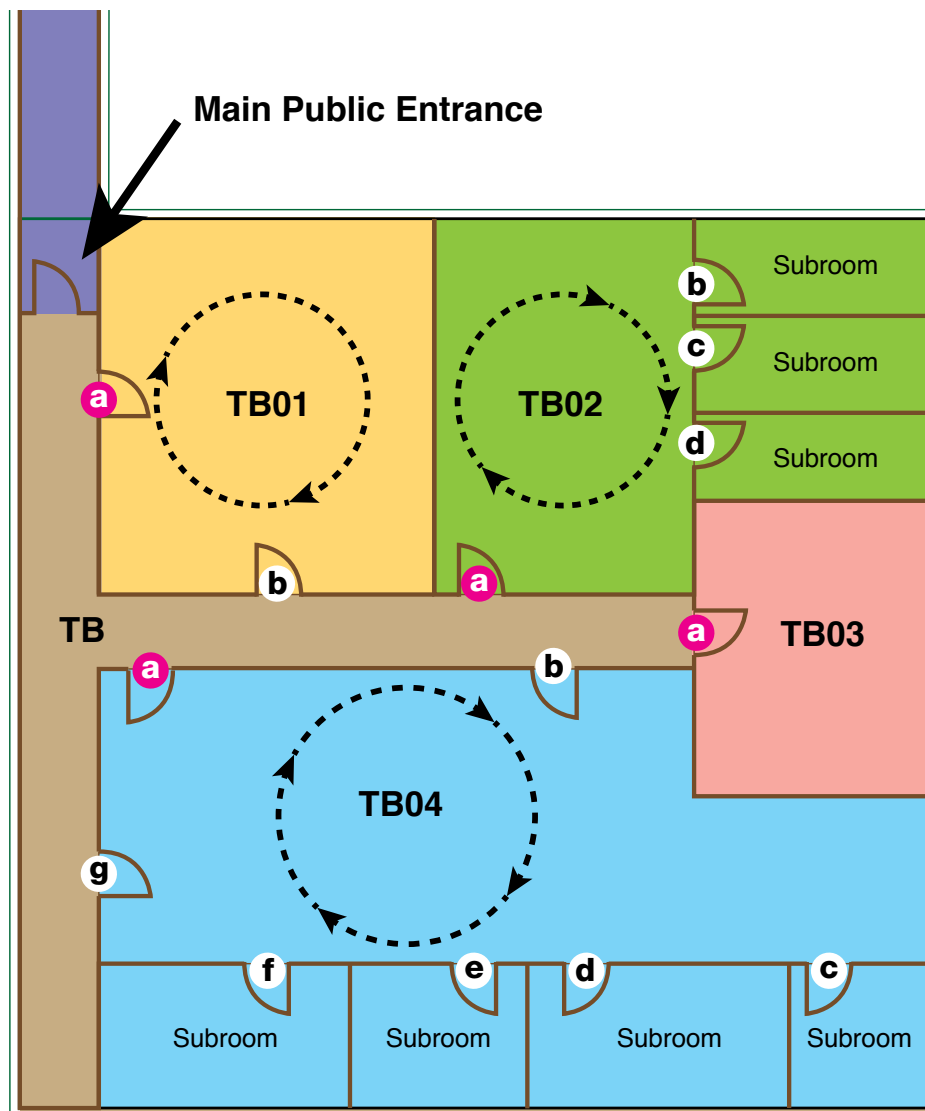

Rev. 06-15-2018

(Diagram 05)

All doors, including subroom doors are designated with a lower case letter such as “.a”, “.b”, “.c”, “.d”, etc. and included in the numbering string.

The door numbering process begins at the door that is in closest proximity to the main public entrance and in close proximity to a group of doors so that a sequence of numbers can be established in a clockwise direction.

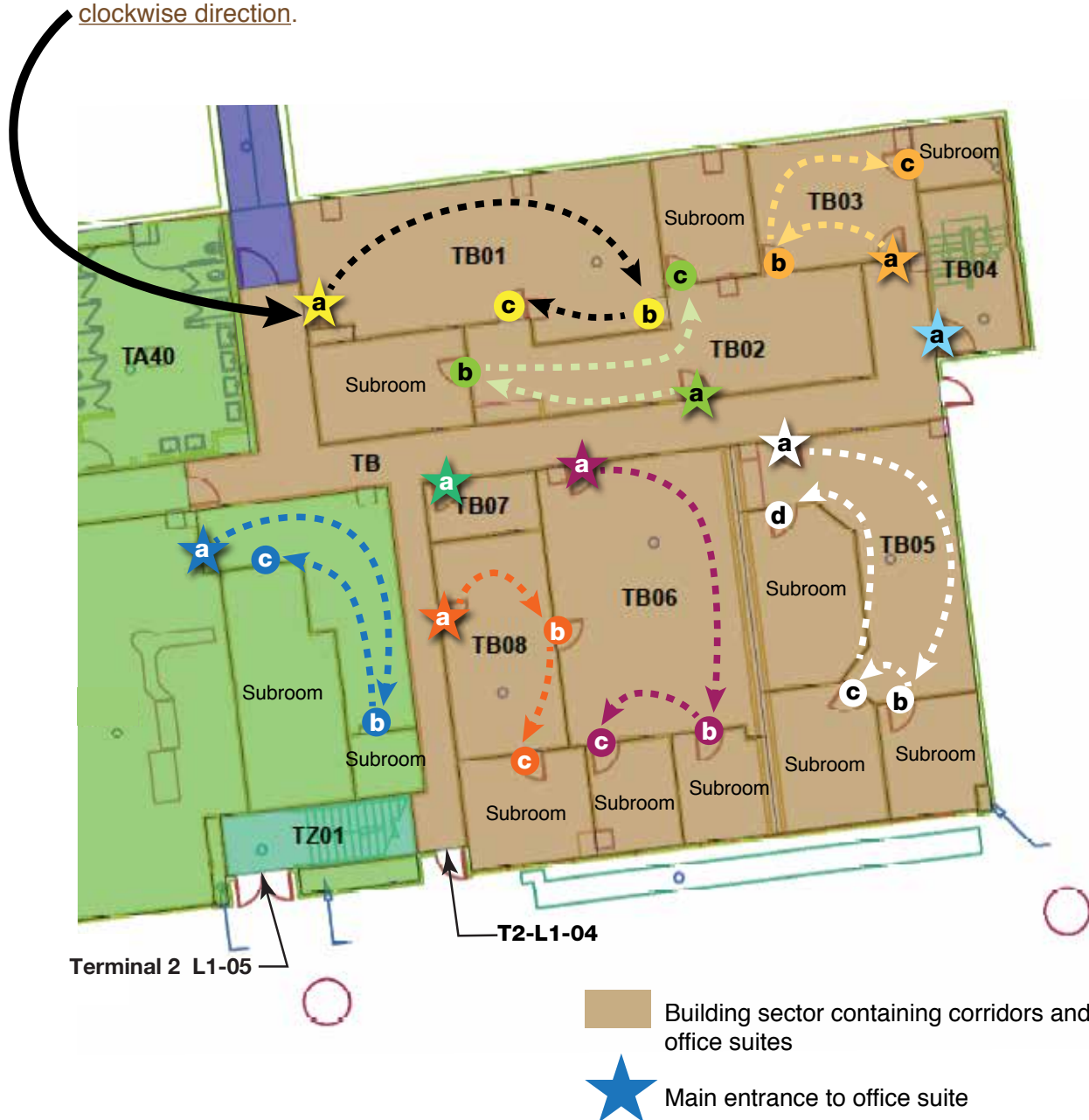

Rev. 06-15-2018

(Diagram 06)

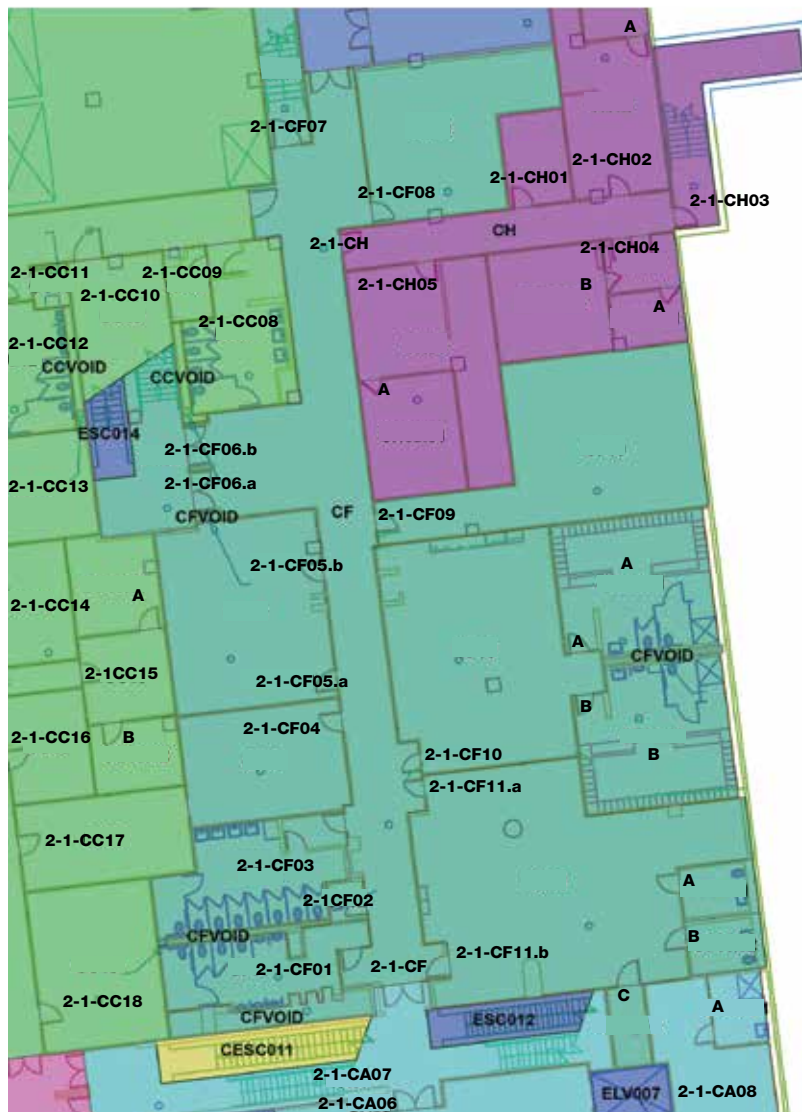
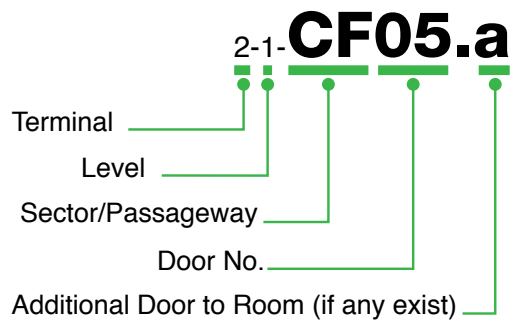

Rev. 06-15-2018

The terminal address is pin mounted, fabricated in stainless steel and installed on both arrivals & departures levels. These signs must be compliant with ADA code.

The terminal number, level and door numbers are mounted above the doors and fabricated in white vinyl.

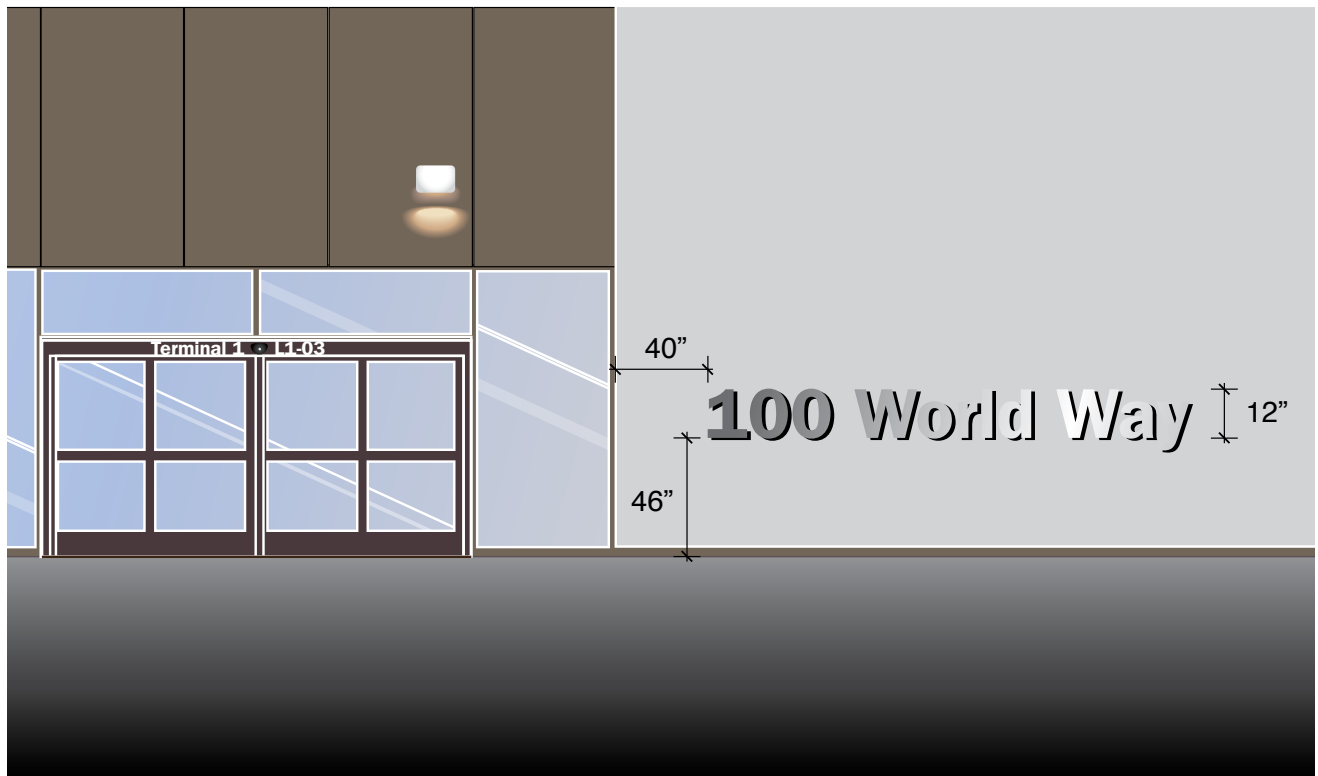
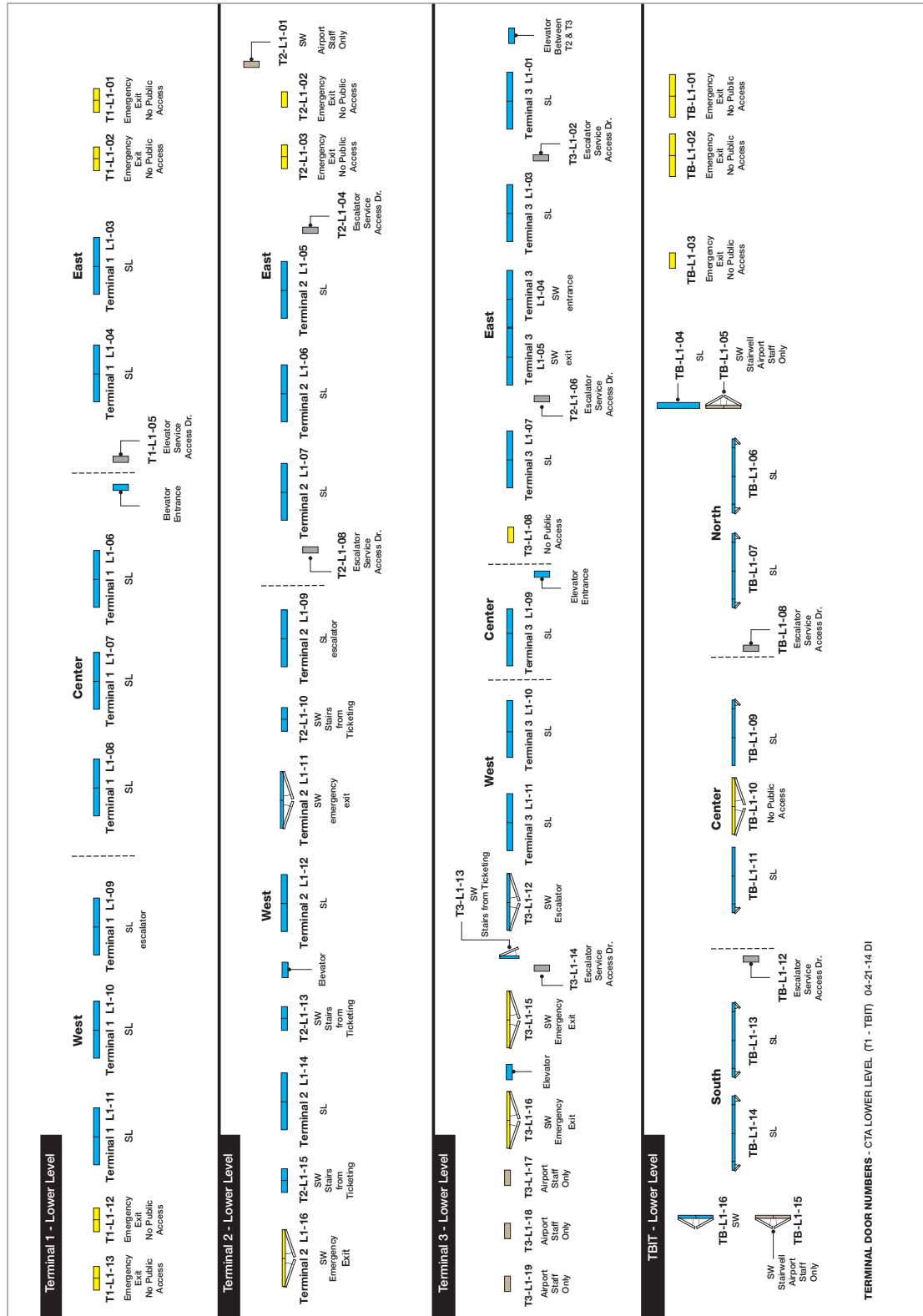

Diagram 07
Terminal 1, Departures Level

Rev. 11-03-2016

Rev. 09-01-2016



Terminal 1-TBIT, Arrivals Level

Rev. 09-01-2016

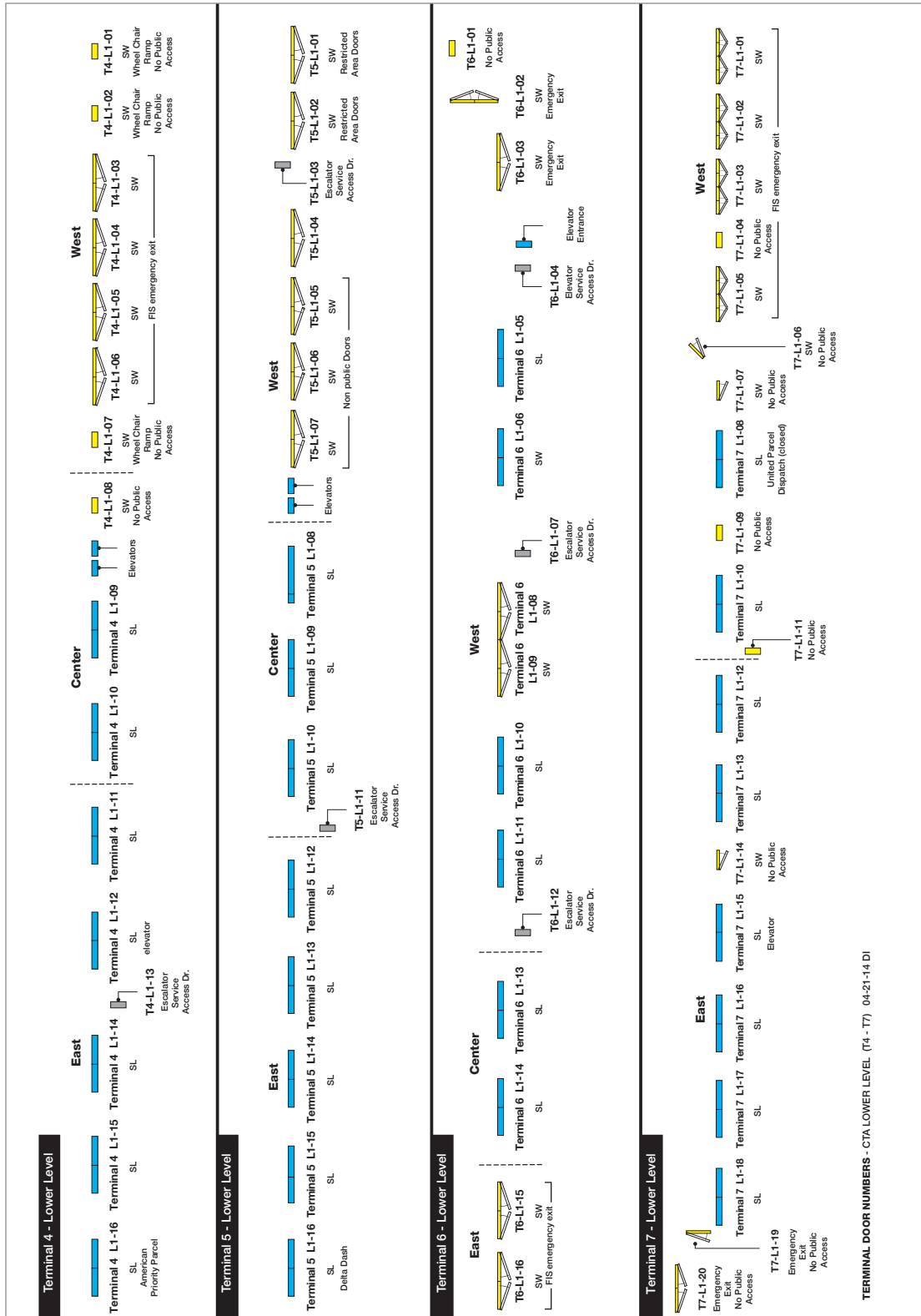

Terminal 4-7, Arrivals Level

Rev. 09-01-2016

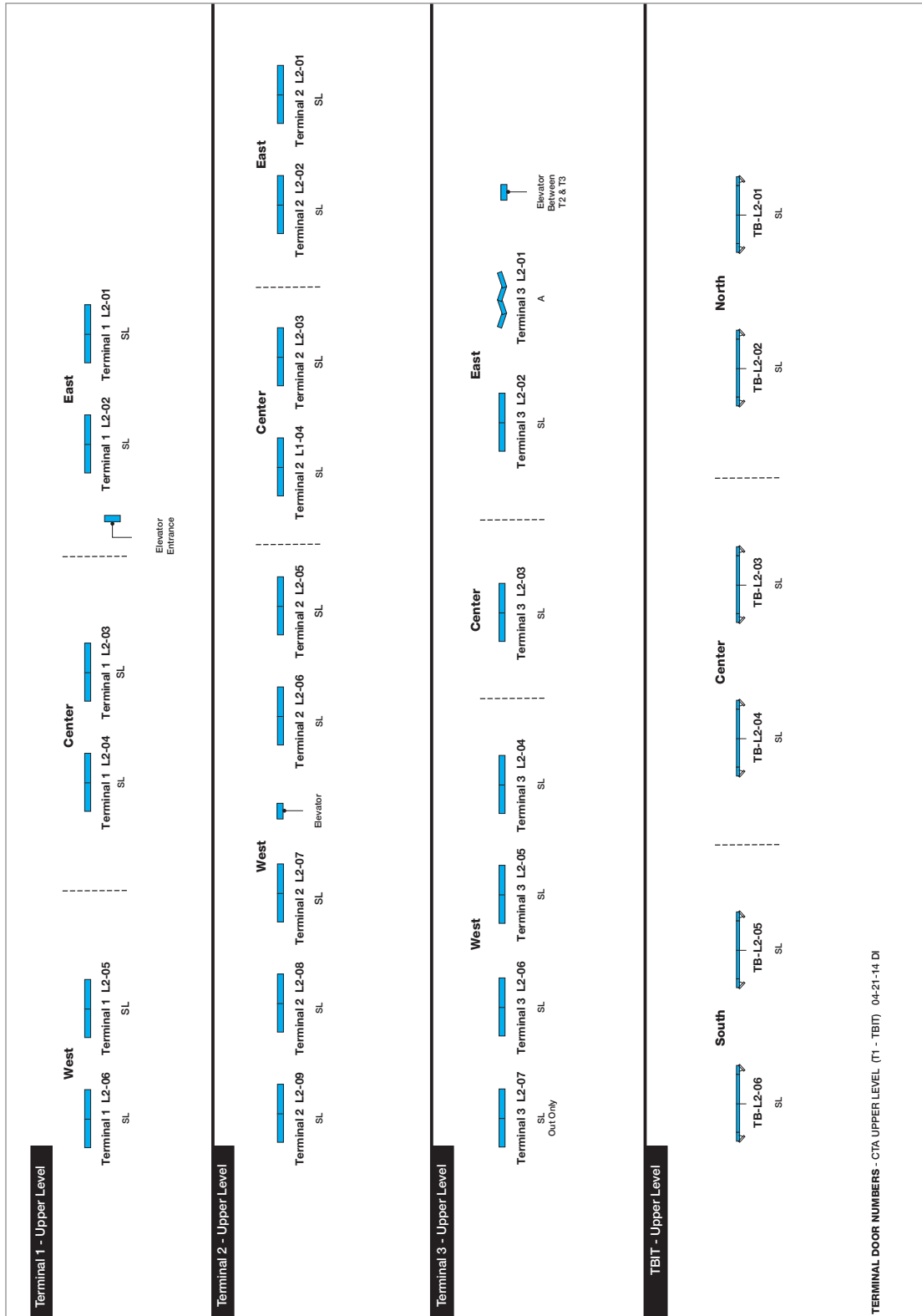

Terminal 1-TBIT, Departures Level

Rev. 09-01-2016

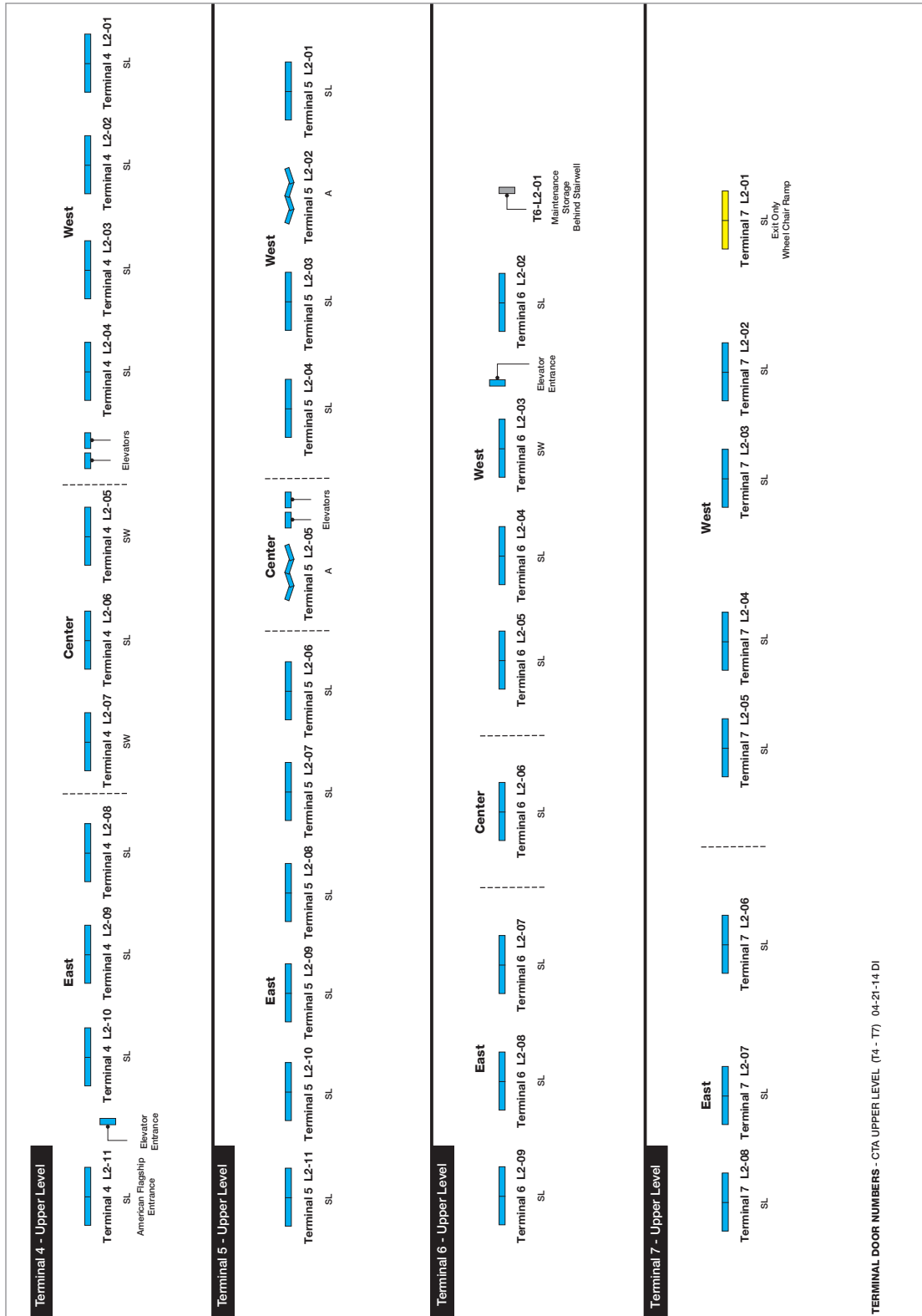

Terminal 4-7, Departures Level

Terminal Stair Numbering



*Los Angeles
World Airports*

Los Angeles International Airport

Overview

1. This guideline provides a stair numbering system for each terminal building in the Central Terminal Area (CTA) of Los Angeles International Airport (LAX).
2. The objective of this numbering system is to establish a standardized approach for designers, architects, engineers and contractors to follow.
3. Stakeholders to benefit from this standardized stair numbering system will consist of, but not be limited to:
 - a. Los Angeles Fire Department (LAFD)
 - b. Airport Police Department (APD)
 - c. LAWA Emergency Management Division, Facilities and Technical Services Division (FTSD)
 - d. Planning and Development Group (PDG)
 - e. Geographic Information Services (GIS) Support Services Division
 - f. Maximo.

Guidelines

1. All signs shall match Wayfinding and Signage Standards found in the Design and Construction Handbook (DCH). Stair numbers shall be displayed on Stair Identification and Evacuation Plan signs. (See Figures 1 and 2)
2. Stairs shall be numbered in a clockwise direction from the centermost, front of each terminal beginning at the central axis of the pier. (See Figure 3) Numbering shall take into account each accessible level.
3. Sequential stair numbering shall design for a gap to allow future renovations. As shown in Figure 1 gaps occur for all the 9's (i.e., 9, 19, 29, 39, etc).

Approval from LAWA

1. Submit plans showing the stair numbering schema for each floor to LAWA Graphics and Signage department for review and approval.



Figure 01: Evacuation Map



Figure 02: Stair Identification

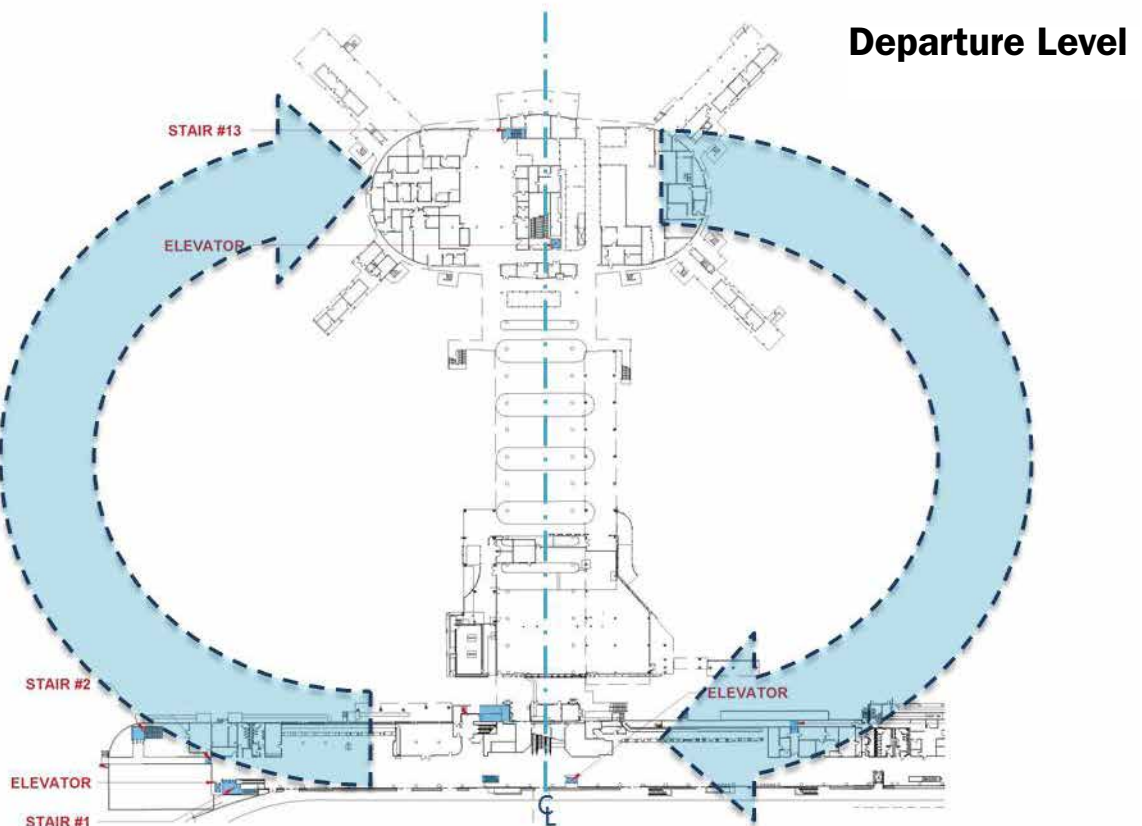
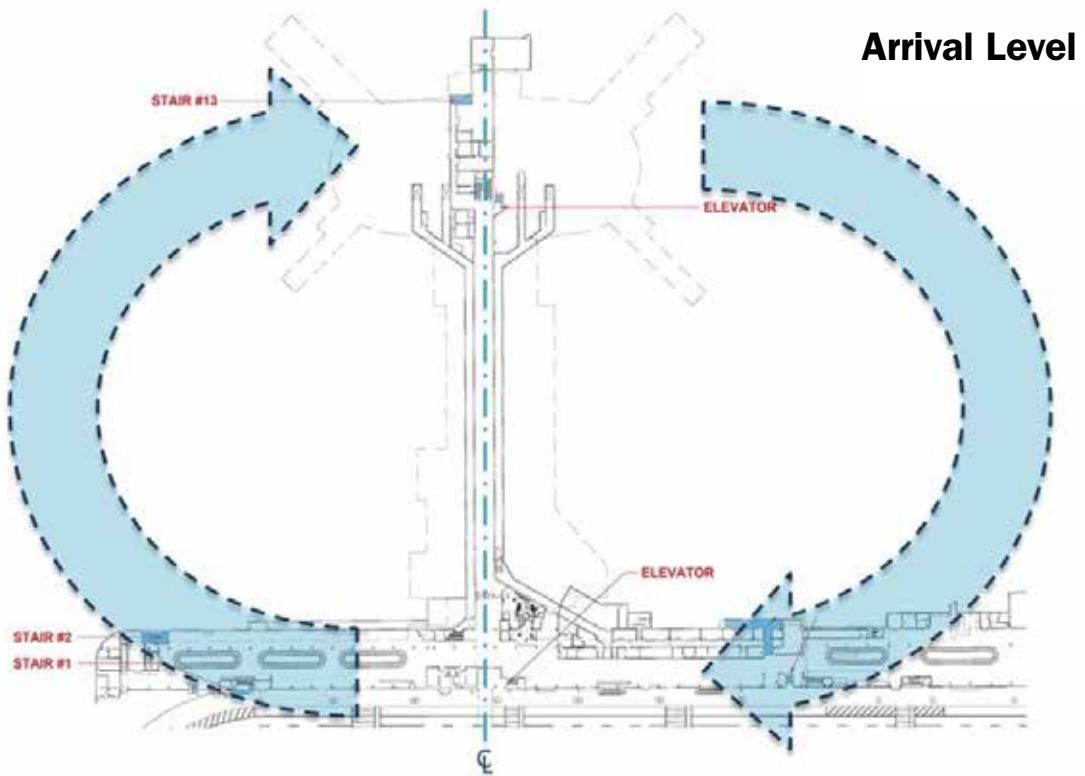

Figure 03

New 08-22-2018

Concourse Level

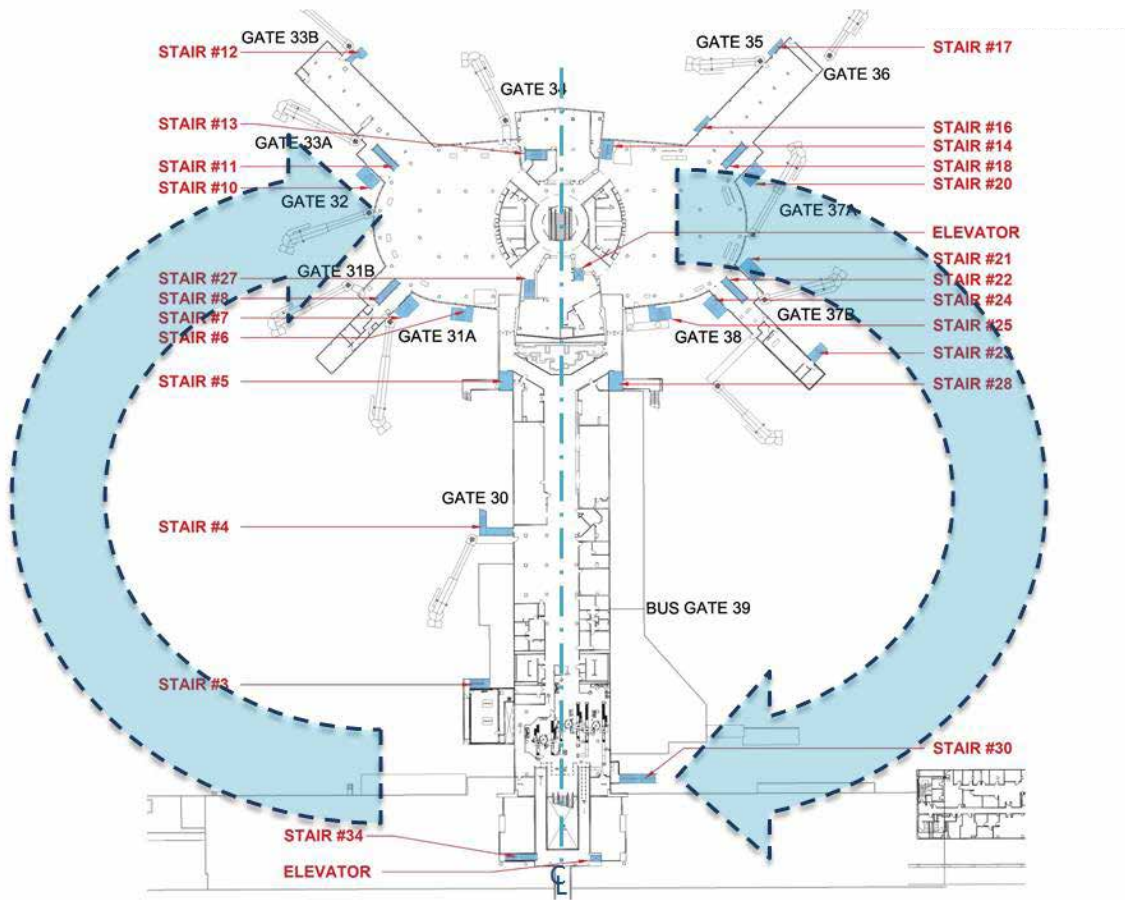

Figure 03 (continued)

New 08-22-2018

Design Review Process



*Los Angeles
World Airports*

Los Angeles International Airport



Step 1 – Conceptual Design Submittal

The Tenant will submit to LAWA’s Commercial Development Group (CDG) a written description of the type of sign and/or graphics proposed for their selected space. A set of renderings or elevation to scale must be included. Drawings should be on a minimum sheet size of 11” x 17”. While Computer-Aided Drafting (CAD) drawings are not required for the Concept Development submittal, they will be required for all other construction drawings.

Submissions must be addressed to:

Commercial Development Group
Los Angeles World Airports
6053 W. Century Boulevard, Suite 400
Los Angeles, CA 90045
Tel: (424) 646-7200
Fax: (424) 646-9256

CDG will assign a Business Relations Manager (BRM) who will guide them through the development and implementation of the proposed sign. A single representative for the Tenant will be responsible for communicating with the Business Relations Manager.

A copy of the LAX Master Lease Exhibits (MLE) will be provided for the impacted area. The MLE are for the Tenant’s information only. The Tenant must coordinate with the Business Relations Manager to research and obtain the specific Architectural and Engineering Record Drawings located in the Engineering Facilities Management Division, Reprographics Group.

Conceptual Design Submittal Check List

The Tenant will submit a digital file of the Conceptual Design. The following is a draft list of items required and is subject to change:

1. Concept Request Form.
2. One (1) Site Plan or Terminal Lease Plan showing the location of the proposed concession/improvements.
3. At least one (1) photo showing the existing conditions.
4. One (1) color rendering or elevation(s) of the conceptual design identifying materials and architectural elements. (scale: 1/4” = 1’-0”)

When requested, the Tenant will present the Conceptual Design to LAWA staff for review and approval. The Conceptual Design will be submitted to LAWA within the time frame negotiated or stated in the Tenant’s agreement. Written comments will be provided to the Tenant. The Tenant will revise the design, incorporate comments received from LAWA, and resubmit for review and approval. Allow approximately 2 to 3 weeks for LAWA CDG to issue a concept approval letter to the Tenant upon receipt and acceptance of the submittal. No work will begin on developing Design and Construction Documents without Notice to Proceed (NTP).

Step 2 – Design Development & Construction Documents

The Tenant will formally issue a complete digital file of CAD drawings to LAWA with an accompanying Cover Letter addressed to the Project Manager.

The Cover Letter will identify the project, indicate the Submittal being issued, scope of work, design approval comments incorporated, if applicable, and a list of all the drawings included with submittal.

All drawings will be to scale and should include, but are not limited to the following:

Drawing Description	Scale
Site Plan	As Appropriate
Elevations	1/4" + 1'-0"
Finish Schedule and Details	As Appropriate

LAWA's review of the Design Development and Construction Document Submittals will include, but are not limited to, the following topics:

- **Overall Design Compatibility with Each Terminal's Architectural Features**
Fulfillment of LAWA Design and compliance with the Tenant Signage Guidelines.
- **Interface with Public Areas**
The Tenant design bordering public areas will conform to the lease-specified vertical and horizontal requirements, and coordinate with adjacent concessions.
- **Code Compliance**
Design will comply with all applicable local, state, and federal laws, codes, and ordinances and other government agency requirements. The Tenant is responsible for submitting documents directly to other government agencies.

- **Sustainability**
LAWA encourages the use of environmentally responsible materials and finishes. Wood-based materials and products should be certified in accordance with the Forest Stewardship Council's Principles and Criteria for wood building components. The Tenant should identify space for the collection and storage of recyclable materials such as paper, corrugated cardboard, glass, plastics and metals.
- **Compliance with LAWA's Sign Policy/Guidelines**
The Construction Documents will be submitted to LAWA within the time frame negotiated or as stated in the Tenant lease agreement. Allow approximately 2 to 3 weeks for LAWA EPMD to review and approve Tenant's Design Submittal. If the Design Submittal is not approved, the Project Engineer will issue LAWA's review comments to the Tenant. The Tenant will correct and/or revise drawings, as required, and re-submit the package for LAWA Approval. The Tenant will obtain LAWA's Construction Approval in writing before any construction activities may begin.

Tenant Construction

Construction in Tenant areas will not begin until an approved building permit has been secured from the City of Los Angeles Department of Building and Safety and written approval is received from LAWA. When ready to begin construction, the Tenant will notify the Project Engineer who will schedule a pre-construction meeting.

Glossary



*Los Angeles
World Airports*

Los Angeles International Airport

Advertising

The action of calling something to the attention of the public to promote a product or service.

Architectural Element

A vertical face, breaking up the horizontal face of the facade of a building or structure.

Area

LAWA subdivides each airport campus into areas. The combination of campus designation and area designation defines the general location of a facility.

Box/Can Sign

A metal, fiberglass, plastic or wood enclosure with a translucent sign panel illuminated from within. This includes any variation of individually canned letters or combination with box sign.

Building

A facility that has a roof, walls and a defined location.

Campus

Los Angeles International Airport (LAX), Ontario International Airport (ONT), Van Nuys Airport (VNY) and Palmdale Regional Airport (PMS) are referred to as campuses.

Canopy

A horizontal overhang.

Capital Height (Cap. Ht.)

The distance from the top of a capital letter form to the bottom of the same letter form.

Clerestory

A break in a roof or ceiling system where two roofs or ceilings meet at different levels, creating a vertical space that may have windows.

Column Names

Location referencing names applied to building's structural columns. This definition does not consider column labels used with building design drawings or as-built documents.

Construction Sign

Any sign necessary during construction to meet regulatory and safety standards, guide and direct visitors and staff, as well as general information.

Copy

Text, artwork, photos or drawings to be reproduced.

Corporate Signature

The company's name in recognized style and form, and/or the company's logo.

Cubicle

A partially enclosed workspace, separated from neighboring workspaces by partitions.

Display

A three dimensional or graphic device whose purpose is to promote a product or service.

Demising Line

The line separating the adjoining lease spaces or public common areas.

Fascia

Outside, horizontal element on a cornice.

Freestanding Sign

Any sign for which the primary structural support is not a building, and which has as its primary support a post, pole or other structure which is anchored to, attached to, or standing directly on the ground.

Header

That portion of the building which is an architectural element running above the demising line.

Level

The position of a floor within a building. Roofs have a specific designator (ROF) for the highest level of the building.

Logo

Symbol, single letter or icon representing a business or product.

Logotype

Lettering or name representing a business or product

Non-Conforming Sign

A sign which has been previously permitted by the Los Angeles World Airports, but which does not conform to present signage standards.

Non-Permitted Sign

Any sign which has been installed by a tenant for which no permit has been obtained.

Passageway

An interior or exterior corridor connecting sections of a building. Passageways provide access to rooms and sometimes other passageways. They use a single alpha character. The alpha character Z is reserved to designate outdoor passageways and rooms being accessed off an outside passageway. The alpha character 'I' will not be used to avoid confusion with the number 1 (one).

Room

A space that can be accessed by a door and is enclosed by a floor, walls and a ceiling.

Sector

Major segments of terminal buildings defined by common circulation or use criteria.

Sign

An element whose purpose is to guide, direct and inform.

Sign Area

The area of the sign will be considered to be the area of the smallest rectangle, circle or triangle which can be circumscribed around all words, letters, figures, symbols, designs and framing devices that form an integral part of the sign.

Storefront

The front boundary plane (demising line) of each tenant’s space, separating the tenant from the public access way, and limited by the floor and respective finished face or header above and between the vertical demising lines on either side.

Sub-Room

Typically rooms that can only be accessed from another room. Exceptions to this are subordinate rooms that have a door opening into a sterile corridor or to connecting tunnels.

Temporary Sign

A sign visible for not longer than forty (45) days.

Text

The message in words that appears on a sign.

For your reference, some definitions already created in MAXIMO